



Rainwater Harvesting as a
Development-Wide Water Supply Strategy

Final Report
Submitted to The Texas Water Development Board (TWDB)

(TWDB Contract No. 1148321311)

Submitted to the Texas Water Development Board
October 25, 2013

By David Venhuizen, P.E.
Venhuizen Water Works

Karen Ford,
White Hat Creative

&

Meredith Miller, Stacy Bray, Shaun Payne and Andrew Sansom
The Meadows Center for Water and the Environment,
Texas State University – San Marcos
(formerly River Systems Institute)

2013 OCT 28 AM 8:08
CONTRACT ADMINISTRATION



Rainwater Harvesting as a
Development-Wide Water Supply Strategy

Final Report
Submitted to The Texas Water Development Board (TWDB)

(TWDB Contract No. 1148321311)

Submitted to the Texas Water Development Board
October 25, 2013

By David Venhuizen, P.E.
Venhuizen Water Works

Karen Ford,
White Hat Creative

&

Meredith Miller, Stacy Bray, Shaun Payne and Andrew Sansom
The Meadows Center for Water and the Environment,
Texas State University – San Marcos
(formerly River Systems Institute)

Table of Contents

List of Tables	4
List of Figures	4
Executive Summary	6
I. Introduction/Project Overview	14
The Vision.....	14
Summary of Project Outcomes	17
II. Review of Modeling to Determine System Requirements for Water-Independence	18
The Rainwater Harvesting Model	19
Interior Demand Rates Appropriate for RWH Systems.....	23
Summary of Right-Sized RWH Facilities.....	25
III. Governmental/Regulatory Status of Residential-scale Rainwater Harvesting for Water Supply	28
TCEQ Regulatory System.....	28
County Governmental System	29
Summary and Next Steps for Regulatory Issues.....	31
IV. Stakeholder Workshop and Consultations.....	32
Stakeholder Workshop and Consultations Goals.....	32
Venue and Format.....	32
Invitees.....	32
Agenda	32
Presentation.....	33
Results and Findings for Stakeholder Activities.....	33
Next Steps for Stakeholder Information Gathering	34
V. Review and Analysis of Backup Supply Strategies	35
Review of Backup Supply Options	35
Tanker Truck from Public Water Supply Source.....	35
Delivery from Local Wells by Water Hauling Operation.....	37
Delivery from Local Wells through a Minimal Distribution System.....	38
Obtaining Piped Water Service from a Public Water Supply System	39
Summary of Back-up Supply Options	39
Existing Water Hauling Companies Capacity and Cost of Service	40
Reviews of Existing Water Haulers	40
Viability of Backup Supply from Private Water Haulers	43
Back Up Supply Summary.....	44
VI. Hydrologic Impact of Broad-scale Rainwater Harvesting Systems in a Watershed.....	44
Modeling Parameters	45

Analysis of Roofprint Area Only	47
Project-Scale Hydrologic Analysis	48
Additional Modeling	56
Software	57
Methodology	57
Results.....	59
Summary and Conclusions for Hydrologic Impact Assessment	60
VII. Cost Effectiveness Analysis: Residential-scale Rainwater Harvesting vs. Conventional Supply	
Systems	61
Sources of Cost Information	61
Review and Discussion of System Costs	67
Summary and Conclusions for Cost Effectiveness	72
VIII. Review of Marketing Issues and Implications	74
Education is Key	74
Governmental/Regulatory Issues	76
Costs and Financing	77
Water Use, Quality and Conservation/Stewardship.....	78
Perceptions.....	79
Fire Protection and Insurance Liability.....	80
Impressions of the Market.....	80
Summary and Next Steps for Marketing Issues	82
IX. Sustainability Implications of Broad-scale Use of Residential-scale Rainwater Harvesting for Water	
Supply	83
Sustainability of Water Supplies.....	83
Impact on Sustainability of Downstream Water Supplies	86
Impact on Stormwater/Water Quality Management	87
Integrated Water Resources Management	88
X. Residential-scale Rainwater Harvesting Facility Requirements around Texas.....	89
Modeling Locations	89
“Right-Sizing” Criteria	89
Modeling Results for Standard Subdivisions	91
Modeling Results for Seniors-Only Subdivisions.....	93
Summary for Facilities around the State.....	94
XI. Subdivision-Scale Rainwater Harvesting Toolbox.....	101
Description.....	101
Audiences.....	101

Toolbox Elements	101
XII. Conclusions and Recommendations.....	102
Literature Cited.....	111
Appendix A – Rainwater Harvesting Modeling Reviews.....	112
Review of Modeling Results.....	112
Austin.....	112
Blanco.....	117
Boerne.....	121
Burnet.....	125
Dripping Springs.....	129
Fredericksburg.....	132
Menard.....	137
San Marcos.....	141
Wimberley.....	144
Appendix B – Austin Rainwater Harvesting Modeling Summary.....	149
Appendix C – Blanco Rainwater Harvesting Modeling Summary.....	154
Appendix D – Boerne Rainwater Harvesting Modeling Summary.....	159
Appendix E – Burnet Rainwater Harvesting Modeling Summary.....	164
Appendix F – Dripping Springs Rainwater Harvesting Modeling Summary.....	169
Appendix G – Fredericksburg Rainwater Harvesting Modeling Summary.....	174
Appendix H – Menard Rainwater Harvesting Modeling Summary.....	179
Appendix I – San Marcos Rainwater Harvesting Modeling Summary.....	184
Appendix J – Wimberley Rainwater Harvesting Modeling Summary.....	189
Appendix K – Forum Flier.....	194
Appendix L – Forum Agenda.....	196
Appendix M – Summary Table of RHW Sizing by Location.....	197
Appendix N – Project Scale Hydrologic Analyses Output Tables.....	199
Appendix O - Detailed Scope of Work (Submitted to TWDB).....	215
Appendix P - Findings and Recommendation Notes by Topic.....	221
Appendix Q - Modeling Process, Validation and Roof Runoff Capture.....	236

List of Tables

Table 1: Rainwater Harvesting System Water Use, History for a 4-Person Household.....	25
Table 2: Summary of Right Sized RWH Facilities by Modeling Location.....	27
Table 3: Summary of RWH Facilities for Higher Usage Scenarios by Modeling Location.....	28

Table 4: Summary of Water Hauler Information.....	44
Table 5: Hydrologic Analysis of Roofprint Area, CN = 89.	51
Table 6: Hydrologic Analysis of Roofprint Area, CN = 84.....	52
Table 7: Hydrologic Analysis of Roofprint Area, CN = 79.....	53
Table 8: Hydrologic Analysis of Roofprint Area, CN = 74.	54
Table 9: Project Scale Hydrologic Analysis, Native Site CN=89.....	56
Table 10: Project Scale Hydrologic Analysis, Native Site CN=84.....	56
Table 11: Project Scale Hydrologic Analysis I With and Without Rainwater Harvesting, Native Site CN=79.....	56
Table 12: Project Scale Hydrologic Analysis I With and Without Rainwater Harvesting, Native Site CN=74.....	57
Table 13: Project Scale Hydrologic Analysis I With and Without Rainwater Harvesting, Native Site CN=89.....	57
Table 14: Project Scale Hydrologic Analysis I With and Without Rainwater Harvesting, Native Site CN=84.....	57
Table 15: Project Scale Hydrologic Analysis II With and Without Rainwater Harvesting, Native Site CN=79.....	57
Table 16: Project Scale Hydrologic Analysis II With and Without Rainwater Harvesting, Native Site CN=74.....	57
Table 17: Project Scale Hydrologic Analysis II With and Without Rainwater Harvesting, Native Site CN=89.....	57
Table 18: Project Scale Hydrologic Analysis II With and Without Rainwater Harvesting, Native Site CN=84.....	58
Table 19: Project Scale Hydrologic Analysis III With and Without Rainwater Harvesting, Native Site CN=79.....	58
Table 20: Project Scale Hydrologic Analysis III With and Without Rainwater Harvesting, Native Site CN=74.....	58
Table 21: Project Scale Hydrologic Analysis III With and Without Rainwater Harvesting, Native Site CN=89.....	58
Table 22: Project Scale Hydrologic Analysis III With and Without Rainwater Harvesting, Native Site CN=84.....	58
Table 23: Project Scale Hydrologic Analysis IV With and Without Rainwater Harvesting, Native Site CN=79.....	58
Table 24: Project Scale Hydrologic Analysis IV With and Without Rainwater Harvesting, Native Site CN=74.....	58
Table 25: Observed Total Precipitation for the Cypress Creek/Wimberley Weather Station.....	61
Table 26: Simulated Flows in Cubic Feet per Second (CFS).....	61
Table 27: Calculated Flows for Scenarios in Cubic Feet per Second (CFS).	62
Table 28: Cost of Rainwater Harvesting System.	64
Table 29: Cost of Private Well System.....	66
Table 30: Cost of Community Well and Distribution System.	67
Table 31: Cost of Extending Service from an Existing System.....	68
Table 32: Summary and Comparison of Water Supply Options.....	75
Table 33: Backup Requirements of “Right-Sized” Rainwater Harvesting Systems in Standard Subdivisions at Modeling Locations.....	99
Table 34: Backup Requirements of “Right-Sized” Rainwater Harvesting Systems in Standard Subdivisions at Modeling Locations With Reduced Water Usage Rate.....	100
Table 35: Backup Requirements of “Right-Sized” Rainwater Harvesting Systems in Seniors-Only Subdivisions at Modeling Locations.....	101
Table 36: Backup Requirements of “Right-Sized” Rainwater Harvesting Systems in Seniors-Only Subdivisions at Modeling Locations with Reduced Water Usage Rate.....	102

List of Figures

Figure 1: Non-Integrated Water Supply System.	16
Figure 2: Integrated Water Supply System.	16
Figure 3: Rainwater Harvesting Model Input Form.	21
Figure 4: Rainwater Harvesting Model Output for Austin.	23
Figure 5: Initial Project Logo Developed.	33
Figure 6: Basins, HSPF and GenScn Results.	60
Figure 7: Cypress Creek Watershed and Subwatersheds Used in Modeling.	61
Figure 8: Interactive activity with Focus Group Participants.	76
Figure 9: Modeling Locations for Residential-scale Rainwater Harvesting System Evaluation.	93

Executive Summary

This study investigated residential-scale rainwater harvesting (RWH) systems as a water supply strategy for whole developments. It envisions collecting rainwater from building roofs and routing it to a free-standing cistern on the same lot. Each building or building cluster would incorporate a self-contained water supply system, including all facilities required to filter/treat/disinfect the water to meet all water demands within and around the building(s). All buildings may be connected to a development-wide water system through a backup supply scheme to assure a continuous water supply during drought periods. This strategy may also include arrangements for all residential-scale facilities to be maintained collectively by a management entity.

This investigation evaluated the fiscal, societal and environmental feasibility of this strategy, as well as how to properly implement and manage it to provide continuous water supply to development water users, particularly regarding its drought implications. In fact, all conventional water supply strategies comprise rainwater harvesting systems that utilize the whole watershed as the collection area, and a reservoir, aquifer or river as a “cistern.” These large-scale rainwater harvesting systems are as dependent on rainfall, and the proper sizing of the storage vessel(s), as a residential-scale RWH system. When severe drought occurs, water demands must be reduced and/or an additional supply must be accessed with either system. Examining a residential-scale RWH system entails considerations of the required facilities, the costs, the sustainability, the governance requirements, and the marketability of buildings under the conditions required to ensure a residential-scale RWH strategy as a drought-proof water supply system.

This investigation focused on the Texas Hill Country, where aquifers are under stress, and for which it would generally be very expensive to import water through regional pipelines. Thus, residential-scale RWH merits an alternative consideration. The applicability of this strategy in other areas of the state was also reviewed.

Investigation of this residential-scale RWH strategy, the results of which are discussed in the following sections, included the following elements:

- Yield-demand modeling to expose the right-sizing of RWH system water collection and storage facilities, relative to the expected building water use profile, to ensure the RWH system is sufficiently water-independent that backup water supply requirements through a period of drought would be manageable;
- Review of permitting and governance issues relative to employing a collection of residential-scale RWH systems as a development-wide water supply strategy;
- Gain input from stakeholders that may utilize, participate in the creation of, and/or benefit from this type of water supply strategy;
- Review options for, and relative merits of, a backup water supply strategy to supplement roof-harvested water during drought periods;
- Potential impact of diverting a significant quantity of roof runoff water on the hydrology of a given area, and its potential impacts on environmental flows.
- Review of the expected costs of implementing this water supply strategy, particularly the incremental building costs to be incurred to employ this strategy, vs. the costs of other water supply options.
- Review of the expected impacts of this residential-scale rainwater harvesting water supply strategy on the marketability of the serviced properties.
- Review of the expected impacts of this strategy on water resources sustainability.
- Viability of the residential-scale RWH strategy in other areas of Texas.
- Development of a ‘tool box’ of materials to disseminate the findings of this project.

YIELD-DEMAND MODELING

Yield-demand modeling is used to examine what RWH facilities are needed to attain a desired level of water independence for a residential-scale water supply system, including the quantity and frequency of backup water supply for maintaining a specific projected water usage profile. This information can be used to evaluate the feasibility and practicality of a backup water supply system required to render this residential-scale RWH strategy as drought-proof as any large-scale rainwater harvesting system comprising conventional water supply strategies. It also highlights the degree of water conservation required to be routinely practiced vs. the cost of facilities to allow a more profligate water use.

In view of the limitations of many available rainwater harvesting models using long-term average rainfall values to develop a one-year profile of the required roofprint and cistern water volume, a multi-year model is required that allows examination of system performance through wetter and drier periods. Thus, this investigation employed a historic rainfall model covering period from 1987 to 2011, being later updated to include 2012 data.

The 2008-2009 and particularly the 2010-2011 drought periods were the critical modeling periods, challenging the sustainability of the residential-scale RWH system to a greater degree than any other period. The 2010-2011 was the worst one-year drought on record over much of Texas, including the Hill Country. While the impacts of climate change are a “wild card” that might eventually alter this evaluation, it was nevertheless assumed that a residential-scale RWH system right-sized for these conditions would be right-sized for any future drought conditions.

The model evaluated the following items:

- Roofprint and cistern water volume, and most efficient combination of roofprint and cistern combination required to make the building water-independent for a presumed water use profile;
- Quantity and frequency of backup water supply incurred for a given roofprint, cistern volume and water use profile;
- Water use profile that can be supported by a given roofprint and cistern volume to attain water independence, or limit backup supply requirements;
- Impacts of an enhanced conservation curtailment rate when cistern volume drops below a preset level, illustrating the behavior effects resulting from drought contingency programs;
- Impacts of adding irrigation usage to the water demand profile, and required increased roofprint and cistern volume, and quantity and frequency of backup supply, to do so; and
- Use of reclaimed wastewater to defray irrigation usage and decrease increased roofprint and cistern volume, and/or quantity and frequency of required backup supply, to do so.

Nine locations in and around the Texas Hill Country were modeled (see Section II and Appendices A-J). An average occupancy of 2, 2.5, 3 and 4 people was assumed, each representing a subset of the housing market. Modeling also considered a range of water usage rates, including average usage, usage conditions of increasing or enhanced conservation efforts, and conditions of inefficient water efficiency. The impacts of utilizing a significant quantity of water for landscape irrigation also were modeled, with and without considering the use of wastewater generated by interior water use for irrigation supply.

For a typical 3-4 bedroom house in Hill Country locations, with a presumed average occupancy of 4 people under the critical drought periods of 2008-2009 and 2010-2011, it was found a roofprint of 4,500 ft² and a cistern volume of 35,000 gallons would generally be required to satisfy interior water demands, with manageable backup supply requirements. Little or no backup supply would have been required in other years. Locations further west would require upsized facilities. Better demand control would allow smaller facilities and/or incur less backup supply through the critical drought periods. The contrary would be true for poorer demand control, which may create capacity problems for the most likely form of backup supply; namely, trucking water to a house in a tanker truck.

Examining the floor plans of 1-story houses offered by active builders in parts of the Hill Country, an estimated 3,500 ft² of roofprint could be provided for a typical 3-4 bedroom house with a garage and covered porch/patio area. Thus, the right-sized house in this region would require addition of extra roofprint. How to most cost-effectively provide this additional roofprint, and integrate the cistern into the building design, requires further investigation.

For a seniors-oriented market with a typical nominal house population of 2 persons, the model generally indicated the right-sized facilities to be 2,500 ft² of roofprint and a 15,000-gallon cistern. It is expected a 1-story house plan with garage and modest area of covered porch/patio would provide the required roofprint.

GOVERNANCE ISSUES

Assuming it is not a public water supply system (i.e., serving 15 or more connections, or 25 or more persons, 60 days or more per year), a residential-scale RWH system serving a single house, or any other type of building or set of buildings, is essentially unregulated by any state or local

agencies. . Such systems are presently isolated and instituted unilaterally by individual building owners. If such a system were to become a water supply for an entire development, and assuming no digging of wells or piping in of water, would the regulatory status of those water supply *systems* change, and what level of governance of the water supply *system* would be imposed?

Further, for residential-scale RWH strategy to be applied universally in developments that included buildings other than single-family homes requiring a public water supply system (e.g., churches, schools, community centers, commercial centers), how to implement that water supply system to meet the rules governing it must be determined. Roof water runoff is defined as surface water by the Texas Commission on Environmental Quality (TCEQ). Because TCEQ rules require a surface water treatment system that is not affordable at the building scale, another challenge is determining what treatment system feasible to build and run at the building scale, might be approvable by the TCEQ

How the TCEQ rules might apply to the provision of a backup water supply also requires clarification. All rules applying to water hauling, and to wells and distribution systems, presume the water system in question is the *sole* water supply source to the properties being served. Thus, water system capacity and quality rules are based on the assumption that the delivered water would contribute to the *potable* water supply. It was previously noted that if residential-scale RWH systems were regulated by TCEQ, roof runoff would be classified as surface water, meaning rainwater gathered in a cistern would be deemed a non-potable water supply.

Meetings with TCEQ during this investigation included queries made to county governments about such matters, with the findings reported in Section III. The TCEQ confirmed that no state regulation would be triggered by simply putting individual residential-scale systems under the umbrella of a water supply system, as long as there was no physical interconnection of multiple systems to a common supply source, resulting in a public water supply system was generated by all the combined buildings. Based on TCEQ rules released after completion of this investigation, their impacts on an individual residential-scale system being connected to a common public water supply system were not evaluated in this investigation.

Regarding water backup supply strategies, TCEQ only specified the current rules governing water hauling and water system component sizing. These rules also were written with the express idea that such systems would provide the *only* water supply to users.

Little response was received from county governments about their platting requirements for a development proposing residential-scale RWH systems as the sole water supply. Relevant issues included whether or not to impose right-sizing of all buildings, whether or not to require an organized backup supply system run collectively for the benefit of all building owners, and whether or not to require collective arrangements for operations and maintenance of residential-scale facilities, particularly water treatment units, and/or provide organized oversight of such activities. Such actions may be deemed necessary to demonstrate water availability and assure a safe, secure water supply. Further work engaging county governments is required to consider this matter, which is important to the broadscale proliferation of a RWH water supply concept, since developers would not propose a residential-scale RWH water supply strategy if they did not know the rules required to gain approval for their development.

PRESENTATION OF CONCEPT AND SOLICITING STAKEHOLDER INPUT

In addition to direct interactions, the project team solicited stakeholder input through a Rainwater Forum involving a broad range of interests at the Ladybird Johnson Wildflower Center on February 12, 2012. The project was reviewed, the reasons why residential-scale RWH may be a valuable water supply strategy in this region were discussed, the yield-demand modeling to explain the concept of right-sizing was reviewed, and backup supply options, regulation and governance, building design issues, cost effectiveness, marketability and sustainability were discussed (see Section IV).

BACKUP WATER SUPPLY STRATEGIES

The yield-demand modeling indicated that significant upsizing of facilities and/or a high degree of water demand control would be required for complete water independence for residential-scale RWH systems during the most severe drought years. Because the facilities would be oversized for all other conditions, the cost efficient approach would be to right-size the facilities to ensure the required backup supply volume to address critical drought periods was manageable, which entails consideration of backup supply system options (see Section V).

The considered options included:

- Water delivery by tanker trucks from an acceptable water supply source, via either a private water hauler or a water supply organization serving one or more developments employing the RWH strategy;
- Water delivery in some form of portable storage (e.g., tanker truck) from wells installed in the development for the purpose of providing a backup supply;
- Water delivery via a minimal distribution pip system from wells installed in the development solely for providing backup supply. This pipe system can be sized to deliver water at the daily average use rate, rather than peak usage rate, since this flow would be replenishing the cistern volume rather than feeding directly into the house fixtures; and
- Obtaining service from a water supply entity through a water distribution system installed within the development which, as noted above, may be minimal, or fully compliant with public water supply regulations as the only water supply.

Given the tanker truck option as the means of backup supply utilized by most current rainwater harvesters is already established, at least in its basic form, and given the challenges related to implementing other options, the tanker truck option is the predominant form of backup supply service (see Section V)

IMPACT ON AREA HYDROLOGY

A repeated concern about residential-scale RWH as a water supply strategy is its potential impact on area hydrology. Withholding roof water runoff from entering streams or aquifers may reduce the available supply from those sources, upon which other users depend (see Section VI).

The conclusion is that, even if deployed at a rather high intensity, implementing residential-scale RWH systems would not result in reduced runoff flows to reservoirs or aquifers, relative to the runoff that would be generated by the land in its undeveloped condition. Based on the modeling results, impervious surfaces other than rooftops, and landform changes imparted by development, would generally result in more runoff from the developed site than would occur in the pre-development state.

Although more runoff would drain from a development if RWH were not being practiced, development is not obligated to provide an increased runoff to downstream water rights holders beyond that occurring under pre-development conditions. In fact, various storm water management practices are typically required to blunt quickflow runoff increases in order to restore a more natural balance between quickflow and baseflow. Further, the harvested rainwater does not disappear from the watershed, but is used in the buildings, with a high portion being routed back into the hydrologic cycle through wastewater systems.

COST EFFICIENCY REVIEW

The relative costs of the residential-scale RWH system vs. other water supply options are reviewed in Section VII. The RWH option was compared with a private well, a community well and a distribution system within the development, and installing a distribution system within the development connected to an existing public water supply system.

The cost analysis showed that the two collective water system options had capital costs and a net present worth or net present value (NPV) considerably below the RWH system. Their NPVs were essentially equal (a little over \$25,000 per house), but the estimated capital cost of the community well option (approximately \$11,500 per house), would be somewhat less than connecting to an existing system (approximately \$17,500 per house). The ongoing O&M costs of the community well an NPV of approximately \$14,000 per house), are higher than connecting to an existing system (a NPV of approximately \$8,000), making the overall NPV of each option essentially equal, even though each option has limited applicability.

The community well option is contingent on the presence of an aquifer under the development that can provide a sustainable water yield of water over the long term. The consequences of the well going dry would obviously be severe for the development. There may also be density restrictions imposed on developments that draw water supply from an aquifer. Aquifers in many parts of the Hill Country already being under stress at current levels of development may bode ill for supporting considerable additional development over the long term, making this option of limited applicability for serving new development over much of the Hill Country.

The option with the next lowest capital cost (estimated \$35,000 per house) is the private well. The NPV of estimated operation and maintenance (O&M) costs for this option is just under \$8,000, making the total NPV about \$43,000. The RWH option has the highest estimated capital cost (\$40,500). The NPV of the estimated O&M costs for that option are just over \$7,500, yielding a total NPV of about \$48,000. Given the caveats on all cost factors, these two options appear to be essentially comparable, with long-term operational and sustainability issues likely being a prime factor to consider.

A private well inherently restricts development intensity due to legal well spacing requirements. These requirements limit lot sizes to 6 acres or greater in at least on jurisdictions, based long-term sustainable aquifer yield considerations related to additional development. The RWH option is free from those restrictions, so the developer may be able to obtain somewhat greater lot yield under that option.

Water quality is expected to be better for the RWH option. Aquifer water underlying some of the Hill Country requires treatment to render it usable for domestic supply. In contrast, the quality of roof-harvested rainwater is typically very good, needing only rather minimal treatment to assure

its potable use. The O&M effort and expense for a well water treatment system would be somewhat greater than for an RWH system, if the well water required softening to be rendered usable for domestic supply.

Thus, while raw cost comparisons do not favor the RWH option, the circumstances of each development may heavily influence the most desirable option. While the collective options exhibit lower overall costs, they also would require a significant upfront financial commitment in constructing the first house, while the RWH option (and private well option) can be installed as each house is built, precluding this upfront investment. Given the condition of the aquifers presently providing water supply in the Hill Country, the RWH may prove to be the overall most feasible option for new developments over much of the area.

MARKETABILITY ISSUES AND OPPORTUNITIES

To help evaluate the marketability of developments that would employ the residential-scale RWH strategy, a focus group was convened on August 15, 2012, representing numerous stakeholders, including land developers, homebuilders, architects, land planners and engineers, real estate brokers, a home finance banker, and consumers (potential home buyers). The focus group was convened on August 15, 2012 (see Section VIII).

That education is a key to all aspects of marketability was a theme of the discussions, including:

- Education of developers about the availability of this concept, its potential merits, and how to navigate a development interested in this water supply strategy through the planning and regulatory processes;
- The need to obtain clarity in regulatory and planning processes, entailing education of the various regulatory jurisdictions about the nature and capabilities of this concept;
- Education of land planners and engineers advising developers, and which have the responsibility for properly designing the systems;
- Education of architects and homebuilders, particularly about right-sizing buildings, and opportunities for more cost-efficiently incorporating right-sized facilities in building designs;
- Education of the lending sector on the viability of RWH, and the value added to a house to offset RWH facility costs;
- Education of potential buyers on the nature of residential-scale RWH systems, on the concept of right-sizing and implications for water use; and
- Education of all the stakeholders about the general water environment and future regional water prospects, and how the RWH option may insulate its users from future rate shocks.

SUSTAINABILITY ISSUES

The impact of the residential-scale RWH water supply concept on sustainability (see Section IX) would encompass the following aspects:

- This strategy would reduce stress on conventional water supplies, particularly local groundwater, with its sustainable use being at issue over much of the Texas Hill Country;
- The sequestration of roof runoff in rainwater cisterns may impact the quantity of runoff entering downstream, and thereby the sustainability of water supplies depending on streamflow (see Section VI);

- Sequestration of roof runoff in rainwater cisterns may positively affect stormwater management, since it impacts both water quality and the need for detention to prevent increased downstream flooding inducible by development.

Considered together, these factors indicate residential-scale RWH is a component of integrated water management. This concept assumes all water resources exist within a closed loop – the hydrologic cycle – and that water systems should be considered integrated systems in order to maximize human water use efficiency, with the infrastructure addressing each function being designed as an integrated component of an overall system. Water supply, stormwater management and wastewater management are all facets of an overall integrated system, which contrasts with conventional non-integrated water management practices that focus on each water management function isolated from the other functions. Key to this integration is decentralization of the management facilities, with the highly distributed water supply function, as offered by the residential-scale RWH system, being a key component.

VIABILITY OF RAINWATER HARVESTING CONCEPT IN OTHER AREAS OF TEXAS

The potential application of the residential-scale RWH water supply concept in other parts of Texas also was reviewed in this investigation. Twenty-three additional locations covering about the eastern two-thirds of Texas were modeled to determine the right house size for both a general market (nominal 4-person occupancy) and a seniors market (nominal 2-person occupancy) at each location offering a view of the cost-effectiveness of this strategy (see Section X).

Observing the critical 2008-2009 and 2010-2011 drought periods, a truncated model covering the period of 2007-2012 was used to reduce the data required for the expanded range of examination. The nine original Hill Country locations also were re-modeled, with these results being reported along with the 23 new locations.

This concept would generally be more viable, as measured by the right-size (i.e., cost of roofprint and cistern), in east and north areas of the Hill Country, and would on about equal footing as the original nine Hill Country locations in all other areas, except for Lubbock, Laredo and the Lower Rio Grande Valley. Considerably larger facilities would be required to right-size the RWH systems in these latter locations.

THE TOOL BOX

The results this investigation on rainwater harvesting as a water supply strategy for Central Texas and Hill Country developments is of value to numerous groups, including developers, land planners, engineers, architects, builders, the banking, mortgage and financial community, the real estate community, and the public sector, including municipal and county planning departments and regulatory agencies.

Key information and outcomes from this Rainwater Harvesting investigation at the subdivision-wide scale was compiled to share and disseminate project results and findings to these audiences. This resulting tool box, containing a project executive summary, draft press release, study fact guide, summary video and webinar, the modeling tool used for project activities, and a resource guide, is available on the website (txhillcountrywater.org), and through the TWDB.



I. Introduction/Project Overview

The Vision

Residential-scale rainwater harvesting (RWH) systems, integrated with a backup supply system, were investigated as a water supply strategy for whole developments. This strategy envisions collecting rainwater from building roofs and routing this water to a cistern, perhaps integrated into the structure of each building but certainly associated with that building – e.g., a free-standing cistern on the same lot. Each building – or for a commercial center or housing on a condo lot, perhaps a cluster of buildings – would incorporate a self-contained water supply system, including all facilities required to filter/treat/disinfect the water enabling supply for all water demands – including potable – within and around the building(s). However, all buildings may be connected to a development-wide water system through a backup supply scheme. This strategy may also include arrangements for all residential-scale facilities to be maintained collectively by a management entity.

Residential-scale rainwater harvesting is one of a limited number of options for suburban and rural areas where intensive future development is expected. Other water supply options include private wells, community wells and small-area distribution systems, high-producing wells and large-area distribution systems, and importing water from reservoirs or remote aquifers in regional scale water transmission mains. It is important to understand that these too are all rainwater harvesting systems. They use entire watersheds as the collection area and aquifers and reservoirs as the “cisterns”. This reveals the intuitive nature of harvesting rainwater. It differs from the normal water supply systems only in the complexity and scale of the precipitation and water usage link.

The findings and recommendations in “Rainwater Harvesting Potential and Guidelines for Texas,” a report to the 80th Texas Legislature subsequent to the charge issued in HB 2430, make it clear that a rainwater harvesting water supply strategy is a valid and pertinent strategy in Texas. This study proposes to examine residential-scale rainwater harvesting as the water supply strategy in the context of rural and suburban areas slated for development, with emphasis on areas drawing water from the Edwards, Trinity and other aquifers which are being stressed in the Texas Hill Country.

This water supply strategy is envisioned as part of an integrated water resources management system. Our water resources exist within a closed system – called the hydrologic cycle – but traditional approaches used in residential and commercial developments “silo” the management of each of those functions into totally separate systems – water supply, stormwater, and wastewater. If we are to maximize efficiency and effectiveness of water use, thus maximizing the sustainability of water resources, our management strategies must recognize that *all* water exists in the context of its system. We must, therefore, design management approaches in accord with that understanding – as an *integrated systems*, with infrastructure that addresses each function being designed as an integrated component of an overall system. Figures 1 and 2 below

compare a non-integrated or “silo’d” system with an integrated management system, illustrating how rainwater harvesting might be integrated into the overall water resources management system. This shows how efficient use of the water resource may be enhanced by “tightening” water loops, using strategies such as residential-scale rainwater harvesting. It also illustrates how point-of-use wastewater reuse can reduce demands on the original water source, a factor that will prove *very* valuable for a building using rainwater harvesting as its original supply source.

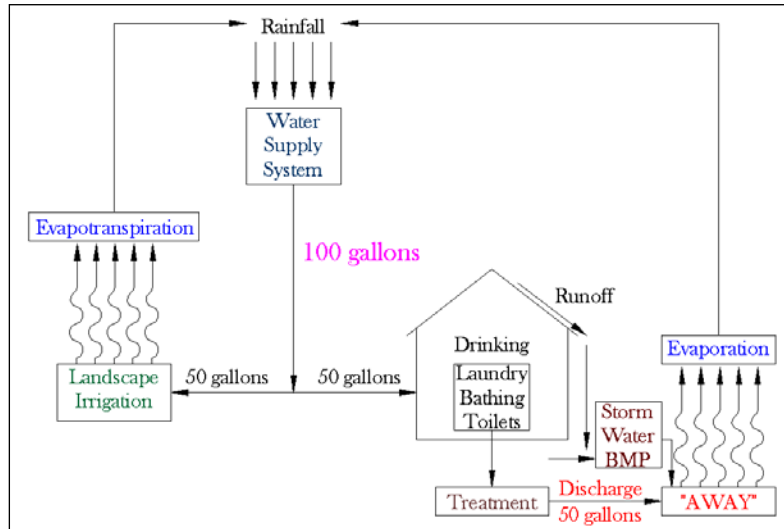

Figure 1: Non-Integrated Water Supply System.

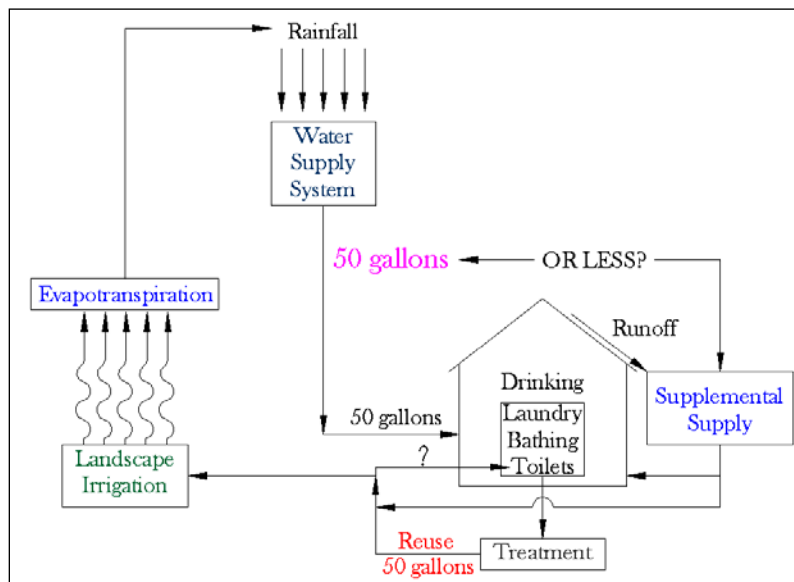

Figure 2: Integrated Water Supply System.

The immediately obvious question about rainwater harvesting as a water supply strategy is, what happens in a drought? The residential-scale rainwater harvesting system can be made as immune to loss of supply as any other system by providing an assured (guaranteed) backup supply system. As noted, this organized backup supply might be considered the connection to a development-wide water supply system. The major issue is how practical and cost efficient those provisions may be in any given context vs. simply connecting to one of those larger-scale water supply systems. Setting up that backup supply system would require organization,

possibly some permitting, and management. Defining these needs is a central focus of the proposed investigation.

A major reason to favor residential-scale rainwater harvesting in the Edwards and Trinity areas is to limit routine, everyday withdrawals from the aquifers, helping to extend those supplies in a drought. Some other reasons to expect that a residential-scale rainwater harvesting strategy may provide a more fiscally reasonable, more societally responsible, and a more environmentally benign water supply strategy than the other options – especially a sprawl-inducing regional pipeline – include:

- While the initial cost per gallon incurred may be higher, the residential-scale rainwater harvesting facilities are relatively small incremental investments that require only the expenditure of resources needed to serve development actually being installed, freeing considerable resources for alternate investments. Since up-front costs are minimized, the short-term cost efficiency for the developer may be compelling.
- Over the long term, the time value of money may also favor a pay-as-you-go strategy. The large-scale infrastructure is an all-or-none decision requiring a very large investment well in advance of *any* delivery of service, financing large-scale facilities that would not be fully utilized for many years. All users of this system would be paying the cost of these unused facilities throughout that period.
- Given the rural location of the projects combined with uncertainty about future transport fuel costs, *and* given the uncertainty about the real estate market generally, if build-out does not proceed as contemplated, the developer and/or system users would be left to pay back a large up-front investment with short revenues, perhaps drastically increasing water rates or taxes for the customer base. The larger scale the system, the bigger the gamble.
- The cost and timing of the large-scale infrastructure installation, requiring planning and coordination by multiple jurisdictions and agencies, is typically out of the developer's (and the eventual users') control, as would be the cost of water obtained from that system. The cost and timing of the residential-scale facilities are entirely within the users' control, and the on-going cost of water would be low *and* would not be prone to escalation.
- In the large-scale system, treatment problems, line breaks, etc., would have broad ranging impacts, with unpredictable costs to the users. In the residential-scale system, any problems would be isolated and amenable to remediation by individual users and/or the local operating entity. Thus, from a certain viewpoint, the residential-scale system is *more* reliable than a large-scale system.
- Residential-scale rainwater harvesting is an inherently more sustainable strategy in terms of water resources management than other options, since the development would, in large measure, live on the water that falls upon it. Needing to do this engenders a conservation ethic and stimulates pursuit of efficiency strategies, which may not appear cost efficient—and thus may be hinder—once there is a large sunk cost in a piped water system. Enhancing efficiency would enhance water supply sustainability generally.
- The water supply from a residential-scale rainwater harvesting system may be of higher quality than would be obtained through a piped water system. Rainwater is soft and

generally high in quality. In large-scale systems, there is little control over the collection area, so stored water is of random quality, with the inclusion of whatever pesticides, fertilizers, and other pollutants are contributed by overland flow, requiring considerable treatment to attain potable quality.

- A large-scale treatment system and a wide spread distribution system entail considerable demand for increasingly expensive energy. A point of use treatment and pressurization system would demand far less energy, and would thus entail considerably lower operating cost and be more sustainable.

The confluence of such fiscal, societal and environmental pluses for residential-scale rainwater harvesting urges the consideration of this strategy to serve as a development-wide water supply system. This project is an investigation to evaluate that strategy – fiscally, societally and environmentally – and to provide guidance for how to implement and properly govern such a strategy so that it would provide a continuously-assured water supply to users of the development, thus rendering this strategy as reliable as any of the other water supply options.

Summary of Project Outcomes

The intended outcomes of this project are reviewed below.

- **Conduct a modeling process, showing the roofprint and cistern volume requirements** relative to presumptions of water demand to be served and the frequency of backup supply that these choices would impose. These results define the infrastructure requirements of the system. The model covers the 25-year period from 1987 thru 2011. That period includes several droughts of varying severity, with the 2008-2009 and 2010-2011 periods being the most severe. The model can consider both interior and irrigation demands, and also how the demand for irrigation directly by harvested rainwater would be modified if interior uses were routed through a wastewater system to defray those irrigation demands. This shows how very valuable point-of-use reuse would be to a rainwater harvester. The initial modeling was conducted for nine locations in the Texas Hill Country, the primary focus of this project. The modeling process is reviewed in Section II (results are displayed in the appendices).
- **Review of the expected permitting and governance issues entailed in using this strategy** as a development-wide system, including consideration of the regulatory status of rainwater harvesting for potable water supply. This was considered, to the extent possible by meeting with and/or querying TCEQ and local regulatory personnel, soliciting from them the permitting and governance requirements that would likely be imposed upon a development that proposed to pursue this water supply strategy. In particular, it must be determined how TCEQ would regulate rainwater harvesting if used in a situation where the building or campus scale system would be classified as a public water supply system, for example in a village center of a development. Investigations into governance issues are reviewed in Section III of this report.
- **Gaining input of a variety of stakeholders which may utilize, participate in the creation of and/or benefit from this type of water supply strategy.** Stakeholder input and participation was solicited through seminars, workshops and meetings held throughout the project. These activities are reviewed in Section IV of this report.

- **Review of options for a backup supply system.** This entailed discussions with existing water haulers to gain insight into capacity already available and how they might participate in a backup supply system. Shortfalls in capacity were identified and options to fill that gap were considered. This aspect of this water supply strategy is discussed in Section V of this report.
- **Examination of the potential impact of a significant flow of roof runoff being diverted into cisterns rather than contributing to environmental flows,** thus impacting on the local hydrology. Hydrologic modeling was used to investigate findings within undeveloped and developed areas with and without RWH applied. The findings of this investigation are reviewed in Section VI of this report.
- **Review of the expected costs of implementing this water supply strategy,** in particular the incremental costs of buildings that would be incurred to employ this strategy, and of the savings on a traditional water supply that might offset those costs. These costs and opportunities were derived by soliciting input from engineers, architects, builders, and developers, to the extent possible. Some of this input was gained through the stakeholder seminar, with gaps filled in by one-on-one interaction with the various sources of expertise. The cost implications of this water supply strategy are reviewed in Section VII of this report.
- **Review of expected impacts of using the residential-scale rainwater harvesting water supply strategy on the marketability** of properties and subdivision scale RWH systems. Perspectives on marketability were obtained by querying existing rainwater harvesters about why they chose that water supply system and by discussions with builders and developers and a wide variety of other stakeholders. Marketability implications are discussed in Section VIII of this report.
- **Review of the expected impacts of using this strategy on the sustainability of water resources,** with emphasis on the Edwards and Trinity aquifers. This included a consideration of the hydrologic impacts from a sustainability perspective, but the main focus of this review was on the demand of stressed aquifers that this strategy could relieve. A review was compiled to assess the potential ability of this strategy to minimize stress to aquifers during drought conditions, or at least dictate that they would not become significantly stressed until a drought had lingered for a longer period of time. These dimensions of this water supply strategy are discussed in in Section IX of this report.
- An expansion of the modeling to cover areas of Texas outside the Hill Country, to show the relative feasibility of this water supply strategy for an additional 23 locations over much of Texas. These results are presented in Section X of this report.
- A “tool box” to share and disseminate the results and findings of this project was created. A summary of the tool box components is included in Section XI of this report. The tool box will be provided to the TWDB and upon approval will be available at txhillcountrywater.org.

II. Review of Modeling to Determine System Requirements for Water-Independence

Under the water supply strategy being investigated in this project, all buildings may be connected through a backup supply scheme, so that water supply could be assured through a

prolonged drought. It is important to assure that the RWH systems serving each of the buildings are right-sized to supply the level of demand expected in each building, so that any backup supply strategy would be manageable in terms of volume of that supply and system logistics. This section reviews the modeling process conducted to determine the “right-sizing” of those facilities.

As will be reviewed in Section V, backup supply is most likely to be provided by water hauling, and the capacity of such a backup supply system would be subject to a number of factors. So it is not practical to definitely state the amount to which backup supply would have to be limited in order to render that system manageable in every context. In general, due to the capacity limitations reviewed in Section V, a system would be considered right-sized if no more than one truckload of backup water supply would be required in any one calendar month.

A rainwater harvesting model has been developed to determine this right-size for each building-scale RWH system, given the level of water demand expected to be incurred by the occupants of that building. This section reviews that model and the results of the modeling process for single-family homes, conducted for nine locations in the primary focus area of this project, the area in and around the Texas Hill Country, where aquifers are under stress and it would generally be very expensive to import water through regional pipelines.

While the basic building-scale RWH strategy could be applied to any type of building, the water demand profile would be dependent on the usage of the building. The expected water demand profile of any type of building but a residence may not be known a priori, and thus each situation would have to be modeled individually in order to determine the required footprint and cistern volume. This modeling review focuses only on residences, understanding that this sort of modeling may be done for any type of building, given the water demand profile expected in that building.

The Rainwater Harvesting Model

Most efforts to determine the right size of rainwater harvesting system components employ a model using average rainfall for the location being evaluated. That approach is limited and does not explicitly show how often backup supply would be needed. This project employs a historic rainfall model, developed by the lead author, utilizing rainfall data over a period of years from local weather stations to evaluate the performance of a given system configuration over those years, through varying cycles of high and low rainfall. This model covers the 25-year period from 1987 through 2011.

The model uses monthly calculation steps. It was evaluated against a similar model employing daily calculations steps, and it was found that the monthly model produces very similar profiles of backup water supply requirements, the critical piece of information provided by the modeling process. Model inputs are footprint (collection area), cistern volume, daily water use, interior and/or exterior (irrigation). The model calculates the volume of water that ran into the cistern and deducts the water used in each month to calculate the end-of-month volume in the cistern, the amount of water that overflowed the cistern or the amount of backup water supply that had to be added to the cistern to provide the water used in that month. (It is presumed as a uniform starting point that the cistern is half-full at the beginning of the modeling period.) Backup supply is presumed to be delivered by a 2,000-gallon tanker truck, so it will always be a multiple of that amount. A copy of the data input page, on the 1987 model, is shown in Figure 3, illustrating the

inputs and also the model results for that year, given those inputs. The shaded boxes highlight the inputs which the model accommodates.

Austin

Monthly Rainwater Harvesting Model - 1987

Shaded boxes are user inputs

Copyright 2011
David Venhuizen, P.E.

System Sizing Parameters			Interior Demand							
Collection area =	4,500	sq. ft.	Occupancy =	4	persons					
Total storage =	35,000	gallons	Usage rate =	50	gpcd					
Cistern alarm level:	0	gallons	(Cistern volume at which enhanced conservation is practiced -- input zero to disable this fun			Wastewater irrigation		0	(1= yes, 0= no)	
Enhanced conservation curtailment r	1	(Input 1.0 to curtail irrigation only)			Irrigated area =		0	(Input zero to disable irrigation model)		
(Reduces interior demand to this rate times usage rate)										

	Daily Demand in Each Month		No. of Days		Irrigation Rate	Irrigation Demand
January	200	gpd	31		0.00	0 gpd
February	200	gpd	28		0.00	0 gpd
March	200	gpd	31		0.20	0 gpd
April	200	gpd	30		0.50	0 gpd
May	200	gpd	31		0.75	0 gpd
June	200	gpd	30		1.00	0 gpd
July	200	gpd	31		1.00	0 gpd
August	200	gpd	31		1.00	0 gpd
September	200	gpd	30		0.75	0 gpd
October	200	gpd	31		0.50	0 gpd
November	200	gpd	30		0.20	0 gpd
December	200	gpd	31		0.00	0 gpd

Month	Austin rainfall (inches)	Gallons collected per sf.	Total supply (gal.)	Total demand (gal.)	Net change in storage (gal.)	Total gal. in storage	Overflow (gal.)	Total Overflow (gal.)	Make-up water (gal.)	Total Make-up (gal.)	
Initial storage assumed =						17500					
January	1.09	0.654	2898	6,200	-3302	14198	0	0	0	0	
February	2.84	1.704	7623	5,600	2023	16221	0	0	0	0	
March	1.09	0.654	2898	6,200	-3302	12919	0	0	0	0	
April	0.45	0.270	1170	6,000	-4830	8089	0	0	0	0	
May	6.74	4.044	18153	6,200	11953	20042	0	0	0	0	
June	10.85	6.510	29250	6,000	23250	35000	8292	8292	0	0	
July	3.46	2.076	9297	6,200	3097	35000	3097	11389	0	0	
August	0.24	0.144	603	6,200	-5597	29403	0	11389	0	0	
September	4.65	2.790	12510	6,000	6510	35000	913	12302	0	0	
October	0.31	0.186	792	6,200	-5408	29592	0	12302	0	0	
November	2.76	1.656	7407	6,000	1407	30999	0	12302	0	0	
December	1.22	0.732	3249	6,200	-2951	28048	0	12302	0	0	
TOTALS	35.70	21.420	95,850								

Total annual demand =	73,000
Demand met by rainwater =	73,000
% demand met by rainwater =	100.0%
% of total demand wasted =	16.9%
% of total supply wasted =	12.8%

Figure 3: Rainwater Harvesting Model Input Form.

Interior water use is modeled by inputting an occupancy and usage rate per occupant. Regarding residential water usage rates, it is noted that a conventional water supply system design presumes standard demand rates which are typically very liberal estimates of what actual water use may be. However, when considering a rainwater harvesting strategy, an opposite viewpoint is urged, as it is critical for cost efficiency to determine how *low* of a usage rate may be adequate. The range of interior demand rates deemed appropriate to consider are reviewed below.

Exterior (irrigation) water use is modeled by inputting an irrigation profile as the inches per week to be applied in each month to the landscape being irrigated. It is presumed that two thirds of the rainfall received in each month is effective in satisfying irrigation demand, and the rest must be provided out of the rainwater cistern. The irrigation profile used for all model runs in this modeling process is shown in Figure 3.

The model also allows evaluation of the impact of reusing wastewater flowing from the building to defray irrigation demands. This would allow the hard-won rainwater to be used twice, once in the building and again for irrigation. Many, perhaps most, of the developments that may utilize this water supply strategy would manage wastewater in individual (or small-scale cluster) on-site septic systems. Those systems can be designed to incorporate a pretreatment system and to route the effluent from that system to a subsurface drip irrigation field. This field can be arrayed to irrigate the highest value landscaping that would be irrigated in any case (presuming the building occupants wish to maintain such an improved landscape). When this option is employed, the model presumes that 90% of the interior water use appears as wastewater flow, and that drip irrigation is 90% efficient at delivering water to the plants.

An enhanced conservation curtailment rate can also be specified, along with a cistern alarm level at which that rate would be applied. Whenever the cistern volume drops below the alarm level, interior use is reduced to the modeled demand rate times the curtailment rate, and all irrigation with rainwater directly from the cistern is stopped. (If being modeled, irrigation from wastewater reuse would continue unabated.)

Conservation programs, or more correctly drought contingency programs, of local water providers urge, and some even dictate, such curtailment of water demand when certain trigger conditions are encountered. Users of a rainwater harvesting system have a very explicit motivation for adhering to such curtailments— the dwindling supply in the cistern and the prospect of needing a relatively expensive backup supply. This feature of the model allows explicit evaluation of the impact of such curtailment on the residential-scale RWH system.

The amount of water collected is presumed to be 0.6 gallons per inch of rainfall per square foot of roofprint minus a commonly recommended first-flush diversion rate of 1 gallon per 100 square feet of roofprint. The theoretical maximum runoff is 0.623 gal/in/ft². The losses presumed and the validity of this capture rate are reviewed in Appendix Q.

The model output is illustrated in Figure 4. The inputs for the model run producing this output are shown at the top and a summary of the results in each year covered by the model are listed below that. These include the total rainfall, the gallons of backup supply required, the percent of total demand provided by the building's RWH system, the total amount of water that overflowed because the cistern was full, and the percent of the total roof runoff that was lost to overflow. This is followed by yearly summaries listing the total amount of backup supply required over the model period, the maximum amount of backup supply required in any one year, and the number of years in which backup supply would have been required. Finally, a list of the total and largest amount of water lost to overflow in any one year is provided.

Monthly Rainwater Harvesting Model - 25-Year Summary

System Sizing Parameters			Interior Demand			Copyright 2011 David Venhuizen, P.E.														
Collection area =	4,500	sq. ft.	Occupancy =	4	persons															
Total storage =	35,000	gallons	Usage rate =	50	gpcd															
Cistern alarm level:	-	gallons	Irrigated area =			0	sq. ft.													
Enhanced conservation curtailment r:	1		'Wastewater irrigated'			0	(1= yes, 0= no)													
Interior Daily Demand in Each Month			No. of Days		Irrigation Rate															
January	200	gpd	31		0.00	in/week														
February	200	gpd	28		0.00	in/week														
March	200	gpd	31		0.20	in/week														
April	200	gpd	30		0.50	in/week														
May	200	gpd	31		0.75	in/week														
June	200	gpd	30		1.00	in/week														
July	200	gpd	31		1.00	in/week														
August	200	gpd	31		1.00	in/week														
September	200	gpd	30		0.75	in/week														
October	200	gpd	31		0.50	in/week														
November	200	gpd	30		0.20	in/week														
December	200	gpd	31		0.00	in/week														
Parameter	1987	1988	1989	1990	1991	1992	1993	1994	1995	1996	1997	1998								
Total rainfall - inches	35.70	19.21	25.87	28.44	52.21	46.05	26.50	41.16	33.98	29.81	46.79	39.12								
Total makeup demand - gallons	0	0	0	2,000	0	0	0	2,000	0	0	0	0								
Demand provided by rainwater	100%	100%	100%	97%	100%	100%	100%	97%	100%	100%	100%	100%								
Total overflow (lost supply) - gallons	12,302	0	0	0	40,159	51,701	18,719	17,822	23,074	2,211	52,461	34,117								
Portion of rainfall lost	13%	0%	0%	0%	29%	42%	26%	16%	25%	3%	42%	32%								
Parameter	1999	2000	2001	2002	2003	2004	2005	2006	2007	2008	2009	2010	2011							
Total rainfall - inches	20.87	37.27	42.87	36.00	21.41	52.27	22.31	34.70	50.41	16.58	38.65	30.69	10.29							
Total makeup demand - gallons	0	0	0	0	0	0	0	0	0	4,000	8,000	0	22,000							
Demand provided by rainwater	100%	100%	100%	100%	100%	100%	100%	100%	100%	95%	89%	100%	64%							
Total overflow (lost supply) - gallons	936	6,729	42,209	23,660	3,122	53,888	109	3,030	70,902	0	4,060	23,187	0							
Portion of rainfall lost	2%	7%	37%	24%	5%	38%	0%	3%	52%	0%	4%	28%	0%							
Total makeup demand over 20-year period =	38,000		gallons																	
Maximum makeup required in any one year =	22,000		gallons																	
Number of years in which makeup was required =	5																			
Total overflow lost over 20-year period =	484,398		gallons																	
Maximum overflow lost in any one year =	70,902		gallons																	

Figure 4: Rainwater Harvesting Model Output for Austin.

Presuming that future rainfall patterns would not markedly depart from those experienced in the historical period it covers, this model offers an expectation of how much, and how frequently, backup supply might be required in the future, given the roofprint, cistern volume and water use profile that was input. That enables one to choose the most cost efficient design for the overall water supply system, considering the costs and operational issues of the backup system, and to set the water usage rates that must be achieved to deliver the desired overall system performance.

To summarize, the model can be used to evaluate:

- roofprint and cistern volume required to make the building water-independent for a presumed water use profile, and the most efficient combination of roofprint and cistern to do so;
- amount and frequency of backup water supply incurred, given a roofprint, cistern volume and water use profile, and the most efficient combination of roofprint and cistern for this case;
- the water use profile that can be supported by a given roofprint and cistern volume to attain water independence, or to limit backup supply requirements to a desired standard;
- the impact of an enhanced conservation curtailment rate when cistern volume drops below a preset level, showing the effect of behavior urged by drought contingency programs;
- the impact of adding irrigation usage to the water usage profile, showing required increase in roofprint and cistern volume to support this and/or the amount and frequency of backup supply this usage would require; and

- how using reclaimed wastewater to defray irrigation usage can blunt that increase in required roofprint and cistern volume and/or the amount and frequency of backup supply required.

Additional information about the modeling process, validation and roof runoff capture rates is provided in Appendix Q.

Interior Demand Rates Appropriate for RWH Systems

It is often asserted that the standard demand rate for design of water supply systems is 100 gallons per capita per day (GPCD). That amount is, however, quite excessive for residential *interior* water usage by most people. The presumed water usage rate in the Texas on-site wastewater code (30 TAC Chapter 285) is 75 GPCD when non-conserving fixtures are installed in the house and 60 GPCD with conserving water fixtures. Since only the fixtures presumed to be conserving can be purchased in Texas now, 60 GPCD is used for all new houses. Even this rate is understood to be generally excessive, as many studies have shown that water usage rates in houses served by on-site wastewater systems are 50 GPCD or less, but 60 GPCD is presumed for conservatism and to help assure that the wastewater system design accommodates outliers, those who may be more liberal in their water use.

Those who employ rainwater harvesting for their water supply typically understand the need to be reasonably conservative in their water use, as they can readily see their supply dwindling when rainfall becomes scarce, as it periodically does in Central Texas. Therefore it is reasonable to presume that a 50 GPCD demand rate is a default that would not significantly restrict lifestyle. It remains to be examined how far below that is compatible with a lifestyle that does not leave the RWH system users feeling deprived.

It is reported that those who plan RWH systems typically presume a demand rate of 35 GPCD. It may be called to question if that is reasonable to expect. A case study is instructive in that regard. One rainwater system user has kept meticulous records for the last 9 years, measuring rainfall, recording cistern levels, and – most importantly – metering water flow out of the cistern. The house was occupied by a family of four – husband, wife, one son and one daughter. The daughter was 10 and the son was 7 in 2003, when the water meter was installed and this RWH user began to record usage, and they are now 18 and 15. The 18-year-old daughter left for college in August of 2011, so the 4-person occupancy was maintained throughout almost the entire 9-year period. This RWH user reported that no landscape irrigation was practiced. He also reported that the house is fitted with current standard fixtures, a front-loading washing machine – installed in 2005 – being the only one that may be considered a high conserving fixture, indicating there were no extraordinary efforts to conserve water in terms of the hardware employed. The average daily total water usage and the average daily usage per person over that period are shown in Table 1.

Rainwater Harvesting System Water Use History 4-Person Household, 2 Adults, 2 Children			
Year	Total Water Use (gallons)	Average Daily Water Use (gpd)	Average Daily Water User per Person (gpcd)
2003	32,457	88.9	22.2
2004	34,361	93.9	23.5
2005	33,840	92.7	23.2
2006	32,007	87.7	21.9
2007	35,529	97.3	24.3
2008	34,482	94.2	23.6
2009	38,544	105.6	26.4 ²³
2010	41,118	112.7	28.2
2011	36,174	99.1	24.8
9-year avg.	35,390	96.9	24.2

Table 1: Rainwater Harvesting System Water Use, History for a 4-Person Household.

The overall average usage for 2011 calculates to be 99.1 gallons per day (GPD), and this RWH user calculated from interim meter readings that usage averaged 92 GPD since his daughter left for college. This indicates that the demand rate for 3-person occupancy over this period was approximately 30.7 gallons per capita per day (GPCD), as compared to the full year average of 24.7 GPCD presuming 4-person occupancy. This is to be expected, as water use for such functions as dishwashing, laundry and housecleaning would not likely scale directly with occupancy.

Notably, this RWH system user feels that he and his family live a fairly normal lifestyle, though possibly more attentive to water use than most, paying very close attention to leak control, etc., due to their dependence on rainwater.

This highlights the importance of a conservation ethic to the cost efficient practice of rainwater harvesting as a water supply strategy. The information in Table 1 indicates, given such level of care, that a demand rate of 35 GPCD may actually be somewhat liberal for interior water usage. It may be questioned, however, if a more general population would be able and willing to practice water conservation at the level this family does.

Table 1 shows that average usage rate did increase as the children moved into their teenage years. This can likely be explained by two circumstances. One, the husband began working out of a home office during 2008. Two, the daughter participated in athletics, generating additional laundry. Despite this, the average usage rate after 2008 remained below 30 GPCD.

Lest one believes that this family is an outlier, the lead author's own experience offers another case in point. Winter water use in his home routinely runs, per the water bill, at 2,200 gallons/month. This is a 2-person household, where both individuals work out of home offices and are generally in residence throughout the day. The house is fitted with typical current state-of-the-art fixtures, the only one of which might be considered atypically conservative being a front-loading washing machine. 2,200 gallons/month yields an average usage rate of about 37 GPCD. This is in a house connected to a public water supply, where there is no compelling reason to be ultra-conservative. This would indicate that indeed ~35 GPCD interior water use may be rather routinely attainable while maintaining a normal lifestyle.

Considering this information, the default interior water usage rate used in the modeling is 50 GPCD. This is expected to be a level readily attainable without major curtailment of use for most people, so is employed as the default rate because rainwater harvesting is being investigated as a *broadscale* strategy, suitable for a wide range of the population. Demand rates of 45 GPCD and 40 GPCD are also explicitly evaluated to demonstrate the impact of demand control on required sizes of the roofprint and cistern relative to requirements for backup water supply, and thus on the cost efficiency of RWH systems. It is noted again that even 40 GPCD

appears to be readily attainable by much of the population. Using the enhanced conservation curtailment rate, scenarios in which water use is reduced down to 35 GPCD when the water level in the cistern drops to the alarm level are also evaluated. Understanding that there is a population that will maintain more liberal water use habits, and to illustrate the impact on system sizing of failing to exercise demand control, a demand rate of 60 GPCD is also modeled.

Summary of Right-Sized RWH Facilities

As noted previously, the most critical piece of information to be derived from the modeling is the right size of the RWH system roofprint and cistern for each situation. Summarized in Table 2 for each modeling location are the smallest RWH system roofprint and cistern capacity which, based on the modeling results, are considered to be right-sized, listed for the 2-person, 3-person and 4-person occupancy scenarios. These are the system configurations that are proposed to be used to generate cost estimates for the residential-scale RWH systems, an input to the evaluation of the cost effectiveness of this water supply strategy.

Also shown in Table 2 is the level of demand control indicated by the modeling results that must be maintained, *in the critical drought years only*, for the listed configuration to have incurred a marginally manageable or manageable level of backup supply. In cases where the demand must be controlled below the default usage rate of 50 GPCD, a larger configuration could have been listed which would have required a lesser level of demand control. The overviews of the modeling results for each of the locations can be reviewed to gain an appreciation for the potential limitations of the configurations listed in Table 2.

It is noted again that the critical conditions are expected to be incurred only at multiple-year intervals. This is borne out by the modeling results, which show that, presuming the RWH system configurations listed in Table 2, backup supplies would have been required in only the most critical drought periods covered by the 25-year modeling period. If backup supply requirements were meant to intermittently manage a tanker truck backup supply system, arrangements could be made to cover such events. Understanding this, the minimum configurations listed in Table 2 are deemed to be appropriate, noting however that some predictions indicate the prospects for long-term drought conditions in this region. It may therefore be deemed prudent to install more conservative (larger) RWH system configurations to ensure that manageability is not stretched too far and/or too often. These are matters to be taken into account when setting public policy to guide or govern this residential-scale rainwater harvesting water supply strategy.

Table 2: Summary of Right Sized RWH Facilities by Modeling Location.

SUMMARY OF "RIGHT-SIZED" RWH FACILITIES AT EACH MODELING LOCATION									
Modeling Location	2-Person Occupancy			3-Person Occupancy			4-Person Occupancy		
	Roofprint (sq. ft.)	Cistern Size (gallons)	Usage must be controlled to*	Roofprint (sq. ft.)	Cistern Size (gallons)	Usage must be controlled to*	Roofprint (sq. ft.)	Cistern Size (gallons)	Usage must be controlled to*
Austin	2,500	15,000	40 gpcd	4,000	25,000	45 gpcd	4,500	35,000	40 gpcd
Blanco	2,500	15,000	45 gpcd	4,000	20,000	45 gpcd	4,500	35,000	40 gpcd
Boerne	2,500	15,000	45 gpcd	4,000	20,000	45 gpcd	4,500	35,000	40 gpcd
Bumet	2,500	15,000	N/A	4,000	20,000	45 gpcd	4,500	30,000	45 gpcd
Dripping Springs	2,500	15,000	45 gpcd	4,000	20,000	45 gpcd	4,500	35,000	45 gpcd
Fredericksburg	3,000	20,000	N/A	4,500	25,000	45 gpcd	5,000	40,000	45 gpcd
Menard	3,000	20,000	N/A	4,500	25,000	40 gpcd	5,500	40,000	40 gpcd
San Marcos	2,500	15,000	N/A	4,000	20,000	N/A	4,500	30,000	40 gpcd
Wimberley	2,500	15,000	N/A	4,000	20,000	45 gpcd	4,500	30,000	40 gpcd

*During critical drought years only, to maintain at least "marginally manageable" backup supply system; 50 gpcd average usage rate in other years

As a point of comparison with average size houses, examination of a number of standard 1-story house plans offered by builders active in the Hill Country indicates that a 3-4 bedroom house plus garage would provide ~3,500 ft² of roofprint. This indicates that to right-size houses for RWH would require the addition of ~1,000 ft² of roofprint for most locations. That may be provided by adding on verandas around the house. For smaller houses that may serve the seniors market, it is to be expected that the house, a garage and a modest amount of covered patio/porch would provide 2,500 ft² of roofprint, so in most locations houses for this market would not require any extra roofprint.

In Table 3, the RWH system roofprint and cistern capacity configurations indicated by the model to be required to support the high usage (60 GPCD interior usage) scenario for 4-person occupancy are shown for each modeling location. Also shown is whether or not curtailment of usage would be required for the listed configuration of RWH facilities to be sufficient. "Yes" indicates that the facilities would have incurred no worse than a marginally manageable backup supply requirement only under the curtailment scenario used in the model, and a "no" would mean that configuration would be sufficient without curtailment being required.

Also shown in Table 3 are the configurations indicated by the model to be required in order to supply all irrigation usage from the rainwater system. Also shown is whether some curtailment of irrigation usage would have had to be imposed during the critical drought periods in order for at least a marginally manageable tanker truck backup supply system to have been maintained.

Comparing the configurations in Table 2 to those in Table 3 again highlights two conditions expected to be critical to cost efficient implementation of the RWH water supply strategy being investigated by this project. In the case of the high usage configurations, the value of more disciplined demand control, as noted throughout the modeling summary reviews, is underscored.

Considering the configurations required to provide all irrigation supply from the rainwater system, the value of employing wastewater reuse to defray irrigation usage is highlighted. As reviewed above, by practicing wastewater reuse, the base RWH system configuration, right-sized to supply interior usage only, could be employed while incurring little – in any – increase in backup supply requirements.

Table 3: Summary of RWH Facilities for Higher Usage Scenarios by Modeling Location.

SUMMARY OF RWH FACILITIES FOR HIGHER USAGE SCENARIOS						
Modeling Location	To provide for 60 gpcd interior usage rate*			To cover modeled irrigation usage*		
	Roofprint (sq. ft.)	Cistern Size (gallons)	Curtailment Required? (1)	Roofprint (sq. ft.)	Cistern Size (gallons)	Curtailment Required? (2)
Austin	6,000	55,000	No	7,500	55,000	Yes
Blanco	6,000	55,000	Yes	7,500	55,000	Yes
Boerne	6,000	55,000	Yes	7,500	55,000	Yes
Burnet	5,500	50,000	No	7,000	50,000	Yes
Dripping Springs	6,000	50,000	No	7,500	50,000	Yes
Fredericksburg	6,500	55,000	Yes	7,500	55,000	Yes
Menard	7,000	55,000	Yes	8,500	60,000	Yes
San Marcos	6,000	50,000	Yes	7,000	55,000	Yes
Wimberley	6,000	50,000	No	7,000	50,000	Yes

* For a 4-person occupancy scenario
(1) Standard curtailment scenario required to maintain at least "marginally manageable" backup supply system
(2) Only irrigation usage curtailed to maintain at least "marginally manageable" backup supply system

It is understood that some form of wastewater management system to serve the house must be paid for in any case. There may of course be a premium cost incurred to provide high quality pretreatment to reclaim the wastewater, and to disperse the reclaimed water in a subsurface drip irrigation field, which could be arrayed to provide high efficiency irrigation of the highest value landscaping. (Note that this strategy has routinely been approved as an on-site wastewater system by several jurisdictions in and around the Hill Country for well over a decade, that this is *not* a new and untried method. This type of wastewater system can routinely be implemented.) Given the scale of the increases in RWH system footprint and cistern capacity between those listed in Table 2 and Table 3, it is to be expected that this cost would be considerably less than the premium cost of increasing the sizes of those facilities. This also is a matter to be considered when setting public policy to guide or govern this water supply strategy.

This information and these observations are offered to inform this project about rainwater harvesting facility requirements, to guide preparation of the costs that will be incurred to implement the proposed residential-scale rainwater harvesting water supply strategy, and to inform action on the various policy issues noted in this report.

III. Governmental/Regulatory Status of Residential-scale Rainwater Harvesting for Water Supply

Efforts have been made during the course of this project to engage the governmental/regulatory agents who may place limits or restrictions on the proposed use of individual residential-scale RWH systems as the water supply strategy for all buildings in new developments. Despite significant outreach efforts, little response or interaction has been obtained. Thus, little specific information has been compiled regarding governmental/regulatory issues and the conditions under which this rainwater harvesting water supply strategy may be implemented. Section III reviews the matters which are outstanding, first with the Texas Commission on Environmental Quality (TCEQ) regulatory system and then with county governments.

TCEQ Regulatory System

Communications with TCEQ have confirmed that a residential-scale RWH system will retain its current unregulated status, unless there is a direct connection of that property to a public water supply system. In that case, subsequent to a legislative dictate, rules are being developed to govern that situation. Release of those rules for comment has been delayed and they have not been made available as of this writing. These rules, whatever they turn out to require, might only impinge on the water supply strategy under consideration in this project if the means of providing backup supply is a connection to a public water supply system.

What has not been clarified is the status of other means of providing backup water supply. A critical determination is the status of this water. It would be deposited into the rainwater cistern. It is understood that, if this were a regulated water supply system, the water in the cistern would *not* be classified as potable water, and it would not become potable until after it passed through the treatment unit. Therefore, it is brought to question whether the backup supply system has to conform in *all* regards to rules in Chapter 290 governing either trucked water or piped water. Those rules presume that either of these supplies would be the *only* source of water supply, and so they contain provisions relating to capacity which would seem not applicable to a water source that is used only as an occasional backup water supply.

For a trucked backup supply, the water hauler may not have to comply with Chapter 290 regulations stipulating the type and design details of the tank and the filling and draining appurtenances. Trucks which deliver only to RWH system cisterns may be excused from those rules, just as the water hauler does not have an obligation to assure supply capacity relative to the number of users served, which Chapter 290 stipulates for water hauling that comprises the only source of water supply to a water system. It must be clarified exactly what rules covering water hauling operations generally do and do not apply to trucked-in supplies to be deposited into the cisterns of these unregulated RWH systems.

A similar consideration is needed in regard to water produced from a well and delivered to the cistern in a pipe. It has been called to question whether the pipe system would need to comply in all regards to Chapter 290 rules for water distribution systems. This would apply to various design details, the most impactful being the sizes of the pipes. Again, this distribution system needs to accommodate only an occasional draw for backup supply. In particular, the water could be delivered to the cistern at an instantaneous flow rate well below the peak water usage rates in the building, so all of the sizing presumptions in Chapter 290 would not be required to assure

adequate capacity for the capability of this distribution system. This matter too needs to be clarified.

It may also be that the water produced from the well, and its storage, do not need to comply with all the rules of Chapter 290 regarding treatment, tank size, etc. Perhaps the well could be addressed instead as private well, without regard to how many connections may be able to access a backup supply from that well. Regulations covering drilling and completion of the well would still apply – it would still be a well in any case – but treatment and disinfection requirements for a public water supply in Chapter 290 may not apply. And the Chapter 290 requirements for storage tank size relative to the number of connections would also appear to be not applicable. These matters also must be clarified.

Finally, the unregulated status of the treatment provided to the cistern water before being routed to potable uses may be considered. It has been brought to question if a standardized or minimum treatment train should be defined, or if this matter should continue in its current caveat emptor status. This might be considered at the TCEQ regulatory level, or at the county governance level, as reviewed in below.

In summary, the status of and rules regarding backup supply systems need to be investigated and clarified, and rules applying to a residential-scale RWH for which the backup supply system is a public water supply connection on the property need to be reviewed. These matters must be reviewed in order to resolve what rules would or would not apply to a water supply system for a whole development in which each building has its own residential-scale RWH system.

County Governmental System

Provisions must be made when creating a subdivision supplied by rainwater to assure a safe and adequate water supply to each building. This concept is encapsulated in the shorthand term water availability. Surprisingly, requirements for demonstrating water availability when applying for a subdivision plat are very uneven among various county governments. Despite the state government having determined almost a quarter century ago that explicit requirements to assure water supply to new subdivisions were necessary in economically distressed counties, mainly near the Texas-Mexico border, it has not made that a universal requirement for all counties. Many counties essentially have no requirements to demonstrate water availability. Some merely require minimum lot sizes if private wells are the presumed water source, typically driven by the Chapter 285 regulations governing on-site wastewater systems, with no requirements to show that an adequate well could actually be drilled on each lot. In order to lend certainty to the platting requirements for subdivision proposing residential-scale RWH systems as the water supply strategy for all lots in the subdivision, it must be clarified what, if any, requirements to demonstrate water availability must be provided when applying for the subdivision plat.

At present the practice of rainwater harvesting is a choice made unilaterally by the property owner, typically in the context of a lot which was platted with the presumption that the water source would be a private well. This being the case, it is not surprising that many county governments would take a hands-off approach, leaving the implementation and oversight of those RWH systems to a caveat emptor status. It is brought to question, however, whether a similar viewpoint would be applied if it were to be declared in the platting process that water supply would be provided by RWH systems, instead of wells or the extension of an existing water system line or the creation of a new public water system supplied by a community well. In

that circumstance, the Commissioners Court may understand that they are blessing or approving this form of water supply, and so might question if the county government has some duty to assure that arrangements are made to reasonably assure that each lot would have a safe and adequate water supply.

When the water supply system is RWH, it is understood that water availability depends in large part on right-sizing the system so it can be expected that backup supply requirements would be reasonably low that the owners could reasonably expect to obtain backup supply whenever needed, or upon there being available a sufficiently robust backup supply system to cover whatever choices were made about RWH system sizing. This would imply that, in order to demonstrate water availability in the platting process, there would be a requirement for setting forth the right-sizing of the RWH systems and/or stipulations on the organization and execution of a backup supply system. It must be investigated whether the Commissioners Court in each county would consider these matters to be obligations to the eventual owners of lots in the subdivisions that their county creates, or if they would choose to continue a hands-off policy in regard to residential-scale RWH systems.

Likewise, if an obligation to assure a safe and adequate water supply to each lot is perceived by a Commissioners Court, it may be brought to question if this extends to stipulation of a standardized or minimum treatment train and/or to on-going governance issues. In particular, whether O&M of the individual residential-scale RWH systems would be left to a caveat emptor status, or whether it should be subject to some oversight. Given that the residential-scale RWH strategy would be posed as the water supply system for an entire subdivision, the view might be taken that on-going operations need to be on some organized basis, and that such an organization might need to be set forth as part of the plat application process.

Each county government must be motivated to engage and discuss these matters, and come to a resolution as to the approach to be taken in its county. This is necessary to lend certainty to the platting of a subdivision that would propose to employ this water supply strategy. Currently, it appears this is a “chicken or egg” conundrum. The county governments have, in the main, not given these matters thorough examination because developers have not yet proposed to plat subdivisions presuming that residential-scale RWH would be the water supply strategy, and developers are hesitant to bring such an application before the Commissioners Court without knowing what requirements would be imposed.

It is supposed that counties which currently do not require any demonstration of water availability would take a similar view of residential-scale RWH as the development-wide water supply strategy and not impose any such requirements in the plat application process, while those which do require a demonstration of water availability would consider the degree to which the applicant must demonstrate that these residential-scale RWH systems would indeed provide a safe and adequate water supply to each lot. In any case, the Commissioners Court in each county should provide certainty to the platting process for such a subdivision, and motivating this is a task which largely remains to be completed.

Another aspect of county governance that requires attention is the interplay of RWH with the design sizing requirements for an on-site sewage facility (OSSF). As reviewed in Section II, interior water usage by rainwater harvesters has typically been, and is expected to be, somewhat lower than is presumed in Chapter 285, the rules governing permitting of an OSSF. This should have implications for the per-person design flow criterion of an OSSF serving a building for

which the water supply is RWH, as wastewater flow cannot be greater than the water supply into the house.

In addition, there are certain types of communities – in particular, seniors-oriented communities – where the occupancy would essentially be restricted, by custom if not legally, to 2 people per living unit. But current rules contain a blanket requirement that for every living unit, no matter how small, the presumed occupancy must be at least 3 people. So, regardless of the per-person design flow criterion imposed, an OSSF for this sort of living arrangement would likely be drastically over-sized in any case, if that presumption is applied.

Wastewater reuse for irrigation would be extremely valuable to a rainwater harvester who wished to maintain any significant area of improved landscaping. It is clear that sizing of an OSSF – particularly the more costly OSSF required to provide high quality pretreatment and dispersal in a subsurface drip irrigation field – would be a not-insignificant cost driver for such a rainwater harvester. Thus, a rationalization of the OSSF per-person design flow criterion, and of the occupancy presumptions for specialty communities, is another matter that county governments should consider, as they typically run the OSSF permitting process within their counties. Any such rationalization may entail involvement of TCEQ, which has statewide responsibility for Chapter 285, and for oversight of all the county permitting programs.

Summary and Next Steps for Regulatory Issues

Governmental and regulatory issues remain to be resolved to fully clarify the status of the residential-scale RWH water supply strategy being investigated in this project. This includes the regulatory status and requirements for the RWH system and for whatever arrangements may be made to provide a backup water supply during drought and for the on-going operations and maintenance of the RWH systems.

Further efforts need to be made to engage TCEQ to resolve issues related to the applicability – or not – of Chapter 290 to various aspects of the proposed water supply strategy. Explicit input on each of the matters noted in above is required.

Further efforts also need to be made to engage the various county governments. Each of them needs to determine, and explicitly set forth, the requirements that would be placed on an applicant for a subdivision plat for a development proposing to use the RWH water supply strategy. A means to advance the needed discussion – which was considered by this project, but not executed due to lack of time and resources – may be to conduct a forum or focus group attended by county commissioners and planning agency personnel. Explicit input on each of the matters noted above is required.

Finally, a detailed review of Municipal Governmental Systems is warranted, including a review of existing regulations, and potential barriers and gaps. As with county governments, municipalities will need to determine the requirements that would be placed on an applicant for a subdivision plat for a development proposing to use the RWH water supply strategy. The Meadows Center has engaged the cities of Wimberley and Woodcreek to review their existing and potential future regulations with regard to rainwater collection and harvesting. The results of this activity will be reported in the Cypress Creek Watershed Protection Plan. A draft document with this information will be submitted to TCEQ in December 2013 and a copy will be provided to TWDB. The same activity will be performed for the City of San Marcos in early 2014 and results will be shared with TWDB.

IV. Stakeholder Workshop and Consultations

Stakeholder Workshop and Consultations Goals

This task involved outreach to a variety of stakeholders in order to share the concept of rainwater harvesting at a development-wide scale, to introduce the rainwater harvest model being studied, and to request input, information and insights from those who would plan, design, implement, operate and govern the rainwater harvesting strategy.

Venue and Format

The project team decided that a forum-styled workshop would provide the most suitable framework to deliver the information and to seek inputs from various stakeholders. The venue selected for the workshop was the Lady Bird Johnson Wildflower Center located in south Austin with easy access via Loop1/MoPac Expressway. Cost to rent the Center for a day was minimal (\$500) and the auditorium at the venue provided seating for up to 200, a large screen for delivery of visual presentations, audio and microphone systems, and a comfortable, beautiful setting. The venue was booked for February 10, 2012, and the free workshop was planned from 8:30am to noon for a diverse list of stakeholders. The logo developed to advertise the workshop and stakeholder communications is depicted in Figure 5 below.



Figure 5: Initial Project Logo Developed.

Invitees

Stakeholder groups included developers, homebuilders, architects, planners/engineers, rainwater harvest practitioners, water purveyors, regulatory agents, public policy agents, and public interest groups. More than 200 individuals were emailed an invitation to the Rainwater Harvesting Forum and were encouraged to invite their colleagues who might also share an interest in the subject.

Constant Contact Event Marketing product was used to deliver the invitation, manage the mailing lists, receive registrations, follow up and track invitation lists for the event. (Appendix K is a copy of the original invitation sent via Constant Contact.) The original invitation was emailed on January 5, 2012. A week prior to the February 10th Workshop, a reminder email via Constant Contact was sent to the original list of invitees and the current registrants. By February 8th, 149 individuals had registered for the investigatory workshop. In addition, several guests who had not registered attended the event.

Agenda

Throughout January and up to the date of the event, consultants developed and honed the presentation that would provide attendees with conceptual, theoretical and numerical information

to fully explore the concept of rainwater harvest at the building scale as the primary water supply strategy for an entire subdivision of single-family residences. Special guests from TWDB and River Systems Institute were invited to provide opening comments – Jorge Arroyo (TWDB) and Andrew Sansom (RSI/Meadows Center for Water and the Environment), respectively, agreed to open and provide context for the workshop. Hill Country Alliance (HCA) was a sponsor for the half-day event and sponsored the event’s catered refreshments for attendees. Christy Muse, Executive Director of HCA, set the tone for the workshop by showing a recently produced video about the Texas Hill Country, urging viewers to think differently about how we grow and use natural resources in the future. Christy then introduced the primary speaker for the day, David Venhuizen. (Appendix L is a copy of the Agenda for the Workshop.)

Presentation

David Venhuizen, P.E., explained the strategy of using residential-scale rainwater harvesting systems, a facilities design and management approach, and assurance of backup supply for entire developments. Mr. Venhuizen made the case for rainwater by looking at efficiency, resource availability, cost efficiencies, risk reduction, controllability, reliability, sustainability, energy efficiency, and even drinkability.

The feasibility of this water supply strategy is being evaluated for nine communities in the Texas Hill Country where groundwater resources are already stressed, and rainfall data was collected from each area for the past 25 years. Mr. Venhuizen’s presentation then explored the practicality and cost factors of rainwater harvesting at the development scale by reviewing a variety of factors:

- yield-demand model (rainfall/rooftops/cistern capacity/water use)
- backup supply options
- regulation and governance
- building design issues
- cost effective analysis
- marketability
- sustainability

The first half of the presentation explained the yield-demand model and the variable factors that affect the modeling. The second half of the presentation was an exploration of the remaining factors and a broad request to attending stakeholders to offer suggestions, comments, and ideas as well as to express concerns. David Venhuizen’s entire presentation with notes can be found at the following project links:

<http://www.txhillcountrywater.org/rainwater-harvesting/>

<http://www.twdb.state.tx.us/innovativewater/rainwater/projects/txstate/index.asp>

Results and Findings for Stakeholder Activities

During the closing portion of the workshop, requests were made of attendees to assist with provision of cost details and other areas of the investigation. In addition all attendees received an Information Contribution form with which to provide comments — 23 people responded immediately. We continued outreach to attendees and others who were recommended as solid sources of data to inform our study. Additional contacts were made with engineers, developers, builders, rainwater system designers/installers, architects, well drilling companies, and water

hauling businesses. The volume and level of interest exhibited by the response to our February 10th, 2012 workshop is testament to the focus on alternative water strategies for the Hill Country and Texas. Information was used in project activities and calculations related to backup water supply strategies, cost effective analysis, marketability and sustainability.

Next Steps for Stakeholder Information Gathering

It is important to continue to investigate regulatory and governance aspects, standardized treatment for potable supplies from harvested rainwater, backup water supply strategies, cost effectiveness analysis, marketability and sustainability. Project staff continued throughout the duration of this project to follow up with attendees who indicated willingness to assist with data and information. Any additional information gathered after the completion of this project will be compiled, and assessed for accuracy, to the extent possible and shared with TWDB.

V. Review and Analysis of Backup Supply Strategies

The yield-demand modeling of RWH systems, reviewed in Section II, shows the level of backup supply that is expected to be required, depending on the relationship of building roofprint, cistern volume, and the expected water usage profile in that building. This section is a review of methods of providing that backup supply.

The various methods for providing backup supply that have been identified include:

- Delivery by tanker trucks which obtain water from a public water supply source. This trucking operation may be run by a private water hauler, either under contract or on a fee for service basis, or by an organization set up to serve one or more developments which employ the RWH strategy for water supply.
- Delivery in some form of portable storage, such as a tanker truck, from one or more wells installed in the development solely for the purpose of providing backup supply. This operation may be executed by a contractor or by an organization set up to serve this development.
- Delivery from one or more wells, installed in the development solely for the purpose of providing backup supply, through a minimal distribution pipe system. This pipe system may be sized to deliver the water at the daily average rate of use rather than for whatever the peak usage rate may be, since this flow would be replenishing the cistern volume rather than feeding directly into the house fixtures.
- Obtaining service from a water supply entity through a water distribution system installed within the development. This distribution system may be minimally sized as set forth above, or it may be fully compliant with the rules for a public water supply system, as if it were the only source of water supply.

Review of Backup Supply Options

Tanker Truck from Public Water Supply Source

Delivery in a tanker truck, run by a private water hauler, is the means by which most homeowners currently using RWH for water supply obtain backup supply. Therefore, this method has the advantage of already being set up in its basic outlines. It remains to be determined if the presently operating water haulers could increase their capacities sufficiently to serve an expanded demand, or if new companies might enter the market to provide sufficient capacity. It should also be determined if, instead of using water hauling companies, such a trucking operation could be reasonably and cost efficiently run by an organization established for this purpose by the developer or residents of one or more developments employing the RWH strategy for water supply.

Capacity is a major issue for this option. This can be understood from the following example:

- From the modeling results, at a nominal occupancy and usage rate, it is to be expected that every house in the development may require a load of backup supply in the same month during a critical drought period.
- Trip time would depend on the distance between the development and the water supply source. Consultation with water haulers indicates that time to fill and drain the tanker truck is pretty standard, although fill time may be impacted by the flow rate capability of the source water system. These consultations indicate that, within the self-defined normal service area of each hauler, a truck might make 10 trips per day, under the sort of expanded operating schedule these haulers typically practice during periods of peak demand.
- Presuming that the hauler would operate 6 days per week during these periods of peak demand, there would be about 25 working days per month.
 - Each truck could make ~250 trips in the peak month
 - 250 houses could be serviced by one truck
- If there were many subdivisions employing the RWH water supply strategy in the area, several trucks may be required to provide adequate backup supply during a critical drought period.
- If these subdivisions are located further from available water sources, the capacity may decrease due to longer trip times.
- A fleet would have to be capitalized to provide the capacity expected to be required during the critical drought period.
- These trucks may be stranded assets, with no profitable uses during non-drought periods.

From this review, it can be seen that the ability of the existing water haulers to keep up or reliably provide services, would depend upon how widespread the RWH strategy was practiced, how well the RWH systems were right sized for the expected usage, and how effectively the users could, and would, curtail their water demands during the critical drought periods. It is also questionable how many new trucks might be capitalized, given that they may become stranded assets during non-drought periods. The latter issue also applies to the entry of new water haulers into the market. In this case, lacking an established clientele, the reluctance to capitalize new trucks may be even greater.

Because of this, it may fall to the developer, or the residents, of a subdivision employing the RWH strategy to organize their own backup supply system. Capitalizing the truck and arranging for operation of the backup supply system would be part and parcel of setting up the overall water supply strategy. Two or more developments might band together to run such a system. Or a public entity might establish a water district, such as a Water Control and Improvement District (WCID), to run such a system on an area-wide basis, if it were determined that the private sector would not be able to provide the level of service deemed to be necessary. The latter may be a long term strategy to be pursued when some critical number of RWH users exist within an area, addressing this function within a utility structure.

One potential solution to the stranded assets conundrum would be to use flexible bladders, which may be installed in any available truck, or tanks or bladders installed on a trailer, as a much less

expensive alternative to increasing the number of much more expensive tanker trucks. The former option might press into service for backup supply during critical drought periods trucks that are already capitalized, being used for other purposes; for example, the dump trucks used by county road departments. Road maintenance activities might be suspended for a period of time (perhaps one month) during the most critical drought periods while these trucks are used to haul backup supply. Some equitable means of charging for this service would have to be derived.

A potential barrier to using anything but a tanker truck is TCEQ rules pertaining to water hauling for potable water supply. One current water hauler, upon being queried as to whether it might expand its capacity by using bladders rather than capitalizing new trucks, asserted that TCEQ would never approve of hauling water in bladders. This appears to derive from various stipulations in Chapter 290 regarding requirements of tanker trucks that would haul water intended for potable supply.

It is noted, however, that the water in a rainwater cistern, to which the hauled water would be added, is not deemed to be potable water. (Or, more correctly, it would not be deemed potable if a residential-scale RWH system were regulated as a potable water supply system – currently such systems are unregulated.) It therefore may be called to question if those rules would necessarily apply to a hauling operation dedicated solely to adding backup supply to a RWH system cistern, since this water would be run through a treatment system before being used for potable supply in the building. TCEQ has been queried regarding this issue. Discussions of this matter are on-going.

If the specific requirements placed upon tanker trucks hauling water for potable supply were deemed not to apply to this situation, it still must be determined how and to what degree any hauling operation *would* be regulated by TCEQ. Perhaps backup supplies dumped into cisterns would be left on a caveat emptor basis, just as whatever treatment is provided to water out of the cistern is presently left totally unregulated (presuming of course that the RWH system does not rise to the level of a public water supply system due to the number of connections or people that it routinely serves). This will need to be clarified if anything but tanker trucks fully compliant with the rules of Chapter 290 are to be used to haul backup supply.

If the backup supply system were left on a caveat emptor basis, then the capacity issues of this strategy could be far more readily dealt with. Residents of a group of houses – over a full development, as a neighborhood association, etc. – could band together to set up a hauling operation using a trailer-mounted containment, operating the system much like a volunteer fire department, or they could contract with a trucker to install a removable bladder in the truck. Thus, they could grow the capacity for backup supply to match their actual needs, in a manner for which they could largely control both the timing and the costs.

Delivery from Local Wells by Water Hauling Operation

This option would be a highly localized version of the strategy reviewed above. With the water source being a well within the development being served, the haul distance would be considerably shorter, so the capacity issues for this strategy would be less severe. It is likely that, if this strategy were employed, provision of backup supply would be limited to buildings within the development. So, while the water hauling could be executed under contract with a private company, the means of hauling the water could instead be directly under the control of the residents, or of an entity set up explicitly for this purpose. In the latter case, whatever equipment was capitalized would likely be dedicated solely to serving this development.

Here again, an option would be to use means other than a tanker truck meeting all the requirements of Chapter 290 for potable water hauling. And again this would be subject to determining what regulatory requirements would apply to hauling of water to be delivered into the RWH system cisterns, a supply which is not deemed to be potable.

Here also, requirements applied to well(s) from which the backup water supply would be drawn need to be clarified. Chapter 290 stipulates requirements that presume the well is the sole source of water supply for the users drawing from it, while in this case it would be a source for only occasional backup supply requirements. Further, again the water would not be delivered as a potable supply, rather dumped into the RWH system cistern and go through a treatment process before being used as a potable supply in the building. TCEQ has been queried regarding what rules would apply and how they would be interpreted in this case, and discussion of this matter is on-going.

Another issue with this strategy is limitation of withdrawals from the well(s). One of the drivers of the RWH strategy will be limited groundwater availability. In some circumstances, using the RWH strategy rather than depending on local groundwater would allow higher intensity development – e.g., the Hays County provision for a 6-acre minimum lot size for developments drawing water supply from the Trinity Aquifer, vs. lots as small as 1 acre with some other water supply options, RWH among them. Under such rules, it must be determined if wells could be used solely for backup supply without running afoul of the lot size restrictions. If so, it must be determined how to assure that the wells are not pumped for more routine water supply – e.g., for increasing irrigation usage – rather than *just* for the level of backup supply indicated by the right sizing analysis that sets the expectations of backup supply needs. These matters were to be investigated by this project, part of the review of county-level governance as applied to the RWH strategy, but little cooperation by the county governments has been obtained, leaving such investigations to be pursued in future investigations.

Delivery from Local Wells through a Minimal Distribution System

This strategy would also obtain the backup water supply from a well or wells installed within the development, but would deliver the water from the well to the cisterns through a minimal water distribution pipe system. Since water could be delivered to one cistern – or at most a very few cisterns – at a time at an average rather than a peak usage flow rate, the pipes could be rather minimally sized, likely no larger than 2 inches, while still providing adequate capacity.

In this case also, what Chapter 290 regulations would apply to the well must be determined, as well as for the distribution system. Chapter 290 addresses water distribution systems solely with the presumption that these pipes provide the *only* water supply to the system users, not on the basis that this is only a very occasional draw of backup supply. Therefore, it must first be determined if a minimally sized system could be allowed at all, and if so upon what basis the minimal size would be determined. Here again, since the water in the RWH system cisterns, to which the backup supply would be added, is deemed not potable, it may be questioned if any aspect of such a backup supply system should be governed by the rules in Chapter 290 which are intended to govern and regulate potable water supply systems only. Discussion of this situation with TCEQ is on-going.

An option which would appear to steer clear of the Chapter 290 restrictions would be to connect each well and distribution system to less than 15 connections, serving a design population of less

than 25 people, so that the entire backup supply system does not rise to the level of a public water supply system. In this case, the drilling and completion of the well(s) would be subject to applicable regulations, but the standards and governance for all other aspects of the system would appear to be subject only to caveat emptor. The design and operation of that sort of backup supply system would be subject to whatever governance mechanism the developer put in place and/or the residents were to organize. The cost per house that would be incurred for wells under this scheme would, of course be an important factor in determining the merit of this strategy.

Under this strategy, however, it would be even more critical to put in place some means or procedures for limiting draws on the wells providing the backup supply. This is so because with a pipeline running water directly into each cistern, it would be much easier for the users to overdraw. That could result in profligate usage which was not intended in formulating the RWH supply strategy, and thus in an overdraft of groundwater, which the RWH strategy was intended to preclude. Thus, a mechanism for governing and limiting backup water usage would have to be part and parcel of this strategy, at least if availability of groundwater were at issue.

Obtaining Piped Water Service from a Public Water Supply System

This option would be highly situational, subject to there being a public water system supply line within reasonable proximity to the development. In any case, the distribution system within the development would be connected to a public water supply system, so it is questionable if a minimally sized distribution system would be allowed. All the rules applicable to that public water supply system would most definitely apply to this distribution system. Here again, however, since the use of that distribution system is intended to be for occasional backup supply only, and that supply could be delivered at average rather than peak flow rates, an exception to the line size requirements might be obtained. TCEQ has indicated that such an exception may be considered on a case-by-case basis.

Because this option would require an initial (up front) investment in the water main extension and the distribution system, as well as payment of impact fees, connection charges, etc., to the water supply entity, it would blunt or eliminate a major incentive for employing the RWH strategy within the development to begin with. Thus, this strategy might likely be considered only where further increases in the number or full service connections to the public water supply system were limited by water availability. However, that brings to question whether adding connections for backup supply only could be allowed, as this supply would be required only during the critical drought periods, exactly when the public water supply source would be under greatest stress.

In any case, removing the fiscal incentives for using the RWH strategy, this backup supply concept is quite unlikely to be considered within a development where it is intended that RWH be the water supply strategy, and only very occasional backup supplies would be drawn from the piped water system. However, at least one developer considering the RWH strategy has indicated that a public water supply line may also be extended to the development and a distribution system would be installed, so it has been included here for discussion.

Summary of Back-up Supply Options

Further evaluations of other options are recommended, but given the uncertainties and the level of investment required to implement other backup supply options, it is to be expected that the

existing tanker truck delivery system would continue to be the main option for providing backup water supply to users of RWH systems. As noted, this option has the advantage of being already set up and functioning. The basic option might be adapted to be run by an entity such as a neighborhood association rather than by a private sector entity, enhancing the surety of service to that development, but the fiscal and operational viability of that scheme remains to be determined.

The major issues with the existing private sector backup supply strategy are, as noted, the ability of those entities to keep pace with demand when whole subdivisions full of RWH systems are developed, and what the cost of that service would be, particularly if keeping up with capacity required fleet expansion.

Existing Water Hauling Companies Capacity and Cost of Service

As noted, because this method is already in existence and operating, providing backup supply service to rainwater harvesters at present, it is quite likely that the predominant method of backup supply would be obtaining the services of existing water hauling companies. This may continue to be so at least until enough developments utilizing the RWH strategy are on the ground so that the capacity of these water haulers might be strained during a period of critical drought conditions. This section reviews available information regarding the present and planned capacity of these companies, and the costs of these services.

A list of nine water hauling companies has been identified within the Austin/Dripping Springs area as an initial sample of those operations. Each of these companies was queried to determine their capacity, their pricing, and their prospects for capacity expansion. Five of those companies responded. Their characteristics are reviewed in this section and summarized in Table 4. To protect their privacy, the respondents remain anonymous, referred to only by letter.

Reviews of Existing Water Haulers

Company A reports that it has 3 trucks. Two trucks have a capacity of 2,000 gallons per load, and one truck has a capacity of 5,000 gallons. The price of a 2,000-gallon load is \$94, or \$47 per thousand gallons, and the price of a 5,000-gallon load is \$188, or \$37.60 per thousand gallons. These prices apply to delivery within its self-defined service area. Current water sources used by Company A are City of Austin, Dripping Springs Water Supply Company (WSC), and an unspecified Lower Colorado River Authority (LCRA) source, which sets the starting point of each load. The current service area of Company A is western Travis County, Hays County and parts of Blanco County. Company A stated that higher rates would apply for longer trips.

Company A asserted that it plans to add one truck within the next 2 years, indicating that it is anticipating increased demand for water hauling. Within its service area, Company A does not anticipate that its rates would increase due to expansion of the fleet, indicating that it feels that the additional business would be sufficient to capitalize the additional tanker truck. (The price of the new truck was not provided.) It does note that price increases are to be expected due to increasing fuel prices. Company A stated that its trucks lie idle during periods of relatively wet weather, when backup supplies are not needed by RWH system users. It also stated that it would not consider expanding its capacity in any manner except with additional tanker trucks.

Company A asserted that, within its service area, it could make a maximum of 10 trips per truck per day, if its operating hours were expanded. It stated that the normal number of trips per truck

per day would be 6. Assuming 25 working days per month, this implies 150-250 trips per truck could be made in a month. With its current fleet of 3 trucks, this implies a capacity of 450-750 loads of water could be delivered in a month. Assuming that during a critical drought period every house in a development would need a load of backup water in a month, this implies that Company A could service up to 750 houses.

Company B reported that it operates 2 trucks. One truck has a capacity of 1,500 gallons per load, and one truck has a capacity of 2,000 gallons. No prices were provided, stating only that it depends on truck size and location of the delivery. Company B stated that price would vary with length of trip. Sources used by Company B were stated to be “All potable sources through permits and meters.” The service area of Company B was stated to depend “on needs at the time.”

Company B asserted that it plans to add two more trucks within the next year, indicating that it is anticipating increased demand for water hauling. Company B does anticipate that its rates will increase, but did not clarify if that would be due to expansion of the fleet or other reasons, such as increasing fuel costs. Company B stated that its trucks lie idle during periods of relatively wet weather, when backup supplies are not needed by RWH system users. It also stated that it would perhaps consider expanding its capacity by using bladders instead of additional tanker trucks.

Company B asserted that, within its service area, it could make a maximum of 15 trips per truck per day, if its operating hours were expanded to 16 hours. It stated that fill and drain time would be 15-20 minutes each, leaving only about a half hour per trip for travel time. This implies that trip length must be limited in order to fit that many trips into a day, so would apply only to a limited operating area. As noted above, Company B did not define a service area. Accepting that 15 trips a day could be made, and assuming 25 working days per month, this implies 375 trips per truck could be made in a month. With its current fleet of 2 trucks, this implies a capacity of 750 loads of water could be delivered in a month. Assuming that during a critical drought period every house in a development would need a load of backup water in a month, this implies that Company B could service up to 750 houses.

Company C reported that it has 3 trucks. Two trucks have a capacity of 2,000 gallons per load, and one truck has a capacity of 4,000 gallons. The price of a 2,000-gallon load is \$85, or \$42.50 per thousand gallons. These prices apply to delivery within 10 miles of Dripping Springs. Current water sources used by Company C are City of Austin, Dripping Springs WSC, Canyon Lake WSC, and an unspecified LCRA source, which sets the starting point of each load. The current service area of Company C is stated to be “Hays and surrounding counties.” Company C stated that the price for longer trips would be based on trip length.

Company C asserted that it has no specific plans to add more trucks, but stated that “additional trucks could be purchased” if market conditions so dictated. Company C anticipates that its rates would increase only based on water and fuel costs, indicating that it feels that the additional business would be sufficient to capitalize additional tanker trucks. Company C stated its trucks are also used to fill swimming pools and for special events, helping to fill in activity during periods of relatively wet weather, when backup supplies are not needed by RWH system users, but noted that business does routinely slow down considerably in the winter. Company C also stated that it would not consider expanding its capacity in any manner except with additional tanker trucks.

Company C asserted that, within its service area, it could make 20-30 trips per day with its whole fleet. Assuming 25 working days per month, this implies 500-750 trips could be made in a month. Assuming that every house in a development would need a load of backup water in month, this implies that Company C could service up to 750 houses.

Company D has 3 trucks. Two trucks have a capacity of 2,000 gallons per load, and one truck has a capacity of 4,200 gallons. The price of a 2,000-gallon load is \$90, or \$45 per thousand gallons, and the price of a 4,200-gallon load is \$180, or \$42.85 per thousand gallons. These prices apply to delivery near Dripping Springs. Current water sources used by Company D are City of Austin and Dripping Springs WSC, which sets the starting point of each load. The current service area of Company D is stated to be within a 70 mile radius of Dripping Springs, but asserted it could deliver water anywhere in Texas. It does not expect prices to change much in the next few years, except for increases in diesel fuel price.

Company D asserted that it plans to add 1-3 more trucks this year, indicating that it is anticipating increased demand for water hauling. Company D does not anticipate that its rates would increase due to expansion of the fleet, indicating that it feels that the additional business would be sufficient to capitalize additional tanker trucks. Company D stated that its trucks do not lie idle during periods of relatively wet weather, that they stay busy year round, but did not specify what that business consists of when RWH systems do not require backup supply. It also stated that it would not consider expanding its capacity in any manner except with additional tanker trucks, explicitly noting that TCEQ requires these trucks have to be engineered and approved.

Company D asserted that it provided supply to over 400 households in Dripping Springs every summer. It asserted it could make up to 15 trips per truck per day, if its operating hours were expanded, but as noted for Company B, this implies all the trips must be quite short. Taking the 400 households as the routine capacity of Company D provides an estimate of the number of houses it can serve with its existing fleet.

Company E reported that it has one 2,500-gallon truck and that it serves Austin and surrounding areas. The price of a truckload delivered in this area is reported to be \$125, equating to a water price of \$50 per thousand gallons. Company E stated that higher prices would be charged for longer trips, based on judgment. Its water sources were not specified. Company E asserted that only 5% of its business was hauling backup water supply to rainwater harvesters, but did not state what the bulk of its business consists of. It also stated it had no plans for expansion, no other uses for its truck other than hauling water for backup supply, and that its truck lies idle during wet years when backup supply is not needed.

Company E stated that its operating hours were when needed, and that the number of truck trips it could make varies on job. No basis for estimating the number of trips per month was offered. Presuming the service capabilities of Company E are similar to the other respondents, it is estimated that Company E might serve about 250 homes during a critical drought.

Table 4: Summary of Water Hauler Information.

Company	Trucks	Service Area	Service Capacity (#homes/mo.)	Water Price Per 1000 gal	Water Source	Expansion
A	2- 2000 gal 1 -5000 gal	western Travis Co, Hays Co and parts of	750	\$37.60-47.00	City of Austin, Dripping Springs WSC, unspecified	1 truck in 2 yrs.

		Blanco Co			LCRA source	
B	1- 1500 gal 1 -2000 gal	varies	750	Varies	Not specific – “All potable sources through permits and meters”	2 trucks in 1 yr.
C	2- 2000 gal 1 -4000 gal	Hays and surrounding counties	750	\$42.50	City of Austin, Dripping Springs WSC, Canyon Lake WSC, unspecified LCRA source	Not planned, but willing to expand
D	2- 2000 gal 1 -4200 gal	70 mile radius of Dripping Springs (can travel further)	400+	\$42.85-45.00	City of Austin, Dripping Springs WSC	1-3 trucks in 1 yr.
E	1 – 2500 gal	Austin area	250 homes	\$50.00	Not specified	Not planned

Viability of Backup Supply from Private Water Haulers

From this information, it does appear that the capacity of 250 houses per month per truck estimated previously generally matches what these companies assert they can provide. However, again noting the time required to fill and drain the tanker truck, this capacity might only be approached if the trip time is fairly short, no longer than 30 minutes. If developments employing the RWH strategy were located further afield from available water sources, it is to be expected that this capacity per truck would decrease.

Given the current capacity reported by these 5 companies, given that all but one of them expect to expand their fleets, and given that there are 4 more companies that did not respond operating in the same general area, it appears there is currently considerable capacity available for RWH system backup supply. Thus it appears that, in this area, a fairly large number of buildings employing the RWH strategy for water supply could require a truckload of backup supply in any given month without straining the capacity of the existing water hauling companies. It remains to determine how much of their capacity is currently taken and how much may be available for *new* subdivisions full of RWH systems. Further investigations are recommended to refine the backup supply capacity that can be expected to be provided by private sector water haulers.

It also remains to determine whether the situation is similar in other parts of the Hill Country where RWH subdivisions might be located, if the sort of capacity apparently available in the Austin/Dripping Springs area is common or is an aberration. It is recommended to canvas those areas to identify water haulers which may serve them, and to solicit the same input from all companies identified in that process.

Availability of service in the abstract does not guarantee delivery of service in a timely manner, however. A developer, or collective action by residents, may attempt to obtain a contract with a water hauler to guarantee timely service to every building in that development. It is recommended to also query water haulers regarding whether they would accept such a contract, and what its price may be, over and above the water charges.

Indeed, when considering approval of the plat for a development for which RWH is the proposed water supply strategy, having such a contract in place may be deemed by the Commissioners

Court to be a necessary part of demonstrating water availability. Determining the likelihood of such a requirement being imposed is recommended as further work in regard to establishing the regulatory environment for using RWH as the development-wide water supply strategy.

Back Up Supply Summary

The preliminary indication from the feedback provided to date is that, at least in the part of the Hill Country where the identified water haulers focus their services, the existing capacity and planned increases of capacity of those existing water haulers would be able to serve a fairly large number of buildings with backup water supply. That presumes that RWH systems would be right sized and the users would act so that backup requirements would be sufficiently minimal. It remains to be seen how this capacity compares with the present market. This will reveal the amount of extra capacity available, or that is expected to become available as a matter of course, to serve whole *new* subdivisions filled with RWH systems. It is recommended that continuing investigations address this matter.

As noted previously, an option would be to form an entity – a neighborhood association, some sort of utility structure, etc. – to run a dedicated trucked backup supply system for one or more developments. The costs, operational issues, and regulatory hurdles for such an entity remain to be determined. There is a particular need to engage TCEQ in reviewing and discussing how its present rules, which are focused exclusively on the operations of conventional water supply systems, may apply to an operation run solely to provide relatively infrequent backup supply rather than being the only supply stream for the users.

Further evaluation of the other options is also recommended, as the information on regulatory issues and costs becomes available. Again, information from TCEQ must be solicited regarding the regulatory issues. Further attempts are also recommended to gather cost information, to determine installation and operating costs of wells for backup supply, cost of the means for transporting water from the well to the cisterns, and costs for distribution pipe systems. All of these activities, required to gain a more complete understanding of backup supply options, are beyond the scope of what can be supported within the present project.

For the present, it appears it can be presumed that a large number of new buildings employing RWH for water supply could be supported by the private sector water haulers, at least within the areas served by the water haulers identified by this project. It remains to be determined what the limit of that capability may be, and if the situation is similar in other areas of the project's prime focus area, the Texas Hill Country counties.

VI. Hydrologic Impact of Broadscale Rainwater Harvesting Systems in a Watershed

It has been brought to question whether populating the landscape with rooftops from which rainwater is harvested rather than allowed to run off would reduce available overland flow from rain events, and so degrade the hydrologic environment, and perhaps impinge on downstream water rights. This report provides preliminary analyses to determine if any significant reductions in runoff or instream flow will result from the introduction of subdivision scale rainwater harvesting systems in typical Central Texas watersheds. Analyses are reviewed at multiple levels:

- The roofprint area is examined in isolation, comparing the amount of cistern overflow expected – this is derived from the rainwater harvesting model – with the runoff that would flow off the native site area of this size.
- A full development is examined as a watershed, comparing the native site to the developed site with and without rainwater harvesting being practiced.

These efforts highlight that the comparison of interest is the runoff that would have occurred in the native state of the land vs. the runoff that occurs from the developed site with RWH being employed. All initial findings show that there is no measurable change in the quantities of runoff or available rainfall for stream flows from rain events where rainwater harvesting at a subdivision wide scale is occurring.

Modeling Parameters

Each of the first two analyses employs a 20-year daily rainfall model. The rainfall data used is from the Austin, TX weather station for the period of 1978 through 1997. Because the data covers two decades, through wetter and drier years (higher and lower average rainfall), it is considered indicative of typical results that may be expected at any other location in the Texas Hill Country, the primary focus area of this project. The overall average annual rainfall derived from this data set is 34.14 inches, while the long term average for Austin is 32.5 inches, so overall this 20-year period was slightly wetter than average.

For the analysis considering the roofprint area only, 4,500 ft² is used in calculations. That is the roofprint indicated by the RWH modeling that would be needed to right-size a 3-4 bedroom home. (See the modeling results in Section II, Review of Rainwater System Modeling for a definition and review of right sizing.) The runoff from this roofprint is compared to the runoff from the native surface it would cover using the Soil Conservation Service (SCS) method for estimating runoff.

For the analysis considering the entire area of a development, a proposed project in the Hill Country, located near Dripping Springs was used as the base watershed area. This project is to contain 82 lots, thus 82 houses, on 164 acres. Each house is presumed to have a roofprint of 4,500 ft². Another 1,000 ft² of impervious cover per lot is also presumed, to account for the driveway, sidewalks, uncovered patio areas, etc. The road length measured off the development plan is 10,700 linear feet, and it is presumed that the average pavement width would be 30 feet. Altogether, these define the impervious coverage of the development, working out to be 10.8%. The CN (curve number, a measure of the propensity for a landscape to shed water) presumed for all impervious surfaces is 98. It was also presumed that each lot would have 2,500 ft² of improved landscaping, installed on fill dirt, for which the CN is presumed to be 74. This is derived from the City of Austin Drainage Criteria Manual¹, for a lawn on Group C soils.

To investigate the situation with a higher intensity of development, the total project area was reduced and the roadway length was adjusted, to yield an overall impervious cover of ~15%. The roofprint and other impervious cover per lot remained the same, so the reduced project area reflects a smaller area of land left in the native site condition. This process was repeated to generate a development scenario with ~20% impervious cover and a scenario with ~25%

¹ [http://austintech.amlegal.com/nxt/gateway.dll/Texas/drainage/Cityofaustintexasdrainagecriteriamanual?=/templates\\$fn=default.htm\\$3.0\\$vid=amlegal:austin_drainage\\$anc=](http://austintech.amlegal.com/nxt/gateway.dll/Texas/drainage/Cityofaustintexasdrainagecriteriamanual?=/templates$fn=default.htm$3.0$vid=amlegal:austin_drainage$anc=)

impervious cover. Each of these scenarios was analyzed using various presumptions of the native site CN.

Given the CN presumed for the native surfaces, the composite CN for the whole development can be calculated. This is done for the development presuming RWH is not practiced, in which case the rooftop areas are included in the impervious surface calculation, and presuming RWH is practiced, omitting the rooftop areas from the impervious surface area. The CN derived in each case is used to calculate the runoff that would have been generated by the amount of rainfall received each day, throughout the 20-year period of the model. The model runs the calculations year by year and totals the modeled runoff from the native site, the modeled runoff from the project without RWH, and the modeled runoff from the project with RWH. In the latter case, the cistern overflows, calculated by the RWH model used to create the rooftop-only analysis, are added to the runoff modeled in that analysis.

For each of the impervious coverage scenarios, four cases were examined, assuming various hydrologic conditions of the native site. The cover complex was presumed to be pasture or range in all cases. Reviewing soil maps for a random sample of currently undeveloped land in the Hill Country, it was found that most soils fall into either Group C or Group D. On any given parcel, one or the other may dominate. The four conditions include:

- Group D soils predominate, in poor hydrologic condition, CN = 89.
- Group D soils predominate, in fair hydrologic condition, CN = 84.
- Group C soils predominate, in fair hydrologic condition, CN = 79.
- Group C soils predominate, in good hydrologic condition, CN = 74.

The CNs listed above are derived from Table 7.1 of the SCS National Engineering Handbook, Section 4, Hydrology. Hydrologic conditions for pasture or range land are defined in Table 6.1 of that handbook, as follows:

- Poor hydrologic condition – Heavily grazed. Has no mulch or has plant cover on less than half of the area. Certainly there are areas of the Hill Country that would fit that description.
- Fair hydrologic condition – Not heavily grazed. Has plant cover on half to three quarters of the area. This is a more generally typical condition of much of the Hill Country.
- Good hydrologic condition – Lightly grazed. Has plant cover on more than three quarters of the area.

Much of the land which has not been grazed by livestock in recent years may fall into this category, depending on how highly degraded the land was when grazing ceased.

A Group C soil covered by pasture or range in poor hydrologic condition would have a CN = 86. A Group D soil covered by pasture or range in good hydrologic condition would have a CN = 80. So the CN range of 74-89 used in this analysis covers the range of conditions expected to predominate the native site area.

It is noted that some of the development area may be covered by woods, which would generally have a lower CN, shown in Table 7.1 to be as low as 70 with Group C soils and the cover in good hydrologic condition. The analysis will show, however, that the least favorable runoff

comparisons occur if the native site has a higher CN, so the potential lower CN provided by a cover of woods is not modeled in this analysis.

Analysis of Roofprint Area Only

A rather severe analysis is offered by considering the change in runoff generated only from the building roofprint – the rainwater collection area – vs. the native site area that this roofprint would cover. The only runoff from the roofprint would be overflow from the cistern. This would occur whenever a sufficiently large amount of rain fell to fill the cistern and cause an overflow. Runoff would be generated from the native site area on any day that the amount of rainfall was above the threshold of the initial abstraction of this surface, which is determined by the CN presumed.

This analysis is considered severe because it neglects runoff from any other impervious surfaces on the project – e.g., the streets and driveways – and because some of the runoff from the native site area may be abstracted downslope of the house site. It is offered to provide an indication of a worst case of how much the broadscale practice of rainwater harvesting may impact the watershed. The results of this analysis are displayed in Table 5 through Table 8, for native site CN of 89, 84, 79 and 74, respectively.

These results show that the greatest loss of runoff would be incurred if the native site has a rather high CN – that is, the site would be covered with Group D soils in poorer hydrologic condition – which would generate more runoff in the native condition. Table 5 shows that, with a CN = 89, the net loss of runoff would have ranged from negative 0.392 ac-ft/acre (that is, the cistern overflow in that year would be greater than the runoff generated from the native site area) to a maximum of 0.785 ac-ft/acre. The magnitude of the net loss is a happenstance of rainfall patterns and annual totals. Low annual rainfalls typically do not generate cistern overflows, but also may lead to lower runoff from the native site area, depending on whether the rains come as many smaller storms or fewer larger storms. The 20 year average net loss of runoff under this scenario is shown in Table 5 to be 0.305 ac-ft/acre/year. Net loss would have been positive – that is, more runoff from the native site area than cistern overflow would have occurred – in 17 of the 20 years covered by the analysis.

Tables 6-8 show that, as the hydrologic condition of the native site improves and/or the site has Group C rather than Group D soils, the net loss of runoff decreases considerably. Table 6 shows that at a CN of 84, the 20-year average net loss is down to 0.027 ac-ft/acre/year, with the peak year dropping to 0.530 ac-ft/acre. Net loss would have been positive in 11 out of the 20 years covered by the analysis. In the other 9 years, replacing the native site area with roofprint and rainwater harvesting off it, with some cistern overflows resulting, would have increased the total amount of runoff.

Table 7 shows that at a CN of 79, the average net loss goes to negative 0.155 ac-ft/acre/year – again, that means that the cistern overflow, on average, would have been that much greater than the native site area runoff would have been. The peak year net loss would have decreased to 0.362 ac-ft/acre. Net loss would have been positive in only 9 years, with the cistern overflow being larger than the native site runoff in the other 11 years.

Table 8 shows that at a CN of 74, the average net loss goes to negative 0.279 ac-ft/acre/year, with the peak year net loss dropping to 0.245 ac-ft/acre. Net loss would have been positive in only 8 years. In 4 of those years, the net loss would have been less than 0.1 ac-ft/acre/year. In the

other 12 years, cistern overflow would have been greater than the native site area runoff. The largest such excess would have been 1.239 ac-ft/acre.

If rainwater harvesting had not been practiced, Tables 5-8 show that runoff from the roofprint area would have increased greatly over that generated by the native site area. The 20 year averages range from 247% if the native site area CN = 89 (Table 5) to 1343% if the native site area CN = 74 (Table 8). This alteration of the hydrologic condition imparted by development – covering the land with impervious surfaces – typically imposes a requirement to install various stormwater management devices, such as detention ponds, to mitigate such situations. Overall then, sequestering most of the roof runoff in a rainwater cistern would minimize some negative impacts to the hydrologic integrity of the watershed. This analysis indicates that only if the native site area is in rather poor hydrologic condition might there be any significant reduction or sequestration of runoff by the RWH systems.

Project-Scale Hydrologic Analysis

While the roofprint-only analysis provided worst case implications of the broadscale practice of RWH within a watershed, the project-scale analysis offers a more realistic view. This analysis takes into account all the alterations made over the entire development, rather than just the replacement of native site areas with roofprint. As noted previously, it includes roadways and driveways and the alterations to the land treatment by installing improved landscaping on the lots. Summaries of the results of this analysis are displayed in Tables 11-24. Complete results tables are displayed in Appendix N.

Projects with ~10% impervious cover are evaluated with the following parameters: 82 houses, 164 acres, 10,700 linear ft. road, 4,500 ft² roof print per lot, 1,000 ft² other impervious cover per lot and 2,500 ft² improved landscape per lot. In Table 9, the CN of the native site is presumed to be 89 – Group D soils in poor hydrologic condition. As noted, this is a rather degraded condition. Table 9 shows native site runoff would have averaged 139.69 ac-ft/year over the 20 year period. The table displays the change in runoff relative to that modeled for the native site with and without RWH being practiced. This is the only case in which, with RWH being practiced, the runoff would have fairly consistently been lower than what would have issued from the native site. This was the case in 16 of the 20 years covered by the analysis. However, the overall average reduction would have been fairly low, down to an average of 138.01 ac ft./year, a difference of only 1.69 ac-ft/year, which is a reduction of only 1.8%. Over the 164-acre development, this is 0.010 ac-ft/ acre/year. The largest reduction in runoff amount in any one year would have been 5.84 ac-ft, or 0.036 ac-ft/acre. This would have been a 4.5% loss in runoff relative to the native site conditions.

Table 5: Hydrologic Analysis of Roofprint Area, CN = 89.

Hydrologic Analysis of Roofprint Area Only

Native Site CN = 89

Pasture or range, Group D soils, Poor condition

Input Parameters

RWH System Configuration			Interior Water Use		
Roofprint area =	4,500	sq. ft.	Occupancy =	4	persons
Cistern volume =	35,000	gallons	Usage Rate =	50	gpcd
Native Site CN =	89		Daily water use =	200	gallons
S-value =	1.236				

Year	Rainfall in Year (in.)	Native Site Runoff (gal)	Total Roof Runoff (gal)	Net Increase in Runoff (gal)	% Increase in Runoff	Cistern Overflow (gal)	Net Loss of Runoff (gal)	Net Loss (ac-ft/ac)
1978	30.97	26,410	83,619	57,209	217%	0	26,410	0.785
1979	37.50	40,844	101,250	60,406	148%	35,354	5,490	0.163
1980	27.38	18,768	73,926	55,158	294%	0	18,768	0.558
1981	45.73	53,832	123,471	69,639	129%	46,689	7,143	0.212
1982	26.63	16,715	71,901	55,186	330%	0	16,715	0.497
1983	33.98	22,009	91,746	69,737	317%	14,157	7,852	0.233
1984	26.30	16,057	71,010	54,953	342%	0	16,057	0.477
1985	32.49	23,291	87,723	64,432	277%	10,811	12,480	0.371
1986	35.01	29,704	94,527	64,823	218%	19,300	10,404	0.309
1987	36.66	31,495	98,982	67,487	214%	30,546	949	0.028
1988	19.21	10,735	51,867	41,132	383%	0	10,735	0.319
1989	25.87	18,056	69,849	51,793	287%	0	18,056	0.536
1990	28.44	23,733	76,788	53,055	224%	0	23,733	0.705
1991	52.21	53,733	140,967	87,234	162%	43,864	9,869	0.293
1992	46.05	37,220	124,335	87,115	234%	50,403	(13,183)	(0.392)
1993	26.50	18,187	71,550	53,363	293%	19,072	(885)	(0.026)
1994	41.16	41,439	111,132	69,693	168%	18,279	23,160	0.688
1995	34.04	30,219	91,908	61,689	204%	25,839	4,380	0.130
1996	29.56	21,082	79,812	58,730	279%	2,281	18,801	0.559
1997	47.06	40,328	127,062	86,734	215%	52,170	(11,842)	(0.352)
Averages	34.14	28,693	92,171	63,478	247%	18,438	10,255	0.305

Net increase in runoff = Total Roof Runoff - Native Site Runoff
 Net loss of runoff = Native Site Runoff - Cistern Overflow

Table 6: Hydrologic Analysis of Roofprint Area, CN = 84.

Hydrologic Analysis of Roofprint Area Only

Native Site CN = 84

Pasture or range, Group D soils, Fair condition

Input Parameters

RWH System Configuration			Interior Water Use		
Roofprint area =	4,500	sq. ft.	Occupancy =	4	persons
Cistern volume =	35,000	gallons	Usage Rate =	50	gpcd
Native Site CN =	84		Daily water use =	200	gallons
S-value =	1.905				

Year	Rainfall in Year (in.)	Native Site Runoff (gal)	Total Roof Runoff (gal)	Net Increase in Runoff (gal)	% Increase in Runoff	Cistern Overflow (gal)	Net Loss of Runoff (gal)	Net Loss (ac-ft/ac)
1978	30.97	17,845	83,619	65,774	369%	0	17,845	0.530
1979	37.50	30,966	101,250	70,284	227%	35,354	(4,388)	(0.130)
1980	27.38	11,743	73,926	62,183	530%	0	11,743	0.349
1981	45.73	41,664	123,471	81,807	196%	46,689	(5,025)	(0.149)
1982	26.63	10,722	71,901	61,179	571%	0	10,722	0.319
1983	33.98	12,487	91,746	79,259	635%	14,157	(1,670)	(0.050)
1984	26.30	9,345	71,010	61,665	660%	0	9,345	0.278
1985	32.49	15,134	87,723	72,589	480%	10,811	4,323	0.128
1986	35.01	20,256	94,527	74,271	367%	19,300	956	0.028
1987	36.66	21,446	98,982	77,536	362%	30,546	(9,100)	(0.270)
1988	19.21	5,990	51,867	45,877	766%	0	5,990	0.178
1989	25.87	10,615	69,849	59,234	558%	0	10,615	0.315
1990	28.44	16,023	76,788	60,765	379%	0	16,023	0.476
1991	52.21	38,638	140,967	102,329	265%	43,864	(5,226)	(0.155)
1992	46.05	23,302	124,335	101,033	434%	50,403	(27,101)	(0.805)
1993	26.50	11,161	71,550	60,389	541%	19,072	(7,911)	(0.235)
1994	41.16	30,463	111,132	80,669	265%	18,279	12,184	0.362
1995	34.04	20,192	91,908	71,716	355%	25,839	(5,647)	(0.168)
1996	29.56	12,401	79,812	67,411	544%	2,281	10,120	0.301
1997	47.06	26,561	127,062	100,501	378%	52,170	(25,609)	(0.761)
Averages	34.14	19,348	92,171	72,824	444%	18,438	909	0.027

Net increase in runoff = Total Roof Runoff - Native Site Runoff

Net loss of runoff = Native Site Runoff - Cistern Overflow

Table 7: Hydrologic Analysis of Roofprint Area, CN = 79.

Hydrologic Analysis of Roofprint Area Only

Native Site CN = 79

Pasture or range, Group C soils, Fair condition

Input Parameters

RWH System Configuration			Interior Water Use		
Roofprint area =	4,500	sq. ft.	Occupancy =	4	persons
Cistern volume =	35,000	gallons	Usage Rate =	50	gpcd
Native Site CN =	79		Daily water use =	200	gallons
S-value =	2.658				

Year	Rainfall in Year (in.)	Native Site Runoff (gal)	Total Roof Runoff (gal)	Net Increase in Runoff (gal)	% Increase in Runoff	Cistern Overflow (gal)	Net Loss of Runoff (gal)	Net Loss (ac-ft/ac)
1978	30.97	12,188	83,619	71,431	586%	0	12,188	0.362
1979	37.50	24,003	101,250	77,247	322%	35,354	(11,351)	(0.337)
1980	27.38	7,317	73,926	66,609	910%	0	7,317	0.217
1981	45.73	32,660	123,471	90,811	278%	46,689	(14,029)	(0.417)
1982	26.63	7,105	71,901	64,796	912%	0	7,105	0.211
1983	33.98	6,791	91,746	84,955	1251%	14,157	(7,366)	(0.219)
1984	26.30	5,337	71,010	65,673	1231%	0	5,337	0.159
1985	32.49	9,933	87,723	77,790	783%	10,811	(878)	(0.026)
1986	35.01	13,975	94,527	80,552	576%	19,300	(5,325)	(0.158)
1987	36.66	14,832	98,982	84,150	567%	30,546	(15,714)	(0.467)
1988	19.21	3,257	51,867	48,610	1492%	0	3,257	0.097
1989	25.87	5,976	69,849	63,873	1069%	0	5,976	0.178
1990	28.44	10,876	76,788	65,912	606%	0	10,876	0.323
1991	52.21	28,000	140,967	112,967	403%	43,864	(15,864)	(0.471)
1992	46.05	14,456	124,335	109,879	760%	50,403	(35,947)	(1.068)
1993	26.50	6,783	71,550	64,767	955%	19,072	(12,289)	(0.365)
1994	41.16	22,867	111,132	88,265	386%	18,279	4,588	0.136
1995	34.04	13,464	91,908	78,444	583%	25,839	(12,375)	(0.368)
1996	29.56	7,176	79,812	72,636	1012%	2,281	4,895	0.145
1997	47.06	17,600	127,062	109,462	622%	52,170	(34,570)	(1.027)
Averages	34.14	13,230	92,171	78,941	765%	18,438	(5,208)	(0.155)

Net increase in runoff = Total Roof Runoff - Native Site Runoff

Net loss of runoff = Native Site Runoff - Cistern Overflow

Table 8: Hydrologic Analysis of Roofprint Area, CN = 74.

Hydrologic Analysis of Roofprint Area Only

Native Site CN = 74

Pasture or range, Group C soils, Good condition

Input Parameters

RWH System Configuration			Interior Water Use		
Roofprint area =	4,500	sq. ft.	Occupancy =	4	persons
Cistern volume =	35,000	gallons	Usage Rate =	50	gpcd
Native Site CN =	74		Daily water use =	200	gallons
S-value =	3.514				

Year	Rainfall in Year (in.)	Native Site Runoff (gal)	Total Roof Runoff (gal)	Net Increase in Runoff (gal)	% Increase in Runoff	Cistern Overflow (gal)	Net Loss of Runoff (gal)	Net Loss (ac-ft/ac)
1978	30.97	8,250	83,619	75,369	914%	0	8,250	0.245
1979	37.50	18,813	101,250	82,437	438%	35,354	(16,541)	(0.491)
1980	27.38	4,433	73,926	69,493	1568%	0	4,433	0.132
1981	45.73	25,619	123,471	97,852	382%	46,689	(21,070)	(0.626)
1982	26.63	4,745	71,901	67,156	1415%	0	4,745	0.141
1983	33.98	3,465	91,746	88,281	2548%	14,157	(10,692)	(0.318)
1984	26.30	2,851	71,010	68,159	2391%	0	2,851	0.085
1985	32.49	6,441	87,723	81,282	1262%	10,811	(4,370)	(0.130)
1986	35.01	9,629	94,527	84,898	882%	19,300	(9,671)	(0.287)
1987	36.66	10,355	98,982	88,627	856%	30,546	(20,191)	(0.600)
1988	19.21	1,660	51,867	50,207	3024%	0	1,660	0.049
1989	25.87	3,047	69,849	66,802	2193%	0	3,047	0.091
1990	28.44	7,270	76,788	69,518	956%	0	7,270	0.216
1991	52.21	20,207	140,967	120,760	598%	43,864	(23,657)	(0.703)
1992	46.05	8,693	124,335	115,642	1330%	50,403	(41,710)	(1.239)
1993	26.50	3,985	71,550	67,565	1695%	19,072	(15,087)	(0.448)
1994	41.16	17,255	111,132	93,877	544%	18,279	(1,024)	(0.030)
1995	34.04	8,719	91,908	83,189	954%	25,839	(17,120)	(0.509)
1996	29.56	3,979	79,812	75,833	1906%	2,281	1,698	0.050
1997	47.06	11,464	127,062	115,598	1008%	52,170	(40,706)	(1.209)
Averages	34.14	9,044	92,171	83,127	1343%	18,438	(9,394)	(0.279)

Net increase in runoff = Total Roof Runoff - Native Site Runoff

Net loss of runoff = Native Site Runoff - Cistern Overflow

Without RWH being practiced, of course the runoff would have increased above that from the native site, due to the placement of impervious surfaces on the land, increasing to an average annual flow of 146.04 ac-ft. This is an increase in the 20 year average of 6.34 ac-ft – a change of 0.039 ac-ft/acre/year – or 4.9%. The largest increase in any one year would have been 9.88 ac-ft, or 0.060 ac-ft/acre. The largest annual percentage increase in runoff would have been 6.5%. Compared to the runoff that would have been generated by this development with RWH being practiced, the increase in runoff would have been an average of 8.03 ac-ft/year, or 0.049 ac-ft/acre/year over the 164-acre development. This is an increase of 6.9%. Comparing this to the 6.5% increase in runoff that development at this intensity would impart, this indicates that, on average, practicing rainwater harvesting would actually *restore* the hydrologic integrity of the watershed, in regard to the overall rainfall-runoff response.

Table 10 displays the analysis if the native site CN were 84 – Group D soils in fair hydrologic condition. As noted, this is likely to be a more common condition of land in the Hill Country. In

this case, the native site runoff would have been somewhat lower, averaging 94.22 ac-ft/year over the 20 years covered by the analysis. Practicing RWH would have resulted in a decrease in runoff from the post-development site relative to the native site in only 4 of the 20 years covered by the analysis. The 20-year average runoff would have been 97.72 ac-ft/year, an increase of 3.50 ac-ft/year – 0.021 ac-ft/acre/year – or 3.2%. The greatest reduction in runoff would have been 1.08 ac-ft, or 0.011 ac-ft/acre over this 164-acre development, and a decrease of only 1.2% in that year.

In this case, the runoff from the development without RWH being practiced would have averaged 103.57 ac-ft/year, an average increase relative to native site runoff of 9.34 ac-ft/year – a change of 0.057 ac-ft/acre/year – or 11.0% increase. Compared to the runoff that would have been generated had RWH been practiced, the increase would have been 7.7%. The 20-year average magnitude would have been 5.85 ac-ft/year, or 0.036 ac-ft/acre/year. While the percentage change would have increased from the previous case, the magnitude of the difference in average runoff would have decreased. This is due to the lower CN of the project, in turn due to the lower CN of the native site.

Table 11 shows the analysis with a native site CN = 79 – Group C soils in fair hydrologic condition. In this case, the native site runoff would have been reduced to an average of 64.45 ac-ft/year, while the average runoff from the developed site with RWH being practiced would have been 70.46 ac-ft/ year. This is an increase post-development of 6.02 ac-ft/year – a change of 0.037 ac-ft/acre/year – and an increase of 9.4%. In no year would there have been a net loss of runoff relative to the native site condition, and in some years there would have been sizeable increases post-development, up to a maximum of 22.5%.

Post-development runoff without RWH being practiced would have averaged 74.46 ac-ft/year. This would have been an average increase of 10.02 ac-ft/year – a change of 0.061 ac-ft/acre/year, or an 18.2% increase. The maximum increase in any one year would have been in excess of 27%. Relative to the runoff that would have occurred with RWH being practiced, this would have been an average increase of 4.00 ac-ft/year – 0.024 ac-ft/acre/year – or 8.3%. Again, the percentage increased while the magnitude decreased, due to the lower overall CN.

In Table 12, the analysis is shown for the case with native site CN = 74 – Group C soils in good hydrologic condition. In this case, the native site 20-year average annual runoff drops to 44.06 ac-ft/ year, while the average post-development runoff with RWH being practiced would have been 51.26 ac-ft/year. This is an average increase of 7.19 ac-ft/year, a 17.9% increase, or a unit change of 0.044 ac-ft/acre/year. There would have been an increase in runoff relative to the native site in every year, with an increase of over 35% in 3 of the years. Not only would the practice of RWH not have reduced available runoff in this case, it would have been advisable to install devices such as rain gardens to retain even more runoff on the land than would have been sequestered in the rainwater cisterns.

In this case, the increase of runoff post-development without RWH being practiced would have been 27.5%, but the average magnitude would have been 9.64 ac-ft/year, or 0.059 ac-ft/acre/year, slightly less than the previous case. Compared to the post-development runoff with RWH being practiced, the average percentage change would have risen to 8.7%, but the average magnitude would have dropped to 2.45 ac-ft/year, continuing the trend.

These same patterns are repeated in a development that would have ~15% impervious cover, shown in Tables 13-16, in a development that would have ~20% impervious cover (Tables 17-

20) and in a development that would have ~25% impervious cover, displayed in the remaining tables in this section. As noted previously, the increasing impervious cover percentage was imparted by reducing the total development size and leaving the other parameters the same, except for shortening the roadway lengths. So the magnitude of runoff decreases, since the project area decreases, but all the same patterns of relative changes, detailed above for the case with ~10% impervious cover, are observed in each of these cases.

In all cases, only if the native site was in a poor hydrologic condition and dominated by Group D soils would there have been a consistent decrease in runoff from the post-development site with RWH being practiced relative to the native site. As the impervious coverage of the development increases, the percentage changes in runoff post-development increase. However, the absolute magnitudes of the differences decrease, again because the project areas generating runoff decrease, except for this case of Group D soils in poor hydrologic condition. In that case, the negative magnitude of the difference increases with increasing impervious coverage. In any case, again, the overall patterns hold.

Table 9: Project Scale Hydrologic Analysis, Native Site CN=89 (corresponds with Table N1, Appendix N).

Impervious Cover	10%	Soil Condition	poor	Type	pasture/range	Soil Group	D		
Average (1978-1997)									
Annual Rainfall (in.)	Native Site Runoff (in.)	Developed Project w/ RHW (ac-ft)	Change in Runoff (ac-ft)	Change in Runoff (%)	Developed Project w/out RHW (ac-ft)	Change in Runoff (ac-ft)	Change in Runoff (%)	Change in Runoff, Developed Site (ac-ft)	Change in Runoff, Developed Site (%)
34.14	139.69	138.01	-1.69	-1.8	146.04	6.34	4.9	8.03	6.9

Table 10: Project Scale Hydrologic Analysis, Native Site CN=84 (corresponds with Table N2, Appendix N).

Impervious Cover	10%	Soil Condition	fair	Type	pasture/range	Soil Group	D		
Average (1978-1997)									
Annual Rainfall (in.)	Native Site Runoff (in.)	Developed Project w/ RHW (ac-ft)	Change in Runoff (ac-ft)	Change in Runoff (%)	Developed Project w/out RHW (ac-ft)	Change in Runoff (ac-ft)	Change in Runoff (%)	Change in Runoff, Developed Site (ac-ft)	Change in Runoff, Developed Site (%)
34.14	94.22	97.72	3.5	3.2	103.57	9.34	11	5.85	7.7

Table 11: Project Scale Hydrologic Analysis I With and Without Rainwater Harvesting, Native Site CN=79 (corresponds with Table N3, Appendix N).

Impervious Cover	10%	Soil Condition	fair	Type	pasture/range	Soil Group	C		
Average (1978-1997)									
Annual Rainfall (in.)	Native Site Runoff (in.)	Developed Project w/ RHW (ac-ft)	Change in Runoff (ac-ft)	Change in Runoff (%)	Developed Project w/out RHW (ac-ft)	Change in Runoff (ac-ft)	Change in Runoff (%)	Change in Runoff, Developed Site (ac-ft)	Change in Runoff, Developed Site (%)
34.14	64.45	70.46	6.02	9.4	74.46	10.02	18.2	4	8.3

Table 12: Project Scale Hydrologic Analysis I With and Without Rainwater Harvesting, Native Site CN=74 (corresponds with Table N4, Appendix N).

Impervious Cover	10%	Soil Condition	good	Type	pasture/range	Soil Group	C		
Average (1978-1997)									
Annual Rainfall (in.)	Native Site Runoff (in.)	Developed Project w/ RHW (ac-ft)	Change in Runoff (ac-ft)	Change in Runoff (%)	Developed Project w/out RHW (ac-ft)	Change in Runoff (ac-ft)	Change in Runoff (%)	Change in Runoff, Developed Site (ac-ft)	Change in Runoff, Developed Site (%)
34.14	44.06	51.26	7.19	17.9	53.71	9.64	27.5	2.45	8.7

Table 13: Project Scale Hydrologic Analysis I With and Without Rainwater Harvesting, Native Site CN=89 (corresponds with Table N5, Appendix N).

Impervious Cover	15%	Soil Condition	poor	Type	pasture/range	Soil Group	D			
Average (1978-1997)										
Annual Rainfall (in.)	Native Site Runoff (in.)	Developed Project w/ RHW (ac-ft)	Change in Runoff (ac-ft)	Change in Runoff (%)	Developed Project w/out RHW (ac-ft)	Change in Runoff (ac-ft)	Change in Runoff (%)	Change in Runoff, Developed Site (ac-ft)	Change in Runoff, Developed Site (%)	
34.14	89.44	86.59	-2.85	-4.2	94.63	5.19	6.2	8.04	11.1	

Table 14: Project Scale Hydrologic Analysis I With and Without Rainwater Harvesting, Native Site CN=84 (corresponds with Table N6, Appendix N).

Impervious Cover	15%	Soil Condition	fair	Type	pasture/range	Soil Group	D			
Average (1978-1997)										
Annual Rainfall (in.)	Native Site Runoff (in.)	Developed Project w/ RHW (ac-ft)	Change in Runoff (ac-ft)	Change in Runoff (%)	Developed Project w/out RHW (ac-ft)	Change in Runoff (ac-ft)	Change in Runoff (%)	Change in Runoff, Developed Site (ac-ft)	Change in Runoff, Developed Site (%)	
34.14	60.32	62.66	2.33	2.9	68.62	8.29	15.3	5.96	12.4	

Table 15: Project Scale Hydrologic Analysis II With and Without Rainwater Harvesting, Native Site CN=79 (corresponds with Table N7, Appendix N).

Impervious Cover	15%	Soil Condition	fair	Type	pasture/range	Soil Group	C			
Average (1978-1997)										
Annual Rainfall (in.)	Native Site Runoff (in.)	Developed Project w/ RHW (ac-ft)	Change in Runoff (ac-ft)	Change in Runoff (%)	Developed Project w/out RHW (ac-ft)	Change in Runoff (ac-ft)	Change in Runoff (%)	Change in Runoff, Developed Site (ac-ft)	Change in Runoff, Developed Site (%)	
34.14	41.26	46.22	4.96	11.7	50.41	9.15	26	4.2	13.5	

Table 16: Project Scale Hydrologic Analysis II With and Without Rainwater Harvesting, Native Site CN=74 (corresponds with Table N8, Appendix N).

Impervious Cover	15%	Soil Condition	good	Type	pasture/range	Soil Group	C			
Average (1978-1997)										
Annual Rainfall (in.)	Native Site Runoff (in.)	Developed Project w/ RHW (ac-ft)	Change in Runoff (ac-ft)	Change in Runoff (%)	Developed Project w/out RHW (ac-ft)	Change in Runoff (ac-ft)	Change in Runoff (%)	Change in Runoff, Developed Site (ac-ft)	Change in Runoff, Developed Site (%)	
34.14	28.21	34.49	6.28	23.9	37.19	8.97	40.2	2.69	14.3	

Table 17: Project Scale Hydrologic Analysis II With and Without Rainwater Harvesting, Native Site CN=89 (corresponds with Table N9, Appendix N).

Impervious Cover	20%	Soil Condition	poor	Type	pasture/range	Soil Group	D			
Average (1978-1997)										
Annual Rainfall (in.)	Native Site Runoff (in.)	Developed Project w/ RHW (ac-ft)	Change in Runoff (ac-ft)	Change in Runoff (%)	Developed Project w/out RHW (ac-ft)	Change in Runoff (ac-ft)	Change in Runoff (%)	Change in Runoff, Developed Site (ac-ft)	Change in Runoff, Developed Site (%)	
34.14	63.88	60.29	-3.59	-7.1	68.32	4.44	7.5	8.03	16.2	

Table 18: Project Scale Hydrologic Analysis II With and Without Rainwater Harvesting, Native Site CN=84 (corresponds with Table N10, Appendix N).

Impervious Cover	20%	Soil Condition	fair	Type	pasture/range	Soil Group	D			
Average (1978-1997)										
Annual Rainfall (in.)	Native Site Runoff (in.)	Developed Project w/ RHW (ac-ft)	Change in Runoff (ac-ft)	Change in Runoff (%)	Developed Project w/out RHW (ac-ft)	Change in Runoff (ac-ft)	Change in Runoff (%)	Change in Runoff, Developed Site (ac-ft)	Change in Runoff, Developed Site (%)	
34.14	43.09	44.66	1.57	2.1	50.73	7.64	19.8	6.08	18.1	

Table 19: Project Scale Hydrologic Analysis III With and Without Rainwater Harvesting, Native Site CN=79 (corresponds with Table N11, Appendix N).

Impervious Cover	20%	Soil Condition	fair	Type	pasture/range	Soil Group	C			
Average (1978-1997)										
Annual Rainfall (in.)	Native Site Runoff (in.)	Developed Project w/ RHW (ac-ft)	Change in Runoff (ac-ft)	Change in Runoff (%)	Developed Project w/out RHW (ac-ft)	Change in Runoff (ac-ft)	Change in Runoff (%)	Change in Runoff, Developed Site (ac-ft)	Change in Runoff, Developed Site (%)	
34.14	29.47	33.74	4.27	13.6	38.13	8.66	34.5	4.39	19.7	

Table 20: Project Scale Hydrologic Analysis III With and Without Rainwater Harvesting, Native Site CN=74 (corresponds with Table N12, Appendix N).

Impervious Cover	20%	Soil Condition	good	Type	pasture/range	Soil Group	C		
Average (1978-1997)									
Annual Rainfall (in.)	Native Site Runoff (in.)	Developed Project w/ RHW (ac-ft)	Change in Runoff (ac-ft)	Change in Runoff (%)	Developed Project w/out RHW (ac-ft)	Change in Runoff (ac-ft)	Change in Runoff (%)	Change in Runoff, Developed Site (ac-ft) (%)	
34.14	20.15	25.84	5.69	29.9	28.79	8.64	54.6	2.95	21.2

Table 21: Project Scale Hydrologic Analysis III With and Without Rainwater Harvesting, Native Site CN=89 (corresponds with Table N13, Appendix N).

Impervious Cover	25%	Soil Condition	poor	Type	pasture/range	Soil Group	D		
Average (1978-1997)									
Annual Rainfall (in.)	Native Site Runoff (in.)	Developed Project w/ RHW (ac-ft)	Change in Runoff (ac-ft)	Change in Runoff (%)	Developed Project w/out RHW (ac-ft)	Change in Runoff (ac-ft)	Change in Runoff (%)	Change in Runoff, Developed Site (ac-ft) (%)	
34.14	45.15	40.84	-4.31	-11.8	48.82	3.68	8.8	7.99	24.4

Table 22: Project Scale Hydrologic Analysis III With and Without Rainwater Harvesting, Native Site CN=84 (corresponds with Table N14, Appendix N).

Impervious Cover	25%	Soil Condition	fair	Type	pasture/range	Soil Group	D		
Average (1978-1997)									
Annual Rainfall (in.)	Native Site Runoff (in.)	Developed Project w/ RHW (ac-ft)	Change in Runoff (ac-ft)	Change in Runoff (%)	Developed Project w/out RHW (ac-ft)	Change in Runoff (ac-ft)	Change in Runoff (%)	Change in Runoff, Developed Site (ac-ft) (%)	
34.14	30.45	31.25	0.8	0.2	37.45	7	25.7	6.2	27.2

Table 23: Project Scale Hydrologic Analysis IV With and Without Rainwater Harvesting, Native Site CN=79 (corresponds with Table N15, Appendix N).

Impervious Cover	25%	Soil Condition	fair	Type	pasture/range	Soil Group	C		
Average (1978-1997)									
Annual Rainfall (in.)	Native Site Runoff (in.)	Developed Project w/ RHW (ac-ft)	Change in Runoff (ac-ft)	Change in Runoff (%)	Developed Project w/out RHW (ac-ft)	Change in Runoff (ac-ft)	Change in Runoff (%)	Change in Runoff, Developed Site (ac-ft) (%)	
34.14	20.83	24.39	3.57	15.3	29.03	8.21	46.5	4.64	29.8

Table 24: Project Scale Hydrologic Analysis IV With and Without Rainwater Harvesting, Native Site CN=74 (corresponds with Table N16, Appendix N).

Impervious Cover	25%	Soil Condition	good	Type	pasture/range	Soil Group	C		
Average (1978-1997)									
Annual Rainfall (in.)	Native Site Runoff (in.)	Developed Project w/ RHW (ac-ft)	Change in Runoff (ac-ft)	Change in Runoff (%)	Developed Project w/out RHW (ac-ft)	Change in Runoff (ac-ft)	Change in Runoff (%)	Change in Runoff, Developed Site (ac-ft) (%)	
34.14	14.24	19.33	5.09	37.1	22.62	8.38	75.5	3.29	32.6

Additional Modeling

The preceding provided preliminary analyses determining if any significant reductions in runoff or instream flow would result from the introduction of subdivision scale rainwater harvesting systems in typical Central Texas watersheds. Findings from this modeling show that, except in the case where the watershed is already quite hydrologically degraded, there would be no decrease in the quantities of runoff that might feed stream flows and recharge aquifers if rainwater harvesting at a subdivision wide scale were to occur. An alternate modeling exercise was performed to substantiate these results using more complex modeling software. Two sub-watersheds in the Cypress Creek Watershed were used to examine potential streamflow under various conditions: undeveloped, traditional development and development with the whole subdivision practicing residential-scale rainwater harvesting.

The Hydrological Simulation Program—Fortran (HSPF) water model was used to assist in determining if subdivision wide rainwater harvesting can potentially affect instream flows. HSPF simulates hydrologic and associated water quality processes on pervious and impervious land

surfaces and in streams and well-mixed impoundments, using continuous rainfall to calculate streamflow hydrographs. Three scenarios were set up to compare simulated instream flows for (1) existing conditions, (2) with a model subdivision overlaid, and (3) the model subdivision with rainwater harvesting. The following section reviews the software used and scenarios explored to determine the expected effects of residential-scale rainwater harvesting in sections of the Cypress Creek Watershed.

Software

BASINS (Better Assessment Science Integrating point and Nonpoint Sources) is a multipurpose environmental analysis system designed for use by regional, state, and local agencies in performing watershed and water quality-based studies (EPA BASINS). BASINS is used to download and view the data necessary to run the water model. HSPF, mentioned above is a comprehensive package for simulation of watershed hydrology and water quality for both conventional and toxic organic pollutants (EPA HSPF). HSPF was used to simulate instream flows based on observed precipitation, shown in Table 25, for the scenarios used in this analysis. The Generation of Model Simulation Scenarios for Watersheds (GenScn) was used to display simulation results, shown in Figure 6.

Methodology

For the preliminary analysis, the Cypress Creek watershed was broken up into 9 subbasins by the HSPF, illustrated in Figure 7. The specific study-subdivision was located in subbasin 8 and flows from subbasin 9 were used. Three scenarios were set up to determine if instream flows could be affected by the addition of an 82 home subdivision with a combined roof print of 369,000 ft² (8.5 acres). Scenario 1 looks at existing conditions, scenario 2 looks at flows with an added subdivision and scenario 3 adds a component to scenario 2 that accounts for the rainwater harvesting system. It is assumed that the cisterns on the 82 homes are empty in scenario 3. HSPF simulated flows for scenarios 1 and 2 to determine how much instream flows increased with the added subdivision, with the results displayed in Table 26.

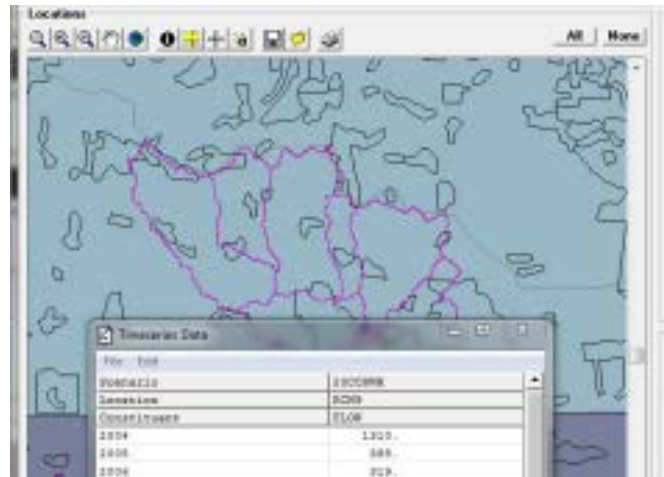
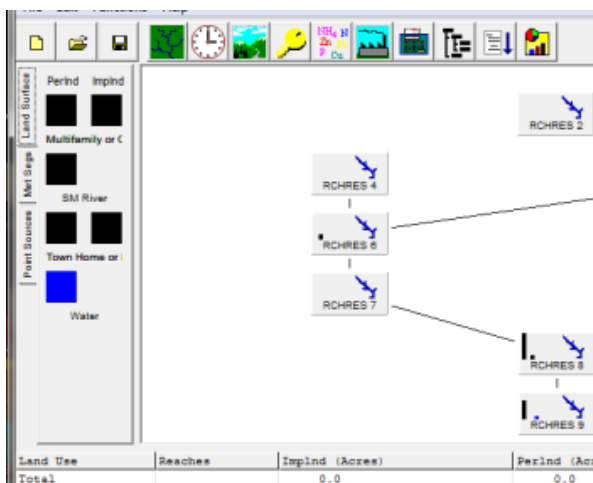
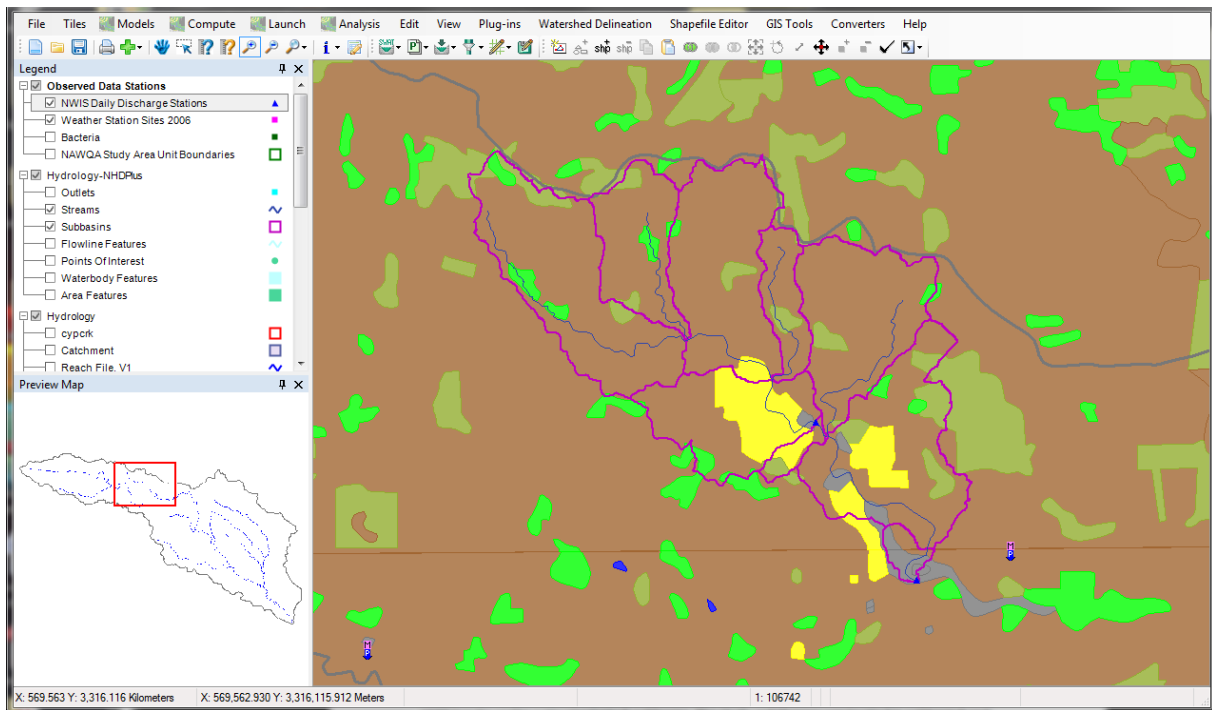

Figure 6: Basins, HSPF and GenScn Results.

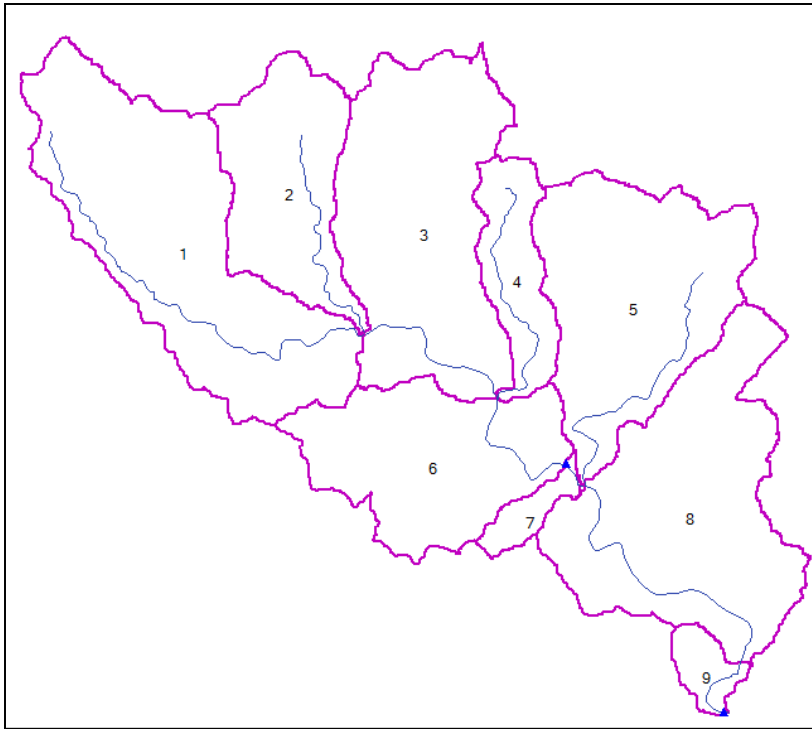

Figure 7: Cypress Creek Watershed and Subwatersheds Used in Modeling.

Table 25: Observed Total Precipitation for the Cypress Creek/Wimberley Weather Station.

Weather Station	2004 Precipitation	2005 Precipitation	2006 Precipitation
Wimberley 1 NW, TX 419815	60.5 in.	20.1 in.	24.6 in.

Table 26: Simulated Flows in Cubic Feet per Second (CFS).

Scenario	2004 Flow, CFS	2005 Flow, CFS	2006 Flow, CFS
1.Existing	1030	299	243
2. Existing + study subdivision	1310	388	319
Percent increase	12%	13%	14%

Results

As displayed in Table 26, flows increase by approximately 12% in all years when the impervious cover/development of the study subdivision are added to existing conditions. Modeled flows in all 3 years shows very little change in potential flow when rainwater is harvested for the entire model subdivision. It is observed that with the addition of a rainwater harvesting system to the model subdivision, flows are not reduced to predevelopment levels, much less to a level below them. These results show that steamflow will not be reduced if subdivisions relying on rainwater harvesting were to be installed in the watershed.

Furthermore, the increased flows from new development in the watershed will carry increased amounts of non-point source pollution into the river. Rainwater harvesting systems may reduce the amount of non-point source pollution entering rivers. Future studies of a subdivision relying on rainwater harvesting will be able to utilize HSPF for all three scenarios and may account for the amount of water in the tanks after each precipitation event.

Table 27: Calculated Flows for Scenarios in Cubic Feet per Second (CFS).

Scenario	2004 Flows, CFS	2005 Flows, CFS	2006 Flows, CFS
1. Existing	52,029.5	17,285.8	21,155.8
2. Existing + study subdivision	58,273.1	19,533	24,117.6
3. Existing + study subdivision - rainwater harvesting system	58,111.4	19,479.3	24,052

Summary and Conclusions for Hydrologic Impact Assessment

These analyses indicate that, unless the native site condition is quite hydrologically degraded, using residential-scale rainwater harvesting as a development-wide water supply strategy would not result in a net loss of runoff over the watershed, even if whole watersheds were to be rather intensively developed using that strategy. In developments with higher impervious cover, the analyses indicate it would be necessary to install devices such as rain gardens to hold runoff on the land in order *not* to hydrologically degrade the watershed by significantly *increasing* the runoff induced by development. In that case, the practice of residential-scale rainwater harvesting would *decrease* the magnitude of that problem.

In any case, it is clear that *any water gathered in a rainwater cistern does not exit the watershed*. Rather, this water is used in the building and then would be dispersed, through a wastewater system. That water would flow directly out of the watershed only if the wastewater system effluent were directly discharged to a stream. Even in that case, this would be a more steady flow than stormwater runoff, so it would enhance baseflow at the expense of quickflow. If the wastewater were dispersed into the soil, it would either evapotranspire or percolate through the soil, perhaps to contribute to baseflow in streams or recharge to aquifers.

This being the case, it can be argued that broadscale practice of rainwater harvesting, even at a fairly high development density, would improve a watershed which is in a badly hydrologically degraded condition. The harvested rainwater would be withheld from the flash hydrology which is exacerbated by the degraded condition of the watershed. Any of this water which became effluent that then percolated, or was discharged, to augment baseflow instead of flashing off the land would improve the overall hydrologic condition of the watershed. Routing this water to augmentation of baseflow rather than immediately running off as quickflow may actually improve the ability of downstream users to obtain a consistent water supply. Also, presuming wastewater management practices were sensitive to the receiving environment, any areas that might be irrigated with the treated wastewater would provide hydrologically improved surfaces, and these would help to restore the hydrologic integrity of that little part of the watershed.

The conclusion from these analyses is that *the broadscale practice of residential-scale rainwater harvesting would not hydrologically degrade a watershed*. Indeed, in most cases, it appears that rainwater harvesting would actually blunt the degradation of watershed hydrology imparted by development. It would do this by reducing the amount of increased runoff induced by development, by sequestering some of that runoff in the rainwater cistern, to be later dispersed into the watershed through the wastewater system.

Admittedly, the models used to conduct the first set of analyses were fairly crude. Although the second modeling exercise was only performed in one small portion of the Hill Country, its results confirm the conclusions that subdivision-scale rainwater harvesting systems would not negatively affect streamflow, would not create significant runoff changes (when compared to traditional development) and may possibly improve water quality by slowing some of the runoff.

VII. Cost Effectiveness Analysis: Residential-scale Rainwater Harvesting vs. Conventional Supply Systems

A prime determinant for selection of a residential-scale rainwater harvesting (RWH) system is its cost compared to the other available water supply options. The conventional options with which the RWH option is compared in this section include:

- A private well serving each house in the development;
- A community well and a water distribution system installed within the development; and
- Extending a waterline from an existing public water supply system and installing a water distribution system within the development.

Sources of Cost Information

For the RWH option, cost information was obtained from four companies that design and install RWH systems. The cost spreadsheet, shown in Table 28, produced on the basis of that input, was offered to each of these companies for review. Based on this feedback and subsequent discussions with developers, it is concluded that the system costs reflected in Table 28 are a fair estimate of costs of the RWH option.

For the private well option, information was obtained from two well-drilling companies and one company that specializes in water treatment. The cost spreadsheet shown in Table 29 was prepared on the basis of the information provided by them.

For the community well option, well costs were obtained from a well-drilling company and from an engineer who prepared cost information and did the planning and design of a project which would rely on a community well for its water supply. The costs for the water distribution system were derived from information provided by another engineer for a proposed development, which would contain 82 lots. While this may or may not be typical of the sort of development that might optionally use the RWH strategy, it does at least provide a point of cost comparison. The water rates for this project were derived from the engineer's estimates of the operating costs of the system from which the well costs were derived. The various costs obtained by these means

are displayed in Table 30, with caveats on their accuracy noted in the margin of the capital cost table.

For the option of extending a waterline from an existing public water supply system, that same 82-lot development was used as a typical example. The actual water supply option proposed for that development was to extend a waterline from the Dripping Springs WSC system, so the costs for this option were derived from the engineer's estimates for that project. The water rates for this option were drawn from the Dripping Springs WSC rate schedule. The costs for this option are shown in Table 31, again with caveats noted in the margin of the capital cost table.

The discount rate of 4.375% used to transform future system O&M costs and water costs into a net present value (NPV) is the official rate used for cost analysis of projects funded by the State of Texas. This rate was obtained from TWDB.

Table 28: Cost of Rainwater Harvesting System.

COSTS OF RWH SYSTEM

INSTALLED CAPITAL COST OF RWH SYSTEM

Cost Item	Quantity	Units	Unit Price	Total Cost	
"Extra" roofprint	1,000	sq. ft	\$ 13	\$ 13,000	discounts other benefits
Cistern	35,000	gal.	\$ 1	\$ 21,000	depends on cistern type
Pump & pressurization system	1	L.S.	\$ 2,500	\$ 2,500	
Cartridge filter system	1	L.S.	\$ 1,000	\$ 1,000	
UV disinfection system	1	L.S.	\$ 1,000	\$ 1,000	
Gutters/First-flush/Rain leaders	1	L.S.	\$ 2,000	\$ 2,000	depends on system lay out
TOTAL INSTALLED SYSTEM COST =				\$ 40,500	

OPERATIONS AND MAINTENANCE COSTS OVER 20-YEAR SERVICE LIFE

		Discount rate =					Total	Year	Total Net
Cost Item	Quantity	Units	Unit Price	Total Cost Basis	Incurred	Present Worth			
	4.375%								
Electricity	1,250	KWH	\$ 0.08	\$ 100.00	All	\$1,328			
General maintenance	2	man-hrs	\$ 50.00	\$ 100.00	All	\$1,328			
Pump replacement	1	L.S.	\$ 500.00	\$ 500.00	10	\$324			
Pump replacement	1	L.S.	\$ 500.00	\$ 500.00	20	\$209			
Filter cartridge replacement	2	L.S.	\$ 100.00	\$ 200.00	All	\$2,657			
UV bulb replacement	1	L.S.	\$ 135.00	\$ 135.00	All	\$1,793			
TOTAL NET PRESENT WORTH OF 20 YEARS O&M =						\$7,640			

TOTAL NET PRESENT WORTH OF INSTALLED SYSTEM + 20 YR O&M =

\$ 48,140

NOTES:

1. No inherent limit on development density due to water availability.
2. The "extra" roofprint can provide benefits of outdoor living space and energy conservation in addition to collection area.
3. Occasional costs for backup water supply may be incurred, depending on future rainfall patterns.

Table 29: Cost of Private Well System.

COSTS OF PRIVATE WELL SYSTEM						
INSTALLED CAPITAL COST OF PRIVATE WELL SYSTEM						
Cost Item	Quantity	Units	Unit Price	Total Cost		
Drill and complete well	1	L.S.	\$ 25,000	\$	25,000	
Pump & pressurization system	1	L.S.	\$ 5,000	\$	5,000	
Water treatment unit	1	L.S.	\$ 3,000	\$	3,000	
Disinfection system	1	L.S.	\$ 2,000	\$	2,000	
TOTAL INSTALLED SYSTEM COST =				\$	35,000	
OPERATIONS AND MAINTENANCE COSTS OVER 20-YEAR SERVICE LIFE						
Discount rate =			4.375%			
Cost Item	Quantity	Units	Unit Price	Total Cost Basis	Year Incurred	Total Net Present Worth
Electricity	2,000	KWH	\$ 0.08	\$ 160.00	All	\$2,125
General maintenance	2	man-hrs	\$ 50.00	\$ 100.00	All	\$1,328
Pump replacement	1	L.S.	\$ 1,000.00	\$ 1,000.00	10	\$647
Pump replacement	1	L.S.	\$ 1,000.00	\$ 1,000.00	20	\$419
Treatment unit maintenance	1	L.S.	\$ 200.00	\$ 200.00	All	\$2,657
Disinfection system maintenance	1	L.S.	\$ 50.00	\$ 50.00	All	\$664
TOTAL NET PRESENT WORTH OF 20 YEARS O&M =						\$7,841
TOTAL NET PRESENT WORTH OF INSTALLED SYSTEM PLUS 20 YEARS O&M =						\$ 42,841
NOTES:						
1. Well permitting cost may also be incurred, depending on the jurisdiction.						
2. Development density may be limited by groundwater availability.						
3. Per well drillers, many houses also install storage tank/booster pump, at ~\$5,000 cost.						

Table 30: Cost of Community Well and Distribution System.

COSTS OF COMMUNITY WELL AND DISTRIBUTION SYSTEM						
Presumed no. of lots in development =		82				
INSTALLED CAPITAL COST OF OVERALL SYSTEM						
Cost Item	Quantity	Units	Unit Price	Total Cost		
Land cost for well site	1	L.S.	\$ 20,000	\$	20,000	
Electrical service to well site	1	L.S.	\$ 8,000	\$	8,000	
Well drilling and completion	1	L.S.	\$ 200,000	\$	200,000	
Water storage tank	16,400	gal.	\$ 2	\$	32,800	
Pump & pressurization system	1	L.S.	\$ 75,000	\$	75,000	
Well water treatment/disinfection	1	L.S.	\$ 25,000	\$	25,000	
Water distribution system	1	L.S.	\$ 465,000	\$	465,000	
House water meter/tap fee	82	each	\$ 1,500	\$	123,000	
TOTAL INSTALLED SYSTEM COST =				\$	948,800	
TOTAL INSTALLED SYSTEM COST PER HOUSE =				\$	11,571	
OPERATIONS AND MAINTENANCE COSTS OVER 20-YEAR SERVICE LIFE						
Discount rate =		4.375%		Total	Year	Total Net
Cost Item	Quantity	Units	Unit Price	Cost Basis	Incurred	Present Worth
Basic service fee	984	payments	\$ 60.00	\$ 59,040.00	All	\$784,258
Water cost above base rate	4100	Kgal.	\$ 6.00	\$ 24,600.00	All	\$326,774
Annual well permit fee	1	L.S.	\$ 2,000.00	\$ 2,000.00	All	\$26,567
TOTAL NET PRESENT WORTH OF 20 YEARS O&M =						\$1,137,599
TOTAL NET PRESENT WORTH OF 20 YEARS O&M PER HOUSE =						\$13,873
TOTAL NET PRESENT WORTH OF INSTALLED SYSTEM PLUS 20 YEARS O&M =						\$2,086,399
TOTAL NET PRESENT WORTH OF INSTALLATION AND O&M PER HOUSE =						\$ 25,444
NOTES:						
1. Water use presumed to be 6,000 gal/month, to match presumed usage rate of RWH system.						
2. Future water price may escalate (without regard to pace of development, simply due water scarcity).						
3. Development density may be limited by groundwater availability.						
4. Except for house water meter/tap fees, installation costs must be expended prior to building the first house.						
5. If pace of development is slower than expected, revenues may not cover operating costs, increasing fees/prices.						

Table 31: Cost of Extending Service from an Existing System.

COSTS OF EXTENDING SERVICE FROM EXISTING SYSTEM

Presumed no. of lots in development = 82

INSTALLED CAPITAL COST OF OVERALL SYSTEM

Cost Item	Quantity	Units	Unit Price	Total Cost	
Land cost for hydro tank/booster pump	1	L.S.	\$ 20,000	\$ 20,000	need depends on water system
Electrical service to booster pump	1	L.S.	\$ 8,000	\$ 8,000	need depends on water system
Water line extension to project site	1	L.S.	\$ 340,000	\$ 340,000	depends on project location
Water impact fee	82	each	\$ 5,250	\$ 430,500	depends on water provider
Booster pump station and hydro tank	1	L.S.	\$ 65,000	\$ 65,000	need depends on water system
Water distribution system	1	L.S.	\$ 465,000	\$ 465,000	depends on project layout
House water meter/tap fee	82	each	\$ 1,250	\$ 102,500	depends on water provider
TOTAL INSTALLED SYSTEM COST =				\$1,431,000	
TOTAL INSTALLED SYSTEM COST PER HOUSE =				\$ 17,451	

OPERATIONS AND MAINTENANCE COSTS OVER 20-YEAR SERVICE LIFE

Cost Item	Quantity	Units	Unit Price	Total Cost Basis	Year Incurred	Total Net Present Worth
Discount rate = 4.375%				Total	Year	Total Net
Basic service fee	984	payments	\$ 35.00	\$ 34,440.00	All	\$457,484
Water cost above base rate	4100	Kgal.	\$ 3.75	\$ 15,375.00	All	\$204,234
TOTAL NET PRESENT WORTH OF 20 YEARS O&M =						\$661,717
TOTAL NET PRESENT WORTH OF 20 YEARS O&M PER HOUSE =						\$8,070

TOTAL NET PRESENT WORTH OF INSTALLED SYSTEM PLUS 20 YEARS O&M = \$2,092,717
TOTAL NET PRESENT WORTH OF INSTALLATION AND O&M PER HOUSE = \$ 25,521

NOTES:

1. Water use rate presumed to be 6,000 gal/month, to match presumed usage rate for RWH system.
2. Future water price may escalate (without regard to pace of development, simply due to water scarcity).
3. Except for house water meter/tap fees, entire capital cost must be expended prior to building the first house.
4. If pace of development is slower than expected, revenues may not cover costs of service.

Review and Discussion of System Costs

The option with the least first cost and essentially tied for the lowest NPV is a community well and water distribution system within the development, the costs for which are shown in Table 30. It is noted that the cost estimates for this option are somewhat speculative, as no examples of a recent development employing this water supply strategy could be located. As noted above, the cost factors were adapted/ estimated from the engineer's estimate for a Hill Country project and a rate structure inferred from the cost estimates for another project proposing to use a community well system. In any case, the cost of the well would depend on the groundwater depth and availability at the project location, and the cost of any treatment/disinfection system would depend on the available water quality. Actual well permit costs would depend on the policies or rules of a groundwater district covering the area where the project was located. The permit cost shown in Table 30 was derived from the engineer's cost estimate used to estimate the well cost.

With those caveats, the capital cost of the community well option calculates out to be about \$11,600 per house in the development, and the NPV of 20 years of well permit fees and water costs calculates out to be about \$13,900 per house. Together these total to an NPV for this water supply option of about \$25,500 per house. Note that all system O&M costs are presumed to be funded by the water rates.

The presumed water usage used to calculate water costs is 6,000 gallons/month. This amount was used to match the presumption of water usage by an RWH system. As reviewed in Section II, the nominal presumption of occupancy is 4 people, and the nominal presumption of per capita usage rate is 50 gallons/day, totaling to 200 gallons/day. Multiplied times 30 days, this yields the total monthly usage of 6,000 gallons. With the users unmotivated by the conservation ethic that would drive users of an RWH system, their usage may be more profligate, and they may also be similarly unmotivated to maximize the beneficial reuse of their wastewater to satisfy irrigation demands, so actual usage by clients of a community well system may be greater. However, presuming this 6,000 gallons/month usage rate puts this option on a more "apples to apples" basis with the RWH option in terms of on-going costs.

An unknown is how much water rates may escalate in the future, which may drive the on-going costs of this water supply option higher. However, a community well system is a self-contained system, and as long as there is water of adequate quality in the aquifer that the well can produce, the costs of running the water system should not be all that prone to inflation.

A much more serious prospect is drawdown/depletion of the aquifer from which the well produces. This may require that the well be deepened, enhanced treatment be provided, or in the worst case, that another source of water supply be acquired. The costs of the latter may be severe. In either case, there may be disruptions in water supply to the houses, perhaps entailing water hauling during an interim period while the well is deepened or an alternate supply is obtained. That circumstance would require each of the house owners to install a holding tank as well, another cost which cannot be evaluated a priori. It may be noted that Hill Country aquifers are being mined – overdrawn, thus depleting the aquifers – even at present levels of development, so that supplying many more developments with a community well system may not be a viable strategy. That will, of course, depend on the specific circumstances of the aquifer and the location in question, and upon the total level of development eventually installed in that area.

In any case, with development depending on local groundwater for water supply, a limitation on development density may be imposed. This may be dictated by a groundwater district, or

through water availability requirements imposed by counties in the platting process. An example is the portion of Hays County in which wells would draw water from the Trinity Aquifer, where a restriction of one house per 6 acres has been established. In such a case, development drawing water supply from wells would be restricted to estate lot sizes, although conservation development may be an option, with houses clustered on smaller lots and the remaining acreage left in conservation easements or in common space.

For this option it is also noted that, except for the house meters/taps fees, the entire cost of the water supply system would have to be paid for in advance of building and serving the first house in the development. In the case represented in Table 30, this is almost a \$1 million cost – as noted above, about \$11,600 per lot – which, in essence, speculates that the lots will sell.

Even more critical in the case of a self-contained community well system, the operations and maintenance of the water system would have to be covered by water rates. If the pace of building were to be slow, there would be fewer customers to cover these costs, which may escalate the rates for the customers who build early in the life of the development. In any case, even at build-out, the water costs reflected cover only routine system O&M and a modest sinking fund for equipment replacement and waterline repairs, according to the calculations of system operating costs provided by the engineer for a proposed community well system. An early failure of a well pump or a spate of waterline breaks might create a rate shock for the customers of such a system.

The system with the next lowest first cost, and essentially the same NPV as the community well system, is extending a waterline from an existing public water supply system and installing a water distribution system within the development. Costs for this option are displayed in Table 31. As noted, the costs for this option were drawn from the engineer's estimate of a proposed development to be served by the Dripping Springs WSC, and the water rates were drawn from that system's rate schedule. For this particular project then, the costs are fairly certain. What cannot be known, however, is how typical these costs may be, as they reflect the particular placement of this project relative to that water supply system, and the particular layout/arrangement of this development.

Given those caveats, the capital cost of this system calculates out to be about \$17,500 per house, and the NPV of the on-going water costs incurred by the users calculates out to be about \$8,100 per house, totaling to an NPV of about \$25,600 per house. In this case also the presumed water usage is 6,000 gallons/month, to put the on-going water costs on an "apples to apples" basis with the expected usage by clients of an RWH system.

In this type of a system, in which the water supply is derived from a reservoir through a regional pipeline system, there may be significant spikes in future water costs, since the water supply source is currently in stress, and continuing to draw ever greater quantities of water supply from it may not be possible. To continue to support growth within the service area of any given water supply system, alternate water sources may have to be tapped. These may entail very costly projects to import water over long distances, such as presently proposed projects to import water into the Hill Country from the Simsboro Aquifer well to the east of this area.

In any case, water rates in this sort of system would likely rise due to inflation, to support rising wages for water system workers, increased costs of vehicles, and increased energy costs to pump water and to run those vehicles. Also, as the system ages, leak repair costs are likely to increase, perhaps entailing some waterline replacement costs. These factors will quite likely increase the

on-going water costs, so that the NPV of 20 years of on-going costs for this option would be greater than shown in Table 31, by an indeterminate amount.

For this option also, except for the house meter/tap fees, all the costs of the water supply system must be paid up front of building and serving the first house in the development. For the system reflected in Table 31, this is a cost of almost \$1.5 million, or about \$17,500 per lot. Again, this essentially speculates that the lots would sell, houses would be built and water use charges would begin to be paid in a timely manner. In this case, since this development would be a client of a much larger system, the consequences to the water system of a slower than anticipated buildout in this small development would be far less significant than it would be for a self-contained community well system.

Since a development served by this sort of water system would not rely on local groundwater, it is unlikely that there would be any inherent limit on development density due to water availability considerations. This might come into play if the water source were a wellfield drawing water from a Hill Country aquifer. However, much of the Hill Country is not served by or within a reasonable waterline extension of an existing public water supply system, so the ability to connect to such a system is a happenstance of project location. Again this highlights that the costs reflected in Table 31 may or may not actually be typical for this water supply strategy.

The water supply option with the next lowest first cost and NPV is a private well to serve each house in a development. This is the typical default strategy in many Hill Country developments. Table 29 shows first cost estimated at \$35,000, which may be significantly impacted by required well depth and the quality of the water which the well produces, as noted in the caveats listed in the margin of the capital cost table. The on-going O&M costs of a private well system per the cost factors in the O&M table yield an NPV of just over \$7,800. Together these costs yield a total NPV for a private well of about \$42,800.

Not included in this evaluation are any costs for a well permit, which may be imposed by a groundwater district. So far, wells of a size that would serve a single home have been deemed to be exempt wells, which remain largely unregulated by groundwater districts. Also unregulated by groundwater districts is well spacing, the surrogate for which is typically minimum lot size. State regulations restrict lot size to one acre or greater when water supply is obtained from a private well and wastewater service is provided by an on-site wastewater system. However, as groundwater districts deal with the implications of continuing development for the desired future conditions set by the state water planning process, the issue of what are supportable lot sizes may well come to the fore.

In any case, as noted in the discussion of a community well system, some jurisdictions already impose minimum lot sizes in recognition of water availability requirements. Again, Hays County is an example, imposing a minimum lot size of 6 acres for developments which would draw water supply from the Trinity Aquifer. In such cases, this restricts the development type to estate lot projects, although again clustering of houses on smaller lots with the remainder of the area left in open space may be an option. Still, such restrictions impose increased land costs in order to develop projects using private wells for water supply.

Another cost not included in Table 29 is a storage tank and booster pump. Well drillers relate that this is an increasingly popular option among people building a home that depends on a well drawing from aquifers in the Hill Country. This is because well yields may be too low to

provide supply on demand, so pumping out of the well into a storage tank to provide surge storage is recommended. As noted in Table 29, a typical cost for this option is about \$5,000. That would drive the capital cost of the private well option to \$40,000 and the NPV to \$47,800. This option would also entail additional power costs, as a second pump system is required to pressurize the water that is stored in the tank, increasing the NPV even more.

The costs of the RWH option, shown in Table 28, indicate the first cost would be about \$40,500, and the NPV of 20 years of O&M costs would be about \$7,600. Together these total to an NPV of about \$48,100. This is in the same ballpark as the private well option. The first cost is \$23-29 thousand more than for the community well or waterline extension options, and about a \$22,600 increase in NPV over each of those options.

As can be seen in the capital cost table, the RWH system first cost is dominated by the costs of extra rooftop and the cistern. The cistern cost is the lowest cost quoted for a free-standing cistern. This price might be reduced by integrating the cistern into the foundation design, but investigations to date cast doubt on that, as such options appear to be more expensive. (Building design issues are a subject of on-going investigation in this project, and is suggested as a topic for continuing work.) It is also noted that the rooftop area and the cistern size are those indicated by the modeling process to be required for essential water independence for 4-person household consuming water at a rate of 50 gallons/person/day – 4,500 ft² of rooftop and a 35,000-gallon cistern. As noted below, a smaller rooftop and/or cistern may be merited if usage rates could be held somewhat below this.

Even at a usage rate of 50 gallons/person/day, however, the modeling indicates that a smaller system would typically incur a significant amount of backup supply only in drought years. The fiscal tradeoff between paying for a larger system up front vs. a smaller system incurring even fairly frequent backup supplies would favor the smaller system, at least at the present prices for backup supply quoted by water haulers. However, as reviewed in Section V, dealing with backup supply strategies, the practical workability of a tanker truck backup supply system may be problematic if hundreds of houses were to employ the RWH strategy with a small system in place. For example, the Dripping Springs RWH model indicates that with a system sized so that minimal extra rooftop would be required and only a 25,000-gallon cistern were installed, 20-30 thousand gallons of backup supply – or about 10-15 truckloads – would have been required for each house over the last 25 years in 1996, 2008, 2009 and 2011.

However, it has been asserted that users of RWH systems typically use water at a rate of around 35 gallons/person/day instead of 50, and cases have been documented of even lower usage rates. Inserting this usage rate into the model of that smaller RWH system, it was observed that backup supply would only have been required in 2011, in the amount of 8,000 gallons, or 4 truckloads. So if indeed RWH system users were to faithfully practice such a conservation ethic, then downsizing the RWH systems may not overly strain a backup supply system.

The practical impacts of this going forward are unknown, of course, as the rainfall patterns are unknowable – although climatologists believe that Central Texas will be drier than normal at least through the current decade – and the number of houses that will employ the RWH strategy, and thus the level of strain on backup supply capacity – and indeed how much additional backup supply capacity can be affordably developed – are also unknown. Therefore, this nominal analysis presumes that 1,000 ft² of extra rooftop must be provided – presuming that a normal design for a house and garage would net about 3,500 ft² of total rooftop, bringing total rooftop area to 4,500 ft² – and that the cistern size would be 35,000 gallons.

Even with these stipulations, it is seen that the RWH strategy does not suffer greatly in comparison with the private well option. Indeed, if a private well system did require the storage tank/booster pump option, the RWH option would have essentially the same first cost and NPV. Given the uncertainties inherent in the various cost factors, these options may be considered to have essentially equivalent life-cycle costs.

However, with the RWH option, there would be no inherent limitation of development density on the basis of water availability considerations. Therefore, in areas such as Hays County where lot sizes with private wells are restricted to 6 acres or greater, the RWH strategy could offer developers somewhat greater lot yield for the same land cost. In jurisdictions with water availability demonstration requirements like Hays County, it is also likely to be a less burdensome process to demonstrate water availability for the RWH option than for the private well option, so this may be another advantage to a developer in setting up and platting a development. In any case, even where there are no requirements to demonstrate water availability – which at present appears to be most of the other Hill Country counties – platting of projects in which RWH systems are presumed to be the water supply appears to be no more burdensome than platting with the presumption that water supply would be provided by private wells.

Then too there are water quality issues with groundwater over much of the Trinity Aquifer area. This not only requires water treatment, and the O&M of that equipment, but still often results in degradation of fixtures and other undesirable consequences for the homeowner. Fixture replacement – e.g., water heaters, toilet valves – is another cost which is not input into this analysis, but is a real cost for many private well users, a cost that would be avoided by RWH system users. This same consideration may apply to a community well system, since the same groundwater would constitute the supply source.

Another inherent advantage of the RWH option is that there is essentially no prospect for water cost increases. Once the system is in place (and assuming that persistent severe drought does not occur, resulting in large backup supply requirements), on-going costs are limited to system O&M – periodic filter cartridge replacement, annual ultraviolet (UV) bulb replacement and pump replacement at intervals expected to be 10 years or so. Inflation may increase the costs of filter cartridges, UV bulbs and pumps, but as noted any such cost increases may pale in comparison to the increased water costs if new supplies must be imported from other areas of the state, which might be required to support continuing development on piped water systems over at least some of the Hill Country.

In that same vein, the mining of Hill Country aquifers, expected to be exacerbated if more and more wells are drilled to serve more and more development, may lead to private wells and/or community wells not being a viable strategy over the long term. Or at least at some point, they may not be able to support any additional development. RWH systems, on the other hand, while vulnerable to severe drought conditions, would not be affected by such eventualities.

From the developer's micro-economic perspective, the RWH strategy is like the private well strategy in that it does not require any significant expenditure by the developer on a water system up front of building and serving the first house. Therefore, the developer does not put a large amount of money at risk installing a water system, which must be completed – and paid for – prior serving that first house. Besides avoiding the commitment of these funds, the developer may also be able to shorten the timeline to being able to sell lots, since the time to design and

install the water system and to get the installation inspected and approved would be obviated. Further, the developer may avoid the costs and time required to establish an operating authority for that state-regulated public water system.

In theory, at least, these savings would be passed on to lot buyers in the form of lower lot costs. This would defray the estimated \$23,000 or \$29,000 in the cost of a house that the RWH system may add. So while the bare cost analysis shows that to be the cost premium that a homebuilder would incur if the developer set up the development with RWH systems as the water supply strategy, that amount may effectively be somewhat less than that, to perhaps a net cost difference of about \$8,000 or \$19,000, as shown in Table 32 for the existing water system extension option and the community well option, respectively.

Summary and Conclusions for Cost Effectiveness

A summary and comparison of the costs of the water supply options evaluated in this report is shown in Table 32. Subject to the many caveats reviewed above, it is concluded that the NPV of an RWH system and a private well are fairly close. However, the RWH option offers advantages in terms of water quality and long-term water security. These options may be viewed as essentially equivalent from the short-term micro-economic perspective of the developer.

Also subject to the caveats reviewed above, the RWH option would have an NPV ~\$23,000 greater than collective water supply system options. As noted, however, the RWH option would avoid any significant up-front costs to install the water system. Those cost savings may show up as lower lot costs, so that the actual increase in NPV may be somewhat lower, as noted above. In this case also, the RWH option may deliver water quality benefits. Additionally, the RWH option would be fairly immune to future water cost increases or supply disruptions, recognizing of course the vulnerability of the RWH option to severe, prolonged drought. However, presuming the continuing availability of backup supplies, even in severe drought some level of supply would be assured.

Table 32: Summary and Comparison of Water Supply Options.

Summary and Comparison of Water Supply Option Costs						
Water Supply Option	Capital Cost per House	NPV of Water/O&M per House	Total NPV per House	RWH "premium" Cap. Cost over option	RWH "premium" NPV over option	
Rainwater Harvesting	\$ 40,500	\$7,640	\$ 48,140			
Private Well	\$ 35,000	\$7,841	\$ 42,841	\$ 5,500		\$ 5,299
Community Well	\$ 11,571	\$13,873	\$ 25,444	\$ 28,929		\$ 22,696
Waterline Extension	\$ 17,451	\$8,070	\$ 25,521	\$ 23,049		\$ 22,619
	Capital Cost "premium"	Avoided Cost of Water System	Estimated Lot Cost Reduction	Net Capital Cost w/ Lot Cost Reduction		
RWH vs. Community Well	\$ 28,929	\$ 11,571	\$ 10,000	\$ 18,929		
RWH vs. Waterline Extension	\$ 23,049	\$ 17,451	\$ 15,000	\$ 8,049		

In conclusion, the RWH strategy might be considered essentially cost-neutral relative to a private well strategy, but would not be considered cost efficient in conventional terms relative to collective water supply system options. Choosing the RWH option over those strategies would

be based on factors other than the apparent raw costs of the options, such as avoiding up-front costs and the location and circumstances of the development in question.

VIII. Review of Marketing Issues and Implications

To gain insight into the issues impacting on marketing of developments which would employ RWH as the sole source of water supply and to gain an appreciation of the implications on marketability, a focus group was assembled in August 2012 (Figure 8). The focus group consisted of the following categories of stakeholders: land developers, homebuilders, architects, land planners and engineers, real estate brokers, a banker (home finance specialist), and consumers (potential home buyers).



Figure 8: Interactive activity with Focus Group Participants.

The focus group meeting started with a presentation defining the scope and purpose of this project, the findings from the modeling efforts and their implications for RWH system sizing and thus building designs, and some of the perspectives of the project principles of the marketing issues to be considered. The participants were then guided by a moderator (Rima Petrossian, TWDB) through a series of questions aimed at drawing from the participants their perspectives on these issues, other issues which they considered relevant, and their views on the marketability of the RWH water supply concept. Reviewed below are the general categories of issues and implications offered by the focus group participants and the challenges they may present to implementing this strategy in Texas Hill Country developments.

Education is Key

A theme running through many of the comments and suggestions made by the focus group participants is that education of all those who would participate in bringing the RWH water supply concept to fruition is key to making it happen. This section reviews educational aspects highlighted by the participants.

Developers need to be educated about the very possibility of this concept, as well as how to move it through the regulatory and planning processes. These factors in turn highlight the need to obtain clarity in the regulatory and planning processes, which would entail education of the regulatory system itself about various aspects of this concept. Developers also need to understand implications for costs, and of the timing of when costs would be incurred. Indeed, the ability of this concept to relieve a developer of considerable up-front cost to install a conventional water supply system is expected to be a major incentive for him/her to consider this RWH concept. Land planners and engineers who advise the developers also need to be educated about the requirements of an RWH supply strategy, including the right-sizing of systems (as indicated by the modeling process – see Section II), about the cost issues, and about the regulatory environment.

Architects and homebuilders need to be educated about the implications of right-sizing the RWH system for building design, and the methods and opportunities for incorporating the required roofprint, and perhaps the cistern, into more cost efficient building designs. This goes hand-in-hand with orienting the homebuilders toward such designs, and perhaps some alterations in their building systems and practices to incorporate them. Along with this, an understanding and appreciation needs to be imparted of other benefits obtained from such building designs – e.g.,

shading walls and lower cooling demands, providing outdoor living space which is usable a large portion of the year in this climate.

All these groups also need to understand the RWH strategy in the context of the larger water system. This includes the need for a conservation ethic in regard to sizing, and thus costs, of RWH systems. Also to consider the concept of whole water – e.g., such practices as using that hard-won rainwater once in the building and then again for irrigation by using a waste water system that would treat that water appropriately and route it to an efficient irrigation system.

A major need pointed out by the finance and real estate stakeholders is to educate the appraisal system to recognize the value added by RWH. This is important because the building cost would be increased to encompass the RWH facilities, so in order to justify a loan covering those costs, the appraised value of the building would have to reflect an increase in value imparted by the RWH facilities. This would entail an understanding of life-cycle costs vs. first costs, and a mechanism for considering the former when determining the value of the house to a buyer.

The latter point highlights that finance and real estate stakeholders need to be educated about the intrinsic value of RWH as a water supply strategy. On a purely mechanistic level, the financiers need to come to understand that RWH is indeed a viable water supply strategy, a mainstream strategy waiting to happen, not an exotic practice sequestered to a few dedicated individuals. Beyond that, there needs to be an appreciation of how going with the RWH concept insulates the building owner from future rate shock, as water prices demanded by conventional water supply systems are expected to escalate, and the very availability of some of those conventional supplies is expected to contract. The latter is evidenced, for example, by the Hays County rules requiring an average lot size of 6 acres in developments which would draw their water supply from the Hays-Trinity aquifer, due to expectations that continuing development at higher intensities would overdraw that supply. Such rules would have implications for the style of development that could be offered and for the land cost basis that would have to be recovered in the building price.

Consumers likewise need to be educated, both about the general value of RWH as a water supply strategy and about the realities of living on rainwater. The latter includes both the pluses of the high water quality that RWH provides and the long-term cost advantages, and the need to adopt a conservation ethic, particularly as it relates to right-sizing of the RWH system in order to minimize needing to import backup supply, as well as the operations and maintenance requirements to assure their RWH system continues to deliver a safely potable water supply.

Beyond all this, there is a more universal education element. Stakeholders pointed out that a conservation ethic is evolving, that there is a generational aspect to this. An example cited is: no one used to think about recycling, everything just went to the dump, but now recycling is fairly well institutionalized. Likewise, an understanding and appreciation of a conservation ethic is expected to evolve, particularly in a region like this which faces looming water supply challenges.

Then too there is education at a more practical level. An inevitable question is, “What if it doesn’t rain?” On one level, the response is that the right-sizing of RWH facilities takes into account that there will be droughts, perhaps as severe as the 2010-2011 drought, and right-sized RWH systems would get through those periods without incurring unreasonable quantities of backup water supply. However, on a more universal level, an understanding needs to be imparted that, if there were to be a severe, long-term drought, then ALL water supply systems would face challenges. In particular, those drawing from local groundwater in the Hill Country

may be particularly vulnerable. While it may impose a fiscal burden, RWH system users could continue to import backup supply from conventional sources, unless those sources also dried up. But if a drought were that severe and prolonged, it is likely that this region would precipitously depopulate, and the fate of individual RWH system users would be a very small issue relative to the dislocations occurring over the region generally. All of which is to say that drought-induced issues for RWH system users must be considered in a broader context. As one stakeholder stated, “Education about rainwater harvesting reduces fear.”

Governmental/Regulatory Issues

The thesis of this project is that the RWH water supply strategy would be implemented at the building scale – that is, each building would have its own self-contained RWH system. In the main, as long as that is the modus operandi, under prevailing conditions these systems would remain essentially unregulated, with the RWH systems being on a basis similar to that of a private well. This being the case, expect for public buildings – e.g., churches, community centers, commercial centers – governmental and regulatory issues would center on local rules rather than on the state level rules that govern conventional water supply systems.

Before proceeding to consider those local rules, the stakeholders noted that RWH systems to serve those public buildings are in need of greater regulatory clarity. Discussions with TCEQ must proceed in order to impart regulatory clarity for residential-scale RWH systems that rise to the level of a public water supply system. Also, it was noted by stakeholders that backup supply to residential-scale RWH systems may also entail some degree of involvement by TCEQ. Here too discussions with TCEQ must proceed and regulatory clarity regarding the rules that apply to backup supply systems must be attained.

Turning to the local regulatory environment, the stakeholders noted the need for clarity about requirements that may be applied to establishing and to running a development-wide water supply strategy consisting of a collection of residential-scale RWH systems. Developers are particularly concerned about regulatory clarity, so there is a “chicken or egg” conundrum at play here. A developer would not want to commit to a project without having the county establish a clear set of requirements for approving a plat which declares RWH to be the sole water supply system for that development. Primarily the counties do not appear to have considered in any depth what rules would apply, simply because such proposals have yet to be presented.

Another governmental/regulatory aspect noted by stakeholders is the level of support that RWH may receive both in terms of mitigating the costs of RWH systems and of the benefit this practice may impart to the stormwater management function. It was noted that some tax credits are currently in place and others are under consideration, and that these might encourage RWH, at some level. Regarding stormwater management, rules in some local jurisdictions seem to retard RWH. Working through the relationship of an RWH system to both the detention function and the water quality function is needed in order for the benefits of RWH to local hydrology and water quality to be understood and applied as a possible incentive, rather than remaining a barrier.

Finally, stakeholders noted that the relationship of a development employing residential-scale RWH as the sole water supply strategy to a CCN holder for the area covering that development must be clarified. It was brought to question whether such a development might opt-out of extending a waterline from the CCN holder’s system in favor of RWH. Also to be clarified is

the prerogative of CCN holder to be the management entity and/or sole provider of backup supply within the development.

Costs and Financing

As noted, a prime concern in regard to financing of houses with RWH systems is to determine how the appraisal process can incorporate a value for the RWH facilities that may be commensurate with their costs, so that a loan to cover these costs can be justified to the financing community. No clear resolution to this problem was offered, other than experience over time inputting comps into the system so that appraisers can take them into account. Lenders should also be educated regarding the life-cycle cost impacts vis-à-vis the expected future increases in the costs of conventional water supplies, and also the prospects for the long-term viability of financing a well instead of an RWH system.

In general, however, it is perceived that many lenders do/will accept RWH as a legitimate water supply system for a home, and so will make loans for houses which would be solely dependent on this water supply strategy. Concerns were expressed about the costs that RWH facilities would impose and the ability of a large market to afford and/or qualify for a loan. This concern can be addressed in part by coming to understand long-term affordability issues vis-à-vis conventional supply sources. Again, this is the same problem as noted regarding appraisals – recognition of life-cycle cost issues and how RWH could insulate the homeowners from future rate shock.

It was understood that the affordability issue may also be addressed/attacked by formulating home designs based around RWH from the beginning, as opposed to retrofitting the RWH facilities into existing designs. As has been suggested by this project, funding of studies and/or design competitions in architecture schools may be a good step toward generating such designs. It has also been suggested that this could be a business opportunity for architects inclined to cater to this market. It was asserted that 75% of the housing market in Central Texas is for homes costing \$250,000 or less, so that outlines the dimensions of the challenge.

Concern was expressed about the costs of backup supply and – once there were hundreds, or even thousands, of RWH houses online – the continuing availability of an assured backup supply on demand. As has been reviewed in this project, this is a prime reason that right-sizing of the RWH facilities will be critical, so that a backup supply system would be far less likely to become overtaxed. This in turn impacts on the capital cost of the RWH facilities – additional footprint and a larger cistern. Again, this is an educational issue, to inform all those involved in decisions about system sizing relative to first cost impacts and on-going viability of backup supply systems.

Concern was also expressed about future cost uncertainties, largely in a “what if” scenario setting. One explicit question posed was, “What if my cistern becomes contaminated?” This highlights the need for a robust O&M protocol, both to hopefully preclude such a scenario and to effectively respond to it if such a circumstance were to be encountered. Another was, “What if my cistern starts to leak after 10 years?” That highlights a need for good quality control when installing RWH facilities and/or a reasonable protocol to repair a cistern. What the latter might be would depend on the type and configuration of the cistern. These sorts of concerns urge consideration of how to make the facilities robust and adaptable. These are system design issues, targeted for further investigations and educational programs.

Another cost issue deals with the up-front costs a developer incurs to create the development. As reviewed in this project (see Section VII dealing with cost analysis), relieving the developer of up-front costs to install a water system should result in lower lot costs, which would defray the cost escalation incurred to provide the RWH facilities to serve each house. In any case, being relieved of those up-front costs reduces the developer's fiscal risk to create the project, so may urge more developers to consider this option. Again this is particularly so where the other low-first-cost option would be to place more and more demand on local groundwater, which may prove not to be viable. As noted, this is a matter to be addressed by an educational program aimed at developers and the planners and engineers who serve them.

Water Use, Quality and Conservation/Stewardship

There was general recognition among the stakeholders that, properly managed, roof-harvested rainwater is high quality water, valued for its softness. However, there was not that general understanding of recommended treatment and maintenance practices. This suggests the value of developing a standard treatment train and a standard maintenance protocol for that treatment train, and for the balance of the rainwater harvesting system.

A few stakeholders noted the value to rainwater harvesters of low-water use landscaping practices, one even suggesting that native plant landscapes should be the landscaping ethic of rainwater harvesters. One stakeholder also noted the high value of wastewater reuse to defray landscape irrigation demands. The modeling clearly shows that using rainwater directly from the cistern for maintenance of any significant amount of irrigated landscaping would impose significant upsizing of the roofprint and cistern volume, increasing capital cost, or would significantly increase backup water requirements. Modeling also shows this could be largely relieved by utilizing wastewater – water from the cistern that is first used in the house – to meet irrigation demands. As noted, education about these aspects of this strategy would inform choices regarding the style of development and guide decisions about wastewater management.

Stakeholders noted that limits on water demand rates would impose lifestyle choices in regard to such amenities as large whirlpool tubs. It was noted, however, that such luxuries are typically limited to larger, more expensive homes, which typically have large roofprints as a matter of course, so that the market would be somewhat self-regulating of such water uses. In any case, again the adoption of a conservation ethic by rainwater system users is recognized as a marketing imperative.

Swimming pools were noted as challenging by one stakeholder. Pool makeup water requirements may typically run to many thousands of gallons, more even than the typical annual interior use by one person. This would either limit the market to those who don't care to have a swimming pool, or require that sufficient additional roofprint and storage be added to the system to account for that consumption. Or that the pool be kept covered when not being used to limit evaporation.

Water needs in a development for uses other than in the homes or on the lots was identified as an area of concern regarding the marketability of a development. This would apply to the type of development that offers amenities such as athletic fields, vanity ponds, etc. Stakeholders suggested that such developments might serve these ends by rainwater harvesting off the landforms, or from roof areas dedicated to supplying those amenities, and storing this water for those uses. Another expression of the conservation ethic noted by a stakeholder would be to

minimize amenities like ponds, and to provide other styles of ornamentation of the development that would consume little water.

Taken together, the factors noted in the previous paragraphs urging the conservation ethic led some stakeholders to see a population of like-minded buyers to be the early market for this water supply concept. They stated the viewpoint again, however, that such an ethic is emerging, and may indeed be a driver of the market, rather than such concerns being a retarder of the market. This ethic extends to concern for the local and regional water environment, with such values as Jacobs Well and Cypress Creek being noted, implying that there is a ready market for homes in a development which espouses and supports that ethic.

Perceptions

Under this heading again it was stated by some stakeholders that this concept is for the right buyer, for a like-minded community, meaning one inclined toward practicing the conservation ethic. The perception of this concept being green, thus appealing to those who value community and ecological stewardship, was again asserted.

The flip side of this is a perception among some potential homebuyers that limiting water use equates to deprivation, or limiting one's lifestyle. Some of the stakeholders consider a like-minded community to be a fringe market at present. The key to broadening the market, they felt, was to change the perception. Education of the buyers about the capabilities and limitations of rainwater harvesting, and the impact of those choices on the cost of a right-sized RWH system is needed to better inform the market.

This also highlights that, relative to the issue of water-demanding amenities noted here, the style of the development is a matter of taste, and to some degree is driven by the sort of environment in which one wishes to live. An example offered was a development with housing densities requiring an organized wastewater system, but supporting various community amenities, vs. a lower density development, of the style typically served by on-site wastewater systems, without such amenities. The difficulty of fitting homes with the roofprint required for right-sizing onto the smaller lots of the denser development was also noted as perhaps limiting this water supply strategy to those lower intensity developments. Indeed, it is a perception of the study team that it would be in such lower intensity developments where this concept may first take hold.

Another perception offered, however, was that this concept faces what may be lumped under design challenges and it is their resolution that will determine what style of development this strategy may successfully serve. In regard to aesthetics, one opinion was that a lot of buyers would not accept a large free-standing tank encumbering their yard. This opinion presumed the lots would be fairly small, so again bringing up the question of lot size relative to marketability of the concept. Those design issues also deal with architectural style and building practices. Establishment of one or more RWH house design styles may be key. A perception offered was that once a pattern is established, it would become accepted.

Regarding the concept taking hold, another perception offered was that the early adopters need to be successful, both in filling up the subdivision fast and in terms of the RWH system providing fairly trouble free, high quality water service. It was suggested that a study be commissioned to survey existing RWH practitioners to gage the degree of satisfaction with cost/value, water quality, water usage, etc., perceived by these homeowners, and to clarify the practices needed to maintain high quality service. Assuming good results from such a survey, it was perceived that

dissemination of those results could broaden the market by blunting the fear of the unknown factor that this non-conventional water supply strategy may impart.

Finally, some stakeholders asserted that the perception of need for the RWH water supply strategy may be driven in some degree by the perception of the condition of the conventional water supply systems. They stated that some buyers would need to see reasons why it is better, as we have water today. This is particularly so because employing the RWH strategy would relieve the developer of up-front costs, as noted previously, and increase the cost of the house to the homebuyer. This was seen by some as a hard sell, but it was stated that education about the prospects for cost escalations to continue, and to become more severe, in order to expand and supply conventional strategies would make it easier.

Fire Protection and Insurance Liability

A matter in need of further exploration is how to arrange for fire protection in developments which would employ the RWH strategy. It was noted that the general level of liability would be similar to that in developments served by private wells, so in terms of fire insurance liability, this concept may not be in a disadvantageous position, practically speaking. Recent experience in this region has also brought wildfires to the fore as a concern for developments in rural areas.

One answer to these concerns noted by the stakeholders was to require each cistern to have a connection that could be tapped by a fire truck, so that every cistern could be available as a source of firefighting water. Another was to install a dedicated fire suppression tank, supplying it by collecting water off a community pavilion or off landforms. Costs of such options would need to be evaluated.

Overall, it was agreed that fire protection is an issue in need of further investigation, both in regard to means of providing protection and to impacts on house insurance rates. This has been noted by the project team as an item for further work.

Impressions of the Market

In closing the focus group meeting, four questions/issues were posed to the stakeholders. The first was “Tell me the reasons you could or would advocate for this concept. What are the strengths of this concept from your personal or business/industry perspective?” The answers echoed much of the previous discussion. In no order of priority, the stakeholders offered the following:

- The concept represents conservation/stewardship.
- It is better for the next generation, as it addresses the perceived unsustainability of conventional water supply strategies, particularly continuing exploitation of groundwater supplies.
- Allied with this is the perception of water limits in this region that this strategy may become a necessity.
- Up front cost savings to the developer because no community water supply system is installed.
- This strategy goes to the source of the water supply, the implication being it is more efficient and less wasteful.
- The innovative nature of this strategy is appealing.
- An overall cost savings in energy and infrastructure to provide water supply.

- It could lead to building better houses.
- An RWH may improve property value (running against other perspectives on cost issues).
- It is insurance against a mega-spike in water prices.
- It offers improved water quality and quality of life.

The second charge to the stakeholders was “Tell me what concerns you about this concept. What are the barriers that need to be addressed from your personal and/or business/industry perspective? Can these barriers be overcome?” Again the answers echoed much of the previous discussion. In no order of priority, the stakeholders noted the following factors:

- The first project has to be exemplary.
- Need to identify hidden costs and liabilities.
- The appraisal rules need to be addressed.
- Financing needs to be addressed, buyers need to be educated about availability.
- The concept may be difficult for some to embrace, depending on buyers’ values, perceptions about limitations on water use and resistance to lifestyle changes that might require.
- This is a niche market, need to identify and target that niche, to connect with the right buyer.
- The regulatory environment needs to be clarified, on both the state and local levels.
- How will climate change impact rainfall patterns, will a system that is right-sized based on historical modeling be able to provide adequate supply in the future?
- How much of a crisis will there be in regard to obtaining/assuring conventional water supplies, and how much will it cost to address it?
- The conventional water sources are currently too cheap so the buyer does not perceive the value of the RWH strategy.

The third question was “How would you sell the concept to your friends or colleagues?” The stakeholders put forth the following means:

- Bundle RWH with other concepts of sustainability.
- It is off the grid, offers freedom from a water system, offers independence.
- It is a holistic approach.
- High water quality, aesthetic/health benefits.
- Better future for the next generation.
- It is a targeted market, appealing to that market.

The last item posed to the stakeholders was “Describe a person or family that would choose to live in a subdivision where rainwater was the water supply source.” These are the characteristics they offered:

- Baby boomers, who are becoming empty nesters and/or retiring.
- Educated parents.
- Gen-Y.
- Desiring to be off the grid.
- Green-minded.
- Amenable to peer pressure to conserve.
- Millionaires.
- Shop at Whole Foods, drive a Prius.
- Fans of solar power.

Summary and Next Steps for Marketing Issues

Overall, the stakeholders presented a fairly positive view of this residential-scale rainwater harvesting strategy as the water supply system for whole developments, although they noted the cost issues and questions about the style of development in which this concept may be practical. A number of matters were noted as being in need of further investigation or development. Listed below, in no order of priority, are those matters, and the project team's recommendation for how they may be addressed:

- Further exploration of building design issues. It is suggested that further outreach to architects be done to stimulate their pursuing a Hill Country rainwater harvesting vernacular house design concept. It is also suggested that funding be provided to engage one or more architecture school graduate students to explore the options for how to most cost efficiently create such designs.
- Survey homeowners currently employing RWH for water supply to explore their costs, savings, water use, and changes in practice that being on RWH may have induced.
- Clarify regulatory issues. That was attempted within this project, and was met by limited interest and cooperation on the part of the state and local regulatory agents. Further work focused on this matter is recommended.
- Generate land plan examples of projects that would be organized around this water supply concept. An example cited was the University of Texas Architecture School project run by Dr. Kent Butler examining this and other innovative water management concepts for Rocky Creek Ranch in Hays County (Hillcountryalliance.org/uploads/HCA/IntergrativeWaterManagement.pdf).
- Fund a project which would utilize the residential-scale RWH strategy as the water supply system for a development project. A suggestion offered was for TWDB to fund a project through the West Travis County Public Utility Agency, which serves an area within which future water availability may be problematic, thus would appear to be a prime candidate for considering the RWH strategy on an institutional level.
- Address the appraisal issue. Other than education of the appraisal community, no specific action was suggested. Further investigation of how appraisals can be rendered to reflect the value of the RWH facilities is recommended.
- Investigate/address barriers at funding institutions such as Fannie Mae and Federal secondary lending institutions. The exact nature and severity of any such barriers is unclear at present, noting again that the local banker who participated in the focus group asserted that his bank will make loans for houses employing RWH for water supply. These barriers should be investigated and clarified.
- Investigate insurance issues, in particular the impact of employing the RWH water supply strategy on fire insurance rates.

- Develop educational resources for various audiences: developers, homebuilders, architects, consumers. That is a prime focus of this project, and all the project results will contribute to that education of the various stakeholders.

IX. Sustainability Implications of Broadscale Use of Residential-scale Rainwater Harvesting for Water Supply

If residential-scale RWH systems were to be widely employed as the water supply strategy, three potential impacts on the sustainability of local and regional water systems can be identified:

- This strategy would reduce stress on conventional water supplies, in particular on local groundwater, the sustainable use of which is at issue over much of the Texas Hill Country, the primary target area of this project.
- The sequestration of roof runoff in rainwater cisterns may impact the amount of runoff that ends up as streamflow downstream, and thus on the sustainability of water supplies that depend on that streamflow, a matter reviewed in detail in Section VI.
- Sequestration of roof runoff in rainwater cisterns may positively affect management of stormwater, as it impacts both on water quality and need for detention to prevent increases in downstream flooding that may be induced by development.

Each of these potential impacts on sustainability is examined below.

Sustainability of Water Supplies

The contribution of the residential-scale RWH water supply strategy to the sustainability of water supplies is multi-faceted. It goes beyond simply displacing supplies drawn from conventional water sources, rendering those more sustainable. In particular, the RWH strategy may substantially contribute to the sustainability of development – at least of development absent long-distance water importation systems from distant aquifers – in areas overlying aquifers that are already under major stress. A not insignificant aspect of that stress is loss of springs due to a lowering water table. This damages the watershed ecology and decreases streamflows, impacting downstream water systems that depend on those flows. Because this is the case over portions of the Hill Country, the ability to develop at anything but very low density may depend on successful implementation of the RWH strategy.

The case of western Hays County, where groundwater supply would be drawn from the Hays-Trinity aquifer, is an example. The Hays County Commissioners Court has established one house per 6 acres as the maximum density for developments that would obtain their water supply from that aquifer, as a measure to limit the drawdown of that aquifer. The RWH strategy would relieve developers from that restriction, while enhancing the sustainability of that aquifer.

As noted, an option would be to implement long-distance water importation schemes. This is expected to result in very high water prices, due to the long pipeline required to access remote aquifers, and also to the energy required to move water through such pipelines, particularly to areas at higher elevation. This indicates that, despite the high capital cost of residential-scale

RWH facilities, the RWH strategy may still result in a more fiscally sustainable water supply system over much of the Hill Country.

A residential-scale RWH strategy is inherently more sustainable, in two regards. One is that RWH systems would consume less energy than would conventional water supply strategies. In collective water systems, energy is consumed to provide water treatment and to move the water to the points of use. As just noted, energy requirements would be particularly high for long-distance water transfer schemes, but even localized systems incur significant energy costs to pump water. Pumping water is the largest energy use in most municipalities. Even in the other point-of-use water supply strategy, the private well, the lift out of a well is much larger than it is out of rainwater cistern, so incurring greater energy use. Less energy use is more sustainable, not just in terms of energy cost and all the externalities of energy use such as carbon emissions, but also because large quantities of water are required for the production of energy from fossil fuels plants that currently provide most electricity. This water demand directly impacts the sustainability of water supplies and will increase with additional development.

The other is that RWH is inherently more efficient at conversion of rainfall into useable water supply. Close to 100% of the rain falling on a rooftop can be captured and stored, given a sufficiently large cistern. Most of the losses in the RWH strategy would be due to cistern overflows, which are not losses to the general water environment, rather would potentially contribute to the conventional water supply system in the watershed as a whole.

In those conventional water supply systems, however, there are very large losses between the point the rainfall hits the surface and it flows out of the tap as useable water supply. For example, studies show that on average 83% of the rain falling on the watershed which feeds Barton Springs in Austin is lost to evapotranspiration (Woodruff, C.M. and R.M. Slade, 1984; Slade, R.M., M.E. Dorsey, and S.L. Stewart, 1986). A portion of this rainfall supports plant growth and other environmental functions in the watershed, so, from an ecological perspective, the loss is much smaller. Ultimately, a very small portion of the total rainfall makes it into the aquifer which this area recharges, and so would be available for water supply.

Similarly, such rainfall losses also limit the amount of water that becomes streamflow and may make it to storage reservoirs, such as the Highland Lakes. There, another major mode of loss comes into play – evaporation from the reservoir surface. Such losses are anything but trivial. It was reported that the evaporation losses from the Highland Lakes in 2011 were greater than the amount of water produced and delivered to its customers by the Austin Water Utility (Lake Austin Blog).

Another way in which the RWH strategy enhances sustainability is that largely living on the water that can be captured from one's rooftop disciplines the practice of water conservation, instilling a conservation ethic. Not only does this allow the users of RWH systems to live more fully off the roof-harvested rainwater – that is, to minimize importing backup water supply – but it sets an example for broader society that a perfectly reasonable lifestyle can be supported on significantly lower interior water usage rates than are typically presumed to be required. Eventually, these expectations may be adopted as planning goals in place of the excessive rates upon which water system design is presently predicated. This would enhance the overall sustainability of all water supply systems, in terms both of sustaining the supply and of reducing overall system costs so these systems would be more fiscally sustainable.

Another aspect of this conservation ethic is that living on roof-harvested rainwater encourages understanding and practice of a holistic, integrated water management strategy. In particular, if a rainwater harvester wishes to maintain any significant area of improved landscaping that may require irrigation; he/she is well advised to reuse wastewater for this purpose, thus integrating water supply and wastewater management. The modeling of RWH systems (see Section II) shows that supporting significant irrigation use directly out of the rainwater cistern would require a much larger roofprint and cistern volume, or the user would endure a greatly increased frequency of backup water being required. If the latter were chosen as the water source for irrigation, that may negatively impact the sustainability of the water systems from which the backup supply was drawn, in particular groundwater sources in the Hill Country.

Thus, after using it once in the house, instead of running that hard-won water supply to a traditional septic system that focuses on disposal, a type of on-site system could be used that provides high quality pretreatment and disperses the water in a subsurface drip irrigation system. The drip irrigation field could be installed around the highest value landscaping, providing a very large majority of the irrigation water use required to maintain landscaping. RWH system users might popularize this concept, and facilitate its adoption as a best practice within water conservation programs.

This would be particularly applicable in areas where continuing drawdown of the aquifer would damage ecological and/or commercial values – values the community would like to sustain. An example of this is the Cypress Creek watershed where the Cypress Creek Project adopted the pretreatment/drip irrigation system as a best practice. This is one of those areas, noted above, where loss of springflow would damage both the ecosystem and other community values. Further drawdown of the aquifer there would cause Jacobs Well to stop flowing, drying up Cypress Creek, which runs through the heart of Wimberley, along its commercial square. The creek going dry may damage property values all along it, in particular in the square, and the loss of perennial flow will fundamentally alter the creek's ecosystem. A recent report by The Meadows Center for Water and the Environment highlights these potential economic losses to the Wimberley community².

Finally, broadscale use of the RWH strategy rather than implementing the long-distance water transfer systems noted above would minimize the degradation of sustainable water in the areas from which the water would be imported. There is a considerable school of thought among residents of those areas that their aquifer is being raided at the cost of long-term sustainability and economic viability for those localities. The broadscale practice of RWH in areas where that water might be sent, instead of exporting this water to them, would enhance the sustainability of both areas – those supplying and those receiving this water.

In summary, basing water supply strategy on residential-scale RWH enhances sustainability by four means:

- **Directly sustaining water availability by reducing demands on conventional water supplies.** For aquifers already under stress, RWH enhances the sustainability of those water supplies and the spring fed ecosystems those aquifers support by reducing withdrawals required to support additional development. RWH also will enhance the fiscal sustainability of conventional surface water and groundwater supplies by minimizing the need for very

² Assessment of the economic contribution of Cypress Creek to the economy of Wimberley, Phase II Final Report - <http://www.txhillcountrywater.org/>

high cost long-distance water transfer schemes associated with new development in areas without existing water conveyance infrastructure.

- **Urging a conservation ethic.** Increasing public awareness with respect to water consumption can be accomplished through the use of RWH demonstrations and information. RWH users develop a conservation ethic that may eventually lead to lowering of standard interior water usage rate presumptions, enhancing the sustainability of all water systems, both in terms of water use and in fiscal costs required to secure additional supplies.
- **Supporting a focus on the integrated management of all water flows to maximize beneficial use of water.** A whole water approach is expected to increase sustainability compared with the continuance the presently prevailing “once-through” model which addresses wastewater and stormwater runoff as nuisances to be made to go away rather than being retained to contribute to plant health and maintenance of baseflow in creeks, streams, and rivers, as well as aquifer recharge.
- **Lessening demand and pressure on aquifers which have been targeted as water sources for exportation.** Even where groundwater transfers are do occur, RWH may extend the supply retained for local uses by reducing the total amount needing to be withdrawn and sent away.

Impact on Sustainability of Downstream Water Supplies

It is important to consider effects on streamflow if RWH were to be practiced on a broad scale over a watershed. Any substantial reduction in streamflow could potentially impair the sustainability of water supply systems which depend on those surface water resources (and any contribution they may provide to recharging ground water). This matter is explored Section VI, which concludes, through two modeling exercises, that there would be no discernible impact of RHW on recharge and streamflow. Findings are briefly reviewed here.

Certainly if every building in an *existing* development began to sequester a high percentage of rain falling on its roof, a decrease in the amount of quickflow runoff from that development would be expected. However, since the RWH water supply strategy would be practiced in *new* development, the proper comparison is between the runoff from the undeveloped land vs. the runoff from a development that employs the RWH strategy, not between that development with and without RWH being practiced. To suggest otherwise is to assert that development owes an *increased* amount of runoff to downstream water rights holders, simply because the land is being developed. And clearly, there is no such expectation in either water law or practice.

Comparisons of a watershed unit with and without RHW conclude that reduced streamflow may be a valid concern *only* if the watershed were highly hydrologically degraded, producing high rates of runoff from land in an undeveloped state. This is an undesirable, degraded state, not the natural condition of the land, and the aim of land conservation practices is to improve hydrologic integrity, so it is concluded that basing policy on impacts due the unnaturally degraded condition of a development site would not be sound. On less hydrologically degraded land, the increase in runoff induced by landform alterations and the impervious cover other than roofs overshadows the sequestration of roof runoff in the rainwater cisterns.

Development is typically required to implement stormwater management systems to retain or detain some of the increased runoff to protect downstream properties from increased flood

hazards. As reviewed in the next section, broadscale practice of residential-scale RWH would blunt the flash hydrology imparted by development, assisting that stormwater management function.

Note also that the water sequestered in a rainwater cistern is not removed from the watershed, it is merely retained in it. Appearing as wastewater after being used in a building, a portion of it may contribute to enhancing baseflow in streams. Thus, in terms of usable streamflow downstream, tipping the balance away from increasing quickflow and toward enhancing baseflow under the post-development condition may be a positive contribution of the RWH strategy to sustainability of downstream water supply systems.

If that streamflow were itself to be harvested directly into a reservoir, then such a shift from quickflow to baseflow might not be seen as a benefit. Again, however, it has been shown by the modeling in Section VI that, on all but highly hydrologically degraded sites, development would typically increase the quickflow despite RWH being practiced in all the buildings in the development. Add to this that the development would not be routinely drawing water out of the reservoir for water supply, and it is concluded that broadscale practice of the RWH water supply strategy would not negatively impact on the sustainability of those water supply systems.

Impact on Stormwater/Water Quality Management

Many local jurisdictions in the Hill Country have adopted rules to govern stormwater management, regarding both stormwater quality and the impacts of stormwater runoff on downstream flooding. In certain watersheds, TCEQ has also instituted such rules. Both the local and state efforts in this arena attest to the importance of these stormwater management functions.

If RWH were practiced on all the buildings in a development, a positive contribution would be made to management of both stormwater quality and the impacts of stormwater runoff on downstream flooding, relative to the same development without RWH being practiced. In regard to water quantity, sequestering roof runoff in cisterns to be subsequently used in the buildings and then discharged as wastewater provides detention storage and delays release of the water, preventing runoff from contributing to downstream flooding problems.

The cisterns would overflow on occasion, of course, and these overflows may contribute to problems caused by the increased quantity of runoff produced by development. But most often cistern overflows would occur in response to large storm events, which produce high runoff rates in any case. The initial abstraction – the water retained on the land prior to runoff being produced – would typically already be filled by the time cisterns overflow; so much of the roof runoff overflowing the cisterns would have been produced as quickflow runoff even off the pre-development landform. Thus, overall, cistern overflows would not contribute significantly to impacts caused by the increased runoff that development induces. And during all storms which do not induce a cistern overflow – a large majority of all rainfall events – RWH removes the rooftops as impervious surfaces contributing to that increase in runoff.

RWH potentially reduces the volume of runoff that must be captured and treated. That lower volume of runoff to be captured and treated can aid in creating schemes intended to implement volume-based hydrology. This is a management approach which aims to mitigate the increase in the volume of quickflow runoff exiting the project due to development, and so retain/restore the hydrologic integrity of the site, as measured by the rainfall-runoff response. And by the multiplicity of sites being so managed, this can maintain the hydrologic integrity within

watersheds. In addition to blunting the water quantity impacts, it has been found that by controlling the volume of runoff, negative water quality aspects due to runoff from developed sites are much easier to address.

Roof runoff is lightly polluted relative to ground-level runoff to begin with – indeed, any cistern overflow would be runoff from a roof that had already been very well washed off, and so would be rather clean water – and so is not much in need of being run through a water quality management device. In the absence of RWH, the additional runoff from roof areas would dilute the stormwater and so blunt the treatment efficiency of stormwater quality management devices. With RWH, as noted the water quality volume required to be captured and treated (or infiltrated) would be significantly less, since rooftops typically comprise a fairly large portion of the total impervious cover created by development.

It is noted that none of the systems governing stormwater management have acknowledged the benefits of RWH to function as managing rooftop run-off. They can require stormwater treatment devices to be fitted as if RWH was not being practiced, they can consider the cistern as if it were a detention basin, or they can require the water quality volume to be evacuated from it within a given amount of time, in essence wasting a good bit of that potential water supply. In the latter case, this fails to acknowledge that overflows would occur in response to a very minor fraction of total storms, and that when overflows do occur, high rates of runoff would be produced from the entire development surface, as noted above. Thus, the interaction of RWH and stormwater management is an area that is in need of further investigation to produce rules that do recognize those benefits.

Integrated Water Resources Management

It is well understood that our water resources are part of a closed system – the hydrologic cycle. If we are to maximize the efficient and effective use of water, and so maximize sustainability of our water resources, our management system should recognize that all water exists in the context of this closed system. We should therefore design our management systems in accord with that understanding, as integrated systems, with the infrastructure that addresses each function being designed as an integrated component of an overall system.

Many of the factors reviewed above highlight that, at its heart, the practice of residential-scale RWH is a component of integrated water resources management. Water supply, stormwater management and wastewater management are all considered as facets of an overall integrated system. This contrasts with conventional water management practice, which is non-integrated, and focuses on each water management function within its own “silo”, isolated from the other functions.

As reviewed, RWH fosters integrating wastewater management into water supply as a means of reducing the size of the RWH facilities (or the volume of backup supply required) while allowing the system users to maintain an irrigated landscape. RWH also integrates water supply with stormwater management in the manners described in above. Key to all that integration is decentralization of the management facilities, with the highly distributed water supply function being a key component.

X. Residential-scale Rainwater Harvesting Facility

Requirements around Texas

While this project focused on the Texas Hill Country, it is of interest how the residential-scale RWH water supply strategy might fare around the state. This section reviews the results of a more limited model, covering 2007-2012, for a number of locations in addition to the original nine Hill Country communities, indicating what the right-sizing of the RWH facilities might be in each location, and the impact of that sizing on the amount of backup water supply that would have been required through the modeling period.

A total of 32 locations were modeled, including the 9 original modeling locations. As the results of the 25-year modeling (1987-2011) indicate that the critical period at all locations were in the droughts of 2008-2009 and 2010-2011, it was determined that all additional locations would be modeled for the period 2007-2012 (through October 2012). This greatly decreased the amount of data acquisition required while covering what is likely to also be the critical period at the other locations.

Modeling Locations

The 32 modeling locations are shown in Figure 9. They include the original 9 locations (Austin, Blanco, Boerne, Burnet, Dripping Springs, Fredericksburg, Menard, San Marcos, and Wimberley) as well as Llano and San Antonio in the Hill Country region and these locations in the following regions:

- Northeast Texas – Athens, Marshall, Tyler and Texarkana
- East Central Texas – Conroe, Lufkin-Nacogdoches and Somerville Dam
- North Central Texas – Bowie, Cleburne, Sherman and Waco
- South-Southeast Texas – Beeville, Corpus Christi and El Campo
- Rio Grande Valley – Edinburg and Laredo
- West Central Texas – Abilene, Brownwood, Hondo and San Angelo
- The High Plains – Lubbock

Bowie was chosen to represent the Wichita Falls area, and Somerville Dam was chosen to represent the Bryan-College Station area, because the web site from which rainfall data was derived does not have data for those cities over the period modeled.

“Right-Sizing” Criteria

The criteria for determining the right-sizing of RWH facilities at each location were based on minimizing the amount of backup water supply required through the critical drought period to a reasonable level. As reviewed in Section II, what is reasonable is subject to judgment, based on the presumption that backup supply would be provided by tanker truck. Roofprint was allowed to vary in increments of 250 ft², and cistern volume in increments of 2,500 gallons. In general, the RWH system had to supply at least 80% of the water use in the worst year, and as much as practical to avoid the need for more than one load of backup supply in any month. These criteria were allowed to be violated in a few cases, where increasing the system size to the next increment would not have appreciably changed the overall outcome.

Two types of developments were considered. One is termed a standard subdivision, having limited restrictions and few covenants or requirements. For this case, it was presumed that the

homes would be dominated by 3-4 bedroom houses, and that the standard occupancy for modeling purposes is 4 people. The other type is a development targeted at a senior's community, in which the standard occupancy is 2 people.

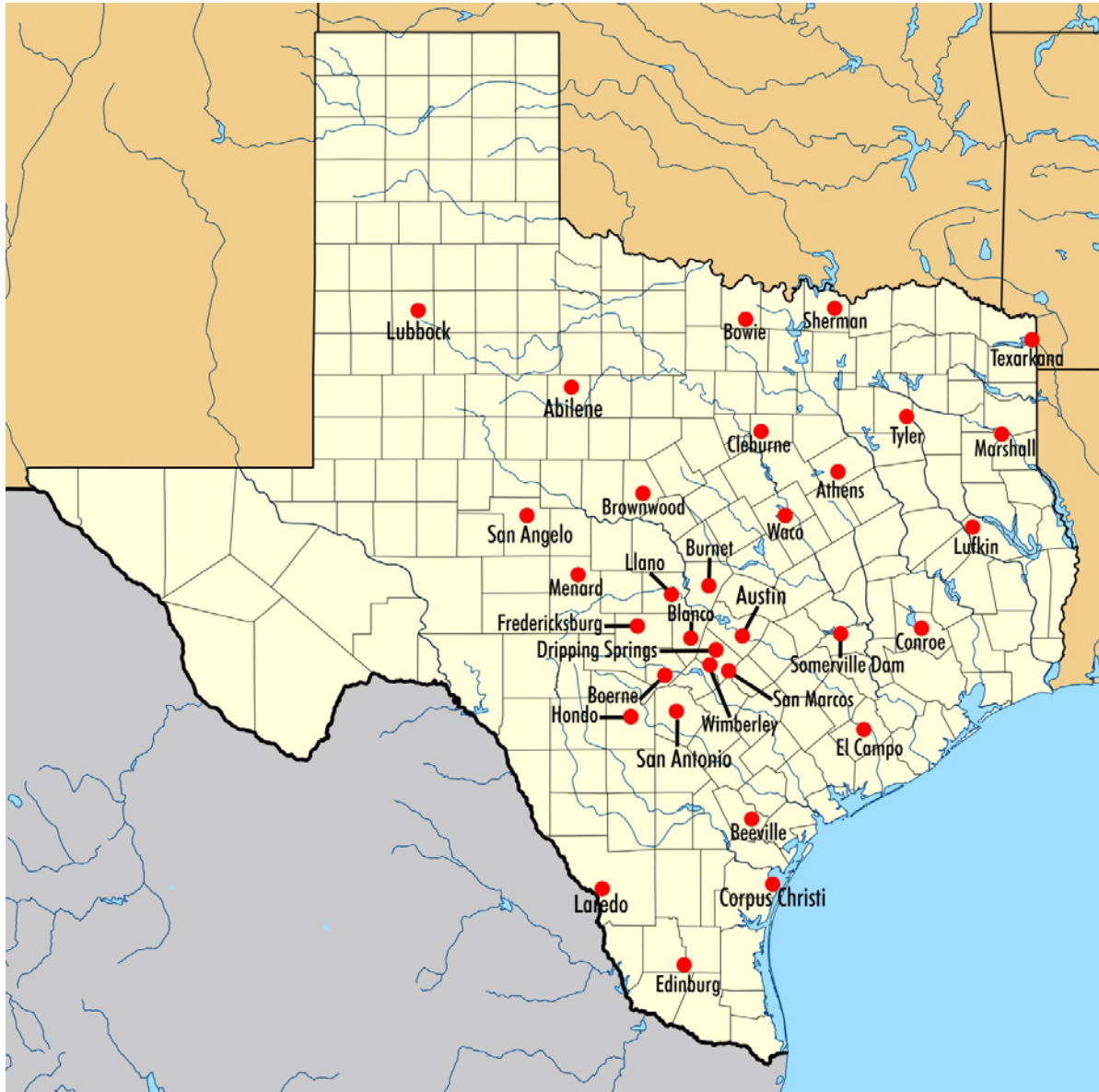

Figure 9: Modeling Locations for Residential-scale Rainwater Harvesting System Evaluation.

For homes in a standard subdivision, it is expected that between the house proper, with standard overhangs and allowances for interior walls, and a 2-car garage, a roofprint of 3,000-3,500 ft² would be provided as a matter of course. Therefore, a 3,000 ft² roofprint was the minimum modeled at any location, regardless of how little backup water supply this would result in being required. For a seniors-only development, it is expected that a house roofprint plus a garage or carport would provide at least 2,000 ft² of roofprint, but smaller roofprints were modeled for cases where this would result in reasonable backup supply requirements. In both cases, where larger roofprints would be required to attain right-sizing, it is presumed that verandas would be added to the house to increase the roofprint.

A standard water usage rate was utilized for all locations. Based on review of interior/indoor water usage rates using the currently available stock of new water fixtures, it was determined that 45 gallons per capita per day (GPCD) is a readily achievable goal for interior usage rate, and that 40 GPCD is an aspirational goal, achievable with a modicum of conservation effort. (See discussion of interior usage rate in Section II.) Two model runs were conducted for each location. In the first run, the standard water usage rate was 45 GPCD, with the usage rate reduced to 40 GPCD whenever the water level in the cistern dropped below the alarm volume. (It is posited that this is the behavior expected of those who would endeavor to utilize rainwater as a water supply source.) That alarm level was set at 37.5 days of supply at the reduced usage rate of 40 GPCD. In the second run, the water usage rate was 40 GPCD at all times.

Modeling Results for Standard Subdivisions

Table 28 displays the modeling results for standard subdivisions, presuming a routine water usage rate of 45 GPCD and a curtailed usage rate of 40 GPCD, with curtailment beginning when cistern volume drops below 6,000 gallons (37.5 day supply at the curtailed usage rate). Table 29 displays the modeling results for the same size systems at each location with a water usage rate of 40 GPCD at all times.

As was reviewed in Section II, the right-sized facilities for a family of 4 over most of the Hill Country would be approximately 4,500 ft² of roofprint and 30-35,000 gallons of cistern volume. In Fredericksburg, a little further to the west, a cistern volume of 40,000 gallons is indicated, and further out on the Edwards Plateau in Menard, that 40,000-gallon cistern and a roofprint of 5,000 ft² would be required. Table 28 presents the roofprint requirements for each modeling location. Table 29 shows that, if the lower usage rate of 40 GPCD were attained all the time, rather than just when the volume of water in the cistern dropped below the alarm level, the amount of backup supply would decrease considerably, typically to fairly trivial levels, in all these Hill Country communities.

Relative to those results, the right-sizing requirements indicated in Table 28 by the modeling in some other areas are surprising. In both Abilene and Brownwood, a smaller roofprint is indicated – 4,000 ft² in Abilene and only 3,750 ft² in Brownwood, both along with a 30,000-gallon cistern. In each of these locations, a level of performance was attained similar to that observed from modeling of the Hill Country communities with their larger systems. San Angelo is also surprisingly reasonable, requiring the same 5,000 ft² roofprint as in Menard, but only a 35,000-gallon cistern. It is also noted that in the Abilene and Brownwood areas, the 2011 drought continued into 2012, while most of the Hill Country communities recovered in late 2011 and early 2012. In these communities too, Table 29 shows that backup supply requirements would drop considerably if the lower usage rate of 40 GPCD were attained at all times. In Brownwood, backup supply requirements went to zero under that scenario.

Brownwood is particularly interesting because the city reportedly came very close to running out of water in its municipal supply system in 2011. Since a right-sized RWH system – of relatively modest size – would have skated through the 2010-2011 drought while incurring a fairly reasonable amount of backup supply requirement – as just noted, zero backup supply if a higher level of conservation were consistently practiced – this indicates that RWH may be a good option for addressing the water supply issues there. It may be called to question if the incremental investments, building by building, in RWH facilities might be globally more cost efficient, and indeed produce an overall more robust system, than the investments in technical fixes such as direct potable reuse that are being considered there.

Further south in this region however, in Hondo it was observed that a right-sized system would be similar to one in Menard, with a slightly reduced roofprint, as Table 28 shows. This indicates that Hondo appears to be in a different rainfall zone than Abilene and Brownwood, more akin to the Hill Country. There too the reduction in backup supply with the lower usage consistently being attained is considerable.

Moving further into the drier areas of the state, Laredo and Edinburg in the Rio Grande Valley and Lubbock on the High Plains are perhaps in climate zones too dry to entertain residential-scale RWH as a stand-alone water supply strategy. In those areas, Table 28 shows that the recovery from 2011 noted in most other areas appears not to have occurred, at least to the degree it did in other areas, and the backup supply requirement just through October in 2012 is close to or greater than it was for all of 2011. This is confirmed in Table 29, showing that there would have been no decrease in the 2012 backup supply requirements if the lower water usage rate were consistently attained. To employ the RWH strategy in these areas would require a very robust backup supply system. Such a system could be organized, so it would be premature to rule out RWH strategies in those areas. There may be niches in which this strategy would prove very advantageous.

There is an area encompassing the southern part of the Hill Country (Boerne and San Antonio), extending up to San Marcos, running west to Hondo and south to the coast, covering Beeville and Corpus Christi, where the drought of 2008-2009 created worse conditions for RWH than did the broadly more severe drought of 2010-2011. This is confirmed by Table 29, showing that backup supply requirements remained in those communities in 2009 even at the reduced water usage rate, a condition not observed in any other communities (except Blanco, where one load of backup supply would have been required in 2009).

Down toward the coast (Beeville and Corpus Christi) there was also an incomplete recovery from the 2011 conditions, and backup supply requirements continued into 2012. If the current dry winter conditions continue, 2012 may end up being relatively severe in terms of backup supply requirements. In El Campo, further to the east on the coastal plain, a significantly smaller RWH system would be required, and it incurred backup supply requirements in only 2011, with full recovery in 2012.

Everywhere else in the state, the right-sized RWH facilities are seen to be considerably smaller than in the Hill Country. In northeast and east-central Texas, most locations required only the nominal minimum of 3,000 ft² of roofprint, expected to be provided as a matter of course by a normal house design plus garage. Only in Athens and at Somerville Dam, both more to the westerly side of these areas, was a larger roofprint required – 3,250 ft² in Athens and 3,500 ft² at Somerville Dam. Except for Somerville Dam, where a 25,000-gallon cistern was indicated, a 20,000-gallon cistern would suffice, with only 15,000 gallons required in Texarkana. In the more easterly communities among this group (Conroe, Lufkin-Nacogdoches, Marshall and Texarkana), Table 29 shows that backup supply requirements went to zero when the lower water usage rate was consistently attained.

In north-central Texas, Sherman would require facilities similar to those required in northeast Texas, while Bowie, Cleburne and Waco would require 3,500 ft² of roofprint. In Bowie and Cleburne, a 25,000-gallon cistern would be required, while in Waco only a 20,000-gallon cistern would be required. Only in Sherman would backup supply requirements have gone to zero if the lower water usage rate were consistently attained, while small amounts of backup supply

remained in 2011 in the other communities. It is surprising that this concept appears so viable around Wichita Falls, which is moving out toward west Texas, and around Waco, given the conditions just south in Austin. These communities, along with Athens, surround the Dallas-Fort Worth metroplex, indicating that this RWH water supply concept would be viable in developments all around that area.

To summarize, the RWH water supply strategy investigated in this project would be as viable – or more so – over approximately the eastern two thirds of the state, as it is in the Hill Country communities that were the focus of this project. It may be questioned what might drive the use of this strategy in other areas. Impetus may be due to water availability from conventional sources, the high cost of increasing supply through conventional water systems, the high cost of extending lines to developments in rural areas, or the particulars of a local situation, such as was noted above in regard to Brownwood. In any case, this strategy offers an option for water supply to standard subdivisions over much of Texas, not just in the Hill Country.

Modeling Results for Seniors-Only Subdivisions

Table 30 shows the backup supply requirements for right-sized RWH facilities serving seniors only developments, having an occupancy of 2 people per home, with a routine water usage rate of 45 GPCD, reducing to 40 GPCD when the cistern volume drops below 3,000 gallons. In Table 31, the same sized RWH facilities at each modeling location are evaluated with a constant usage rate at all times of 40 GPCD, showing the reductions in backup supply requirements this would entail.

The results, and the pattern of results around the state, are similar to those observed in the modeling of standard subdivisions. However, having to support a smaller occupancy, the RWH facilities could be smaller. In particular the required roofprint in many locations would be at or below that expected to be provided as a matter of course by a living unit and garage (or carport). The lower cistern volume would also significantly reduce the cost of the RWH facilities, as cistern volume is the major driver of RWH facilities costs.

In northeast, east central and north central Texas, this RWH water supply strategy appears particularly attractive for 2 occupancy homes. The required roofprint at all these locations would be 2,000 ft² or less, so with appropriately design single-story houses there would be no extra roofprint required. The required cistern volume would be only 10,000 gallons in almost all these communities, the exceptions being Texarkana where only 7,500 gallons would be required and Somerville Dam where a 12,500-gallon cistern is indicated. While not trivial, cisterns of this size would be relatively affordable, and could be more readily integrated into the home design, perhaps decreasing the cost of storage.

As in the case of the standard subdivision, Table 31 shows that backup supply requirements would reduce to very low levels in all these communities if the lower water usage rate were to be consistently attained, rather than only when the cistern water volume dropped to the alarm level. Only in Bowie would backup supply have been required in 2009; in all the rest of the communities, backup supply would have gone to zero, or to fairly low levels required only in 2011.

In the Hill Country communities, in south-southeast Texas, and over most of west central Texas, roofprints of 2,000-2,500 ft² would be required, along with cistern volumes of 15,000-20,000 gallons. The only exceptions in these groups are Hondo, where a roofprint of 2,750 ft² is

indicated, and El Campo, where the indicated cistern volume is only 10,000 gallons. Above 2,000 ft², it is to be expected that extra roofprint would be entailed, and house designs incorporating some verandas are anticipated to be the most cost efficient method of providing additional square footage. The larger cistern volume would increase the costs of the RWH facilities, and would complicate designing them into the building structure, but it is the same sort of challenge to be met in the standard subdivisions, only to a smaller degree.

In these communities also, attaining the lower water usage rate at all times, rather than only when the cistern water volume was below 3,000 gallons, would reduce backup supply requirements to fairly low levels, required mainly in 2011 rainfall patterns. Again, the area running from the southern part of the Hill Country to the coast around Corpus Christi experienced more severe conditions for RWH in the 2008-2009 drought than in the 2010-2011 drought.

As for the case of the standard subdivision, Laredo and Edinburg in the Rio Grande Valley and Lubbock on the High Plains would require larger roofprints and cisterns, and again those areas did not recover in 2012. These areas may be a climate zone too dry for the RWH strategy to be considered viable as a routine water supply option, but here too the smaller facilities required for seniors-only developments might make this option attractive.

Summary for Facilities around the State

The results displayed in Tables 33-35 indicate that the RWH water supply strategy that is the subject of this project could be viable over most of the area covered by the eastern two thirds of Texas. In east, northeast and north central Texas, the rainfall patterns over the two drought periods that occurred in the 2007-2012 modeling period better supported RWH. This results in smaller roofprints and cistern volumes being required in these areas for a right-sized system, to hold backup supply requirements to a reasonable level, than were indicated for the originally modeled Hill Country communities.

Surprisingly, the concept appears at least as – if not more – viable over parts of west central Texas than it is in the Hill Country and the nearby IH-35 corridor communities. In particular, the concept appears quite robust in Brownwood, where the conventional supply system experienced significant challenges in 2011.

At most locations, 2011 was the critical year, but the area from the southern Hill Country to the Gulf Coast around Corpus Christi experienced an equal, or greater, challenge in 2009. In the Rio Grande Valley and on the High Plains, 2012 is shaping up to be as bad as, or worse, than 2011, indicating that the right-size of facilities in those locations might increase over those shown in the tables. As noted, the viability of the RWH water supply strategy is questionable in those drier areas.

A significant reduction in backup supply requirements was seen for most locations when the reduced water usage rate of 40 GPCD was maintained throughout the modeling period, relative to having a routine usage rate of 45 GPCD, reduced to 40 GPCD only when water volume in the cistern dropped to the alarm level. In several cases, backup supply requirements dropped to zero under the reduced usage scenario. However, the most western communities – in the Rio Grande Valley and on the High Plains – saw no decrease in backup supply in 2012 in the reduced usage scenario, again highlighting that these areas did not recover from the 2011 conditions as did the rest of the state. Abilene in west central Texas and Beeville and Corpus Christi in the central

coastal area also continued to require backup supplies in 2012, but at significantly reduced volumes relative to 2011 rainfall patterns.

RWH systems to serve houses in standard subdivisions would entail provision of extra rooftop in all areas of the state except northeast and east-central Texas, where the rooftop provided as a matter of course by the house and garage may suffice. These systems would also entail rather large cisterns, which pose the greatest cost challenge to implementing this water supply strategy. That urges the derivation of building design concepts which might more cost efficiently incorporate the cistern into the building design.

For a seniors-only project, many of the locations modeled would entail rooftop requirements that would have little or no extra rooftop, and in many other locations only a modest area. The cistern volume requirements are also fairly small for many locations, and of more manageable size in most other locations. This appears to make such communities a particularly attractive opportunity to employ the RWH water supply strategy.

In summary, the RWH water supply strategy appears worthy of consideration over a large portion of Texas. It remains to determine if that strategy would be more globally cost efficient than would other strategies for water supply in each area, an evaluation that would hinge on circumstances in each locality.

Table 33: Backup Requirements of “Right-Sized” Rainwater Harvesting Systems in Standard Subdivisions at Modeling Locations.

House occupancy = 4 people Cistern alarm volume = 6,000 gallons (37.5 days at reduced usage rate) Standard water usage rate = 45 GPCD Enhanced conservation factor = 0.888 (reduces usage rate to 40 GPCD)											
Modeling	Roofprint	Cistern Size	Backup Supply Required in Year						No. of years	Total	Max. year
Location	(ft ²)	(gal.)	2007	2008	2009	2010	2011	2012*	With Backup	Backup (gal.)	Backup (gal.)
Abilene	4,000	30,000	0	0	0	0	12,000	4,000	2	16,000	12,000
Athens	3,250	20,000	0	0	0	0	10,000	0	1	10,000	10,000
Austin	4,500	35,000	0	0	2,000	0	12,000	0	2	14,000	12,000
Beeville	4,750	35,000	0	0	12,000	0	6,000	4,000	3	22,000	12,000
Blanco	4,500	35,000	0	2,000	8,000	0	8,000	0	3	18,000	8,000
Boerne	4,500	35,000	0	4,000	8,000	0	8,000	0	3	20,000	8,000
Bowie	3,500	25,000	0	0	6,000	0	8,000	2,000	3	16,000	8,000
Brownwood	3,750	30,000	0	0	4,000	0	6,000	2,000	3	12,000	6,000
Burnet	4,500	30,000	0	0	6,000	0	8,000	0	2	14,000	8,000
Cleburne	3,500	25,000	0	0	0	0	8,000	0	1	8,000	8,000
Conroe	3,000	20,000	0	0	0	0	6,000	0	1	6,000	6,000
Corpus Christi	4,500	35,000	0	0	8,000	0	8,000	6,000	3	22,000	8,000
Dripping Springs	4,500	35,000	0	0	2,000	0	8,000	0	2	10,000	8,000
Edinburg	5,500	45,000	0	0	0	0	6,000	12,000	2	18,000	12,000
El Campo	3,500	25,000	0	0	0	0	10,000	0	1	10,000	10,000
Fredericksburg	4,500	40,000	0	0	2,000	0	12,000	0	2	14,000	12,000
Hondo	4,750	40,000	0	0	16,000	0	4,000	0	2	20,000	16,000
Laredo	5,500	50,000	0	0	0	0	8,000	12,000	2	20,000	12,000
Llano	4,500	35,000	0	0	4,000	0	8,000	0	2	12,000	8,000
Lubbock	5,500	40,000	0	0	0	0	16,000	14,000	2	30,000	16,000
Lufkin-Nacogdoches	3,000	20,000	0	0	0	0	4,000	0	1	4,000	4,000
Marshall	3,000	20,000	0	0	0	0	6,000	0	1	6,000	6,000
Menard	5,000	40,000	0	0	0	0	10,000	0	1	10,000	10,000
San Angelo	5,000	35,000	0	0	0	0	14,000	0	1	14,000	14,000
San Antonio	4,500	35,000	0	6,000	12,000	0	6,000	0	3	24,000	12,000

(Table 33 contd)											
San Marcos	4,500	35,000	0	2,000	10,000	0	2,000	0	3	14,000	10,000
Sherman	3,000	20,000	0	0	4,000	0	4,000	0	2	8,000	4,000
Somerville Dam	3,500	25,000	0	0	4,000	0	12,000	0	2	16,000	12,000
Texarkana	3,000	15,000	0	0	0	0	2,000	0	1	2,000	2,000
Tyler	3,000	20,000	0	0	0	0	10,000	0	1	10,000	10,000
Waco	3,500	20,000	0	0	4,000	0	6,000	0	2	10,000	6,000
Wimberley	4,500	30,000	0	0	6,000	0	10,000	0	2	16,000	10,000

*Thru October

Table 34: Backup Requirements of “Right-Sized” Rainwater Harvesting Systems in Standard Subdivisions at Modeling Locations With Reduced Water Usage Rate.

House occupancy = 4 people			Water usage rate = 40 GPCD								
Modeling	Roofprint	Cistern Size	Backup Supply Required in Year						No. of years	Total	Max. year
Location	(ft ²)	(gal.)	2007	2008	2009	2010	2011	2012*	With Backup	Backup (gal.)	Backup (gal.)
Abilene	4,000	30,000	0	0	0	0	4,000	2,000	2	6,000	4,000
Athens	3,500	20,000	0	0	0	0	6,000	0	1	6,000	6,000
Austin	4,500	35,000	0	0	0	0	6,000	0	1	6,000	6,000
Beeville	4,750	35,000	0	0	4,000	0	2,000	2,000	3	8,000	4,000
Blanco	4,500	35,000	0	0	2,000	0	2,000	0	2	4,000	2,000
Boerne	4,500	35,000	0	0	6,000	0	2,000	0	2	8,000	6,000
Bowie	3,500	25,000	0	0	0	0	4,000	0	1	4,000	4,000
Brownwood	3,750	30,000	0	0	0	0	0	0	0	0	0
Burnet	4,500	30,000	0	0	0	0	2,000	0	1	2,000	2,000
Cleburne	3,500	25,000	0	0	0	0	4,000	0	1	4,000	4,000
Conroe	3,000	20,000	0	0	0	0	0	0	0	0	0
Corpus Christi	4,500	35,000	0	0	4,000	0	4,000	2,000	3	10,000	4,000
Dripping Springs	4,500	35,000	0	0	0	0	2,000	0	1	2,000	2,000
Edinburg	5,500	45,000	0	0	0	0	0	12,000	1	12,000	12,000
El Campo	3,500	25,000	0	0	0	0	6,000	0	1	6,000	6,000
Fredericksburg	4,500	40,000	0	0	0	0	6,000	0	1	6,000	6,000
Hondo	4,750	40,000	0	0	6,000	0	0	0	1	6,000	6,000
Laredo	5,500	50,000	0	0	0	0	2,000	12,000	2	14,000	12,000
Llano	4,500	35,000	0	0	0	0	2,000	0	1	2,000	2,000
Lubbock	5,500	40,000	0	0	0	0	10,000	14,000	2	24,000	14,000

(Table 34 contd)											
Lufkin-Nacogdoches	3,000	20,000	0	0	0	0	0	0	0	0	0
Marshall	3,000	20,000	0	0	0	0	0	0	0	0	0
Menard	5,000	40,000	0	0	0	0	4,000	0	1	4,000	4,000
San Angelo	5,000	35,000	0	0	0	0	4,000	0	1	4,000	4,000
San Antonio	4,500	35,000	0	0	10,000	0	2,000	0	2	12,000	10,000
San Marcos	4,500	35,000	0	0	0	0	0	0	0	0	0
Sherman	3,000	20,000	0	0	0	0	0	0	0	0	0
Somerville Dam	3,500	25,000	0	0	0	0	8,000	0	1	8,000	8,000
Texarkana	3,000	15,000	0	0	0	0	0	0	0	0	0
Tyler	3,000	20,000	0	0	0	0	6,000	0	1	6,000	6,000
Waco	3,500	20,000	0	0	0	0	2,000	0	1	2,000	2,000
Wimberley	4,500	30,000	0	0	0	0	4,000	0	1	4,000	4,000

*Thru October

Table 35: Backup Requirements of “Right-Sized” Rainwater Harvesting Systems in Seniors-Only Subdivisions at Modeling Locations.

House occupancy = 2 people (seniors oriented development) Standard water usage rate = 45 GPCD			Cistern alarm volume = 3,000 gallons (37.5 days at reduced usage rate) Enhanced conservation factor = 0.888 (reduces usage rate to 40 GPCD)								
	Roofprint	Cistern Size	Backup Supply Required in Year						No. of years	Total	Max. year
Location	(ft ²)	(gal.)	2007	2008	2009	2010	2011	2012*	With Backup	Backup (gal.)	Backup (gal.)
Abilene	2,000	15,000	0	0	0	0	8,000	4,000	2	12,000	8,000
Athens	1,750	10,000	0	0	0	0	6,000	0	1	6,000	6,000
Austin	2,500	15,000	0	0	2,000	0	8,000	0	2	10,000	8,000
Beeville	2,500	20,000	0	0	6,000	0	2,000	2,000	3	10,000	6,000
Blanco	2,500	15,000	0	2,000	4,000	0	6,000	0	3	12,000	6,000
Boerne	2,500	15,000	0	4,000	4,000	0	6,000	0	3	14,000	6,000
Bowie	2,000	10,000	0	0	4,000	0	8,000	0	2	12,000	8,000
Brownwood	2,000	15,000	0	0	4,000	0	4,000	0	2	8,000	4,000
Burnet	2,250	15,000	0	2,000	4,000	0	6,000	0	3	12,000	6,000
Cleburne	2,000	10,000	0	0	0	0	8,000	0	1	8,000	8,000
Conroe	1,500	10,000	0	0	0	0	6,000	0	1	6,000	6,000
Corpus Christi	2,500	17,500	0	0	6,000	0	6,000	2,000	3	14,000	6,000

(Table 35 contd)											
Dripping Springs	2,250	15,000	0	2,000	4,000	0	8,000	0	3	14,000	8,000
Edinburg	2,750	20,000	0	0	2,000	0	8,000	8,000	3	18,000	8,000
El Campo	2,000	10,000	0	0	0	0	8,000	0	1	8,000	8,000
Fredericksburg	2,250	20,000	0	0	0	0	8,000	0	1	8,000	8,000
Hondo	2,750	20,000	0	0	6,000	0	2,000	0	2	8,000	6,000
Laredo	3,000	25,000	0	0	0	0	6,000	6,000	2	12,000	6,000
Llano	2,500	15,000	0	0	4,000	0	8,000	0	2	12,000	8,000
Lubbock	3,000	20,000	0	0	0	0	8,000	6,000	2	14,000	8,000
Lufkin-Nacogdoches	1,500	10,000	0	0	0	0	4,000	0	1	4,000	4,000
Marshall	1,500	10,000	0	0	0	0	6,000	0	1	6,000	6,000
Menard	2,500	20,000	0	0	0	0	8,000	0	1	8,000	8,000
San Angelo	2,500	20,000	0	0	0	0	8,000	0	1	8,000	8,000
San Antonio	2,500	20,000	0	2,000	6,000	0	2,000	0	3	10,000	6,000
San Marcos	2,500	15,000	0	4,000	2,000	0	2,000	0	3	8,000	4,000
Sherman	1,750	10,000	0	0	2,000	0	2,000	0	2	4,000	2,000
Somerville Dam	2,000	12,500	0	0	0	0	8,000	0	1	8,000	8,000
Texarkana	1,500	7,500	0	0	0	0	4,000	0	1	4,000	4,000
Tyler	1,500	10,000	0	0	0	0	8,000	0	1	8,000	8,000
Waco	1,750	10,000	0	2,000	2,000	0	4,000	0	3	8,000	8,000
Wimberley	2,250	15,000	0	2,000	4,000	0	8,000	0	3	14,000	8,000

*Thru October

Table 36: Backup Requirements of “Right-Sized” Rainwater Harvesting Systems in Seniors-Only Subdivisions at Modeling Locations with Reduced Water Usage Rate.

House occupancy = 2 people (seniors oriented development)			Water usage rate = 40 GPCD								
	Roofprint	Cistern Size	Backup Supply Required in Year						No. of years	Total	Max. year
Location	(ft ²)	(gal.)	2007	2008	2009	2010	2011	2012*	With Backup	Backup (gal.)	Backup (gal.)
Abilene	2,000	15,000	0	0	0	0	4,000	0	1	4,000	4,000
Athens	1,750	10,000	0	0	0	0	4,000	0	1	4,000	4,000
Austin	2,500	15,000	0	0	0	0	6,000	0	1	6,000	6,000
Beeville	2,500	20,000	0	0	0	0	0	0	0	0	0
Blanco	2,500	15,000	0	0	2,000	0	4,000	0	2	6,000	4,000
Boerne	2,500	15,000	0	0	4,000	0	4,000	0	2	8,000	4,000
Bowie	2,000	10,000	0	0	2,000	0	4,000	0	2	6,000	4,000

(Table 36 contd)											
Brownwood	2,000	15,000	0	0	0	0	0	0	0	0	0
Burnet	2,250	15,000	0	0	0	0	4,000	0	1	4,000	4,000
Cleburne	2,000	10,000	0	0	0	0	4,000	0	1	4,000	4,000
Conroe	1,500	10,000	0	0	0	0	0	0	0	0	0
Corpus Christi	2,500	17,500	0	0	2,000	0	2,000	2,000	3	6,000	2,000
Dripping Springs	2,250	15,000	0	0	0	0	6,000	0	1	6,000	6,000
Edinburg	2,750	20,000	0	0	0	0	4,000	6,000	2	10,000	6,000
El Campo	2,000	10,000	0	0	0	0	4,000	0	1	4,000	4,000
Fredericksburg	2,250	20,000	0	0	0	0	4,000	0	1	4,000	4,000
Hondo	2,750	20,000	0	0	0	0	0	0	0	0	0
Laredo	3,000	25,000	0	0	0	0	6,000	6,000	2	12,000	6,000
Llano	2,500	15,000	0	0	0	0	4,000	0	1	4,000	4,000
Lubbock	3,000	20,000	0	0	0	0	8,000	6,000	2	14,000	8,000
Lufkin- Nacogdoches	1,500	10,000	0	0	0	0	0	0	0	0	0
Marshall	1,500	10,000	0	0	0	0	2,000	0	1	2,000	2,000
Menard	2,500	20,000	0	0	0	0	4,000	0	1	4,000	4,000
San Angelo	2,500	20,000	0	0	0	0	0	0	0	0	0
San Antonio	2,500	20,000	0	0	2,000	0	0	0	1	2,000	2,000
San Marcos	2,500	15,000	0	0	2,000	0	0	0	1	2,000	2,000
Sherman	1,750	10,000	0	0	0	0	0	0	0	0	0
Somerville Dam	2,000	12,500	0	0	0	0	4,000	0	1	4,000	4,000
Texarkana	1,500	7,500	0	0	0	0	2,000	0	1	2,000	2,000
Tyler	1,500	10,000	0	0	0	0	6,000	0	1	6,000	6,000
Waco	1,750	10,000	0	0	0	0	2,000	0	1	2,000	2,000
Wimberley	2,250	15,000	0	0	0	0	4,000	0	1	4,000	4,000

***Thru October 2012**

XI. Subdivision-Scale Rainwater Harvesting Toolbox

Description

A compilation of key information and outcomes within the investigation of Rainwater Harvesting at the Subdivision-wide scale.

Audiences

The outcomes of this investigation on rainwater harvesting as a water supply strategy for Central Texas and Hill Country developments will be of interest to numerous groups:

- Developers & Land planners
- Engineers
- Architects and builders
- Public sector, including Municipal and County Planning Departments and Regulatory agencies
- Banking, mortgage and financial community
- Real estate community including appraisal companies/individuals

Toolbox Elements

(delivered electronically via the Web and CD/DVD):

- Executive Summary of Research project
- Draft Press Release
- FACTS of study
- Summary Video
- The Modeling tool used for project activities
- Project reports for:
 - Regulatory issues
 - Back Up Strategies
 - Hydrologic Modeling

- Cost Analysis
- Marketability
- Sustainability

XII. Conclusions and Recommendations

This project investigated several facets of primarily residential-scale rainwater harvesting systems to develop a water supply strategy for whole developments. This strategy envisions collecting rainwater from building roofs and routing it to a cistern, perhaps integrated into the structure of each building, but certainly associated with that building (e.g., a free-standing cistern on the same lot). Each building, or a cluster of buildings for a commercial center or housing on a condo lot, would incorporate a self-contained water supply system, including all facilities required to filter/treat/disinfect the water enabling supply for all water demands within and around the building(s). However, all buildings may be connected to a development-wide water system through a backup supply scheme. This strategy may also include arrangements for all building-scale facilities to be maintained collectively by a management entity.

The primary focus area was the Texas Hill Country, with the initial round of examination considering the case in Austin, Boerne, Blanco, Burnet, Drippings Springs, Fredericksburg, Menard, San Marcos, and Wimberley. The applicability of this water supply concept to other parts of Texas was also reviewed.

A modeling exercise was conducted to determine sizes of system components (i.e. roof print area; cistern volume for adequate supply capacity during times of drought). This information made it possible to derive the expected costs of implementing this water supply strategy. The potential for impacts on watershed hydrology of sequestering rainwater in these residential-scale systems was also evaluated. A variety of stakeholder input was also included, and the status of governmental regulations and regulatory frameworks was reviewed to the maximum extent. Cost effectiveness and sustainability parameters also were investigated, as were the current understanding and needs for marketability of this strategy.

The building-scale RWH water supply strategy investigated in this project is identical in concept to all our conventional water supply systems, which are also rainwater harvesting systems. In those systems, which may be termed large-scale RWH systems, the collection area is the whole watershed, and the cistern is a reservoir, aquifer and/or run of the river. Only a minor fraction of the total rainfall onto the watershed typically enters the cistern and is available to meet human water demands, while close to 100% of the water falling on the building roof can be collected and stored for future use with the building-scale RWH.

This greater efficiency is well illustrated by contrasting the condition of building-scale RWH systems in the Hill Country with the reservoirs in that area, Lakes Travis and Buchanan. These reservoirs to be drawn down to near-record low levels during the drought of 2010-2011 and, despite some relief from the drought in 2012, they have not recovered.

The model indicates however, that building-scale RWH systems did recover. This indicates the rainfall that was received was sufficient to recover the building-scale systems because of their high capture efficiency, while it was not sufficient to create enough runoff generally over the watershed to recover those reservoirs.

This high efficiency is only one reason to consider building-scale RWH systems as a development-wide water supply strategy for new subdivisions in areas not already served by a water supply system. Others include:

- The long-term sustainability of groundwater is questionable in some Hill Country areas, so this water resource may not support continuing development in those areas. Further, the existing reservoirs are being stressed, therefore unlikely to support continuing development. This would result in the need for long-distance water transfers from distant aquifers and/or desalinization as the available sources of new water supply in those areas, each of which would be relatively expensive, therefore considerably increasing water rates. Under such circumstances, the building-scale RWH strategy may prove to be the globally most cost-efficient strategy;
- Although the initial cost per gallon incurred may be higher, the building-scale rainwater harvesting facilities are relatively small incremental investments requiring only the financial resources needed to serve development actually being installed. The short-term cost efficiency for the developer may be compelling in view of the minimized up-front costs.
- The time value of money over the long term may also favor a pay-as-you-go strategy. The large-scale infrastructure is an “all-or-none” decision requiring a large investment in advance of *any* delivery of service, thereby financing large-scale facilities that would not be fully utilized for many years. All system users, however, would be paying the cost of the unused facilities throughout that period;
- The rural location of the projects, combined with future fuel transport cost uncertainties, and general uncertainty about the real estate market, the developer and/or system users would have to pay back a large up-front investment with short revenues if build-out does not proceed as anticipated, thereby possibly drastically increasing the customer base water rates or taxes.;
- The cost and timing of the large-scale infrastructure installation, requiring planning and coordination by multiple jurisdictions and agencies, is typically out of the control of the developer or the eventual users, as would be the cost of water obtained from that system. In contrast, the cost and timing of the building-scale facilities are within the users’ control, and the on-going water costs would be low and not prone to escalation;
- Treatment problems, line breaks, etc., in the large-scale system could have broad ranging impacts and unpredictable user costs. In the building-scale system, any problems would be isolated and amenable to remediation by individual users and/or the local operating entity, thereby making the latter more reliable than a large-scale system;
- Building-scale rainwater harvesting is an inherently more sustainable strategy for water resources management than other options, since the development could largely be sustained with the precipitation falling within it. This aspect would engender a conservation ethic, stimulating pursuit of efficiency strategies that may not initially appear cost-effective once a large cost is expended for a piped water system;

- The water supply from a building-scale rainwater harvesting system may be of higher quality than that obtained through a piped water system. Rainwater is soft and generally of high quality. In contrast, there is little control over the collection area in large-scale systems, resulting in stored water of random quality, containing pesticides, fertilizers and/or other pollutants contributed by overland flow, and requiring pre-treatment to attain potable quality; and
- A large-scale water treatment system with a widespread distribution system entails demands for increasingly expensive energy. A point-of-use treatment and pressurization system would demand less energy, thereby having lower operating costs and greater sustainability.

The major difference between the large-scale and building-scale RWH systems is the former typically has a very large storage capacity, relative to the usage drawn from it. A building-scale system would typically have a rather limited storage capacity, thereby possibly requiring a backup water supply during drought periods. This can readily be arranged, assuming the large-scale systems from which backup supplies would be drawn have the capacity to provide that supply, making the size of the storage capacity vs. the cost of more or less frequent requirements for backup supply, a major factor in determining cistern capacity. Also important is consideration what other capacity limitations the backup supply system might have.

For the foreseeable future, the predominant mode of backup supply would be hauling water to the building-scale cisterns in tanker trucks. While the current fleet of tanker trucks appears to be able to provide sufficient capacity for a considerable number of new rainwater harvesters in most cases, with broadscale proliferation of the building-scale RWH strategy, the ability of the available fleet of tanker trucks in any given area could become strained. This introduces the concept of “right-sizing” the building-scale RWH systems to limit the quantity of backup water supply required for the expected worst-case drought conditions. A modeling process was used to assess this factor, based on a 25-year historic rainfall model covering the period 1987-2011.

A fortunate coincidence in this investigation is that the drought of 2010-2011 is now considered the worst single-year drought on record in this region. Thus, the backup supplies that would have been incurred in that period would represent the worst case going into future years. As noted above, in fact, although the drought has persisted in the region, subsequent modeling efforts extending through 2012 (and after the completion of this project into 2013) indicated the Hill Country building-scale RWH systems would have recovered, and no further backup supplies would be required since the drought became less severe (to some extent) in late 2011.

The right-size of RWH systems throughout most of the focus area of this investigation would require a roofprint (rainfall collection area) of 4,500 sq. ft. and a cistern capacity of 35,000 gallons. That roofprint is in the range of 1,000 sq. ft. larger than expected for a 1-story 3-4 bedroom houses plus garage and covered patio/porch areas.

How to most cost-effectively provide this additional roofprint requires further investigation. This topic has been labeled the “veranda strategy,” meaning surrounding a

house with covered patios/porches or verandas, to provide that roofprint, which may represent a template for a “Hill Country rainwater harvesting vernacular” building design concept. The cistern also might be cost-effectively designed into the building, perhaps being located under the extensive veranda floors, thereby not encumbering the lot with a free-standing cistern.

The above an important consideration since a developer would not likely pursue a development with the building-scale RWH strategy as the sole water supply system unless he is confident the builders could produce and market, the right-sized buildings demanded by this approach. Interestingly, this imparts a “chicken or egg” conundrum challenging the proliferation of this this strategy, since builders would have impetus to offer such designs unless there were developments for which they could market them.

The same can be said of the regulatory environment, noting a developer would also hesitant to propose such a development without knowing the regulatory requirements to be met. This entails state-level regulation by the Texas Commission on Environmental Quality (TCEQ), as well as the county level though the development platting process.

The TCEQ did confirm that individual building-scale RWH systems will continue in their currently unregulated status, unless the water system usage increased to a level that the water system became a “public water supply system.” Further, if a building served by a building-scale RWH system has a connection to a public water supply system, new regulations released after the completion of this investigation would apply to them. The impacts of these new regulations on building-scale RWH practice were beyond the scope of this investigation.

The TCEQ, however, did not provide guidance on how various other rules might be interpreted if applied to a water supply system consisting of a collection of building-scale RWH systems. These include governance of water hauling, and regulation of wells and waterlines when used only for occasional backup supply, rather than as the sole water supply system to its users -- the situation presumed by those rules. It is recommended that the TCEQ thoroughly consider if/how various rules would apply to those processes when employed only for provision of occasional backup water supply.

Regarding county-level regulation through the platting process, few counties have explicitly considered this topic. Some counties rules explicitly require water availability be assured, with a “safe and secure water supply” being available to all property buyers in a development. Many counties are curiously silent about this topic, apparently leaving actual availability of a safe and secure water supply as a ‘buyer beware’ consideration. No counties specified what this requirement would entail if the water supply strategy proposed were building-scale RWH, possibly because this topic has not yet been received attention from county governments because no developers have yet approached them proposing to plat a project with the explicit declaration that the water supply system for all the properties in it would be building-scale RWH, thereby producing another “chicken or egg” conundrum.

It may be that if a county were to require evidence of water availability, or assurance of a safe and secure water supply, it would translate into the requirement that all buildings in the development have right-sized RWH systems, that an organized, assured backup supply system would exist, and/or that organized/professionally overseen operations and maintenance of the rainwater treatment units was provided. In any case, little engagement or feedback from the county governments was obtained during this investigation, despite various attempts to obtain it. It is recommended such efforts continue, perhaps including a ‘summit meeting’ among county development coordinators and commissioners to review these matters and determine what, if any, rules specific to building-scale RWH are to be adopted.

The stakeholder responses (Rainwater Forum and marketing focus group) indicated a significant degree of manifest interest in considering the building-scale RWH water supply strategy. Further such outreach to the various groups of stakeholders is recommended to refine approaches to regulation, building design, financing, backup supply strategies, etc.

As previously noted, investigation of backup supply capacity among existing private sector water haulers, at least where covered by haulers who responded to requests for input, indicated the haulers would be able to accommodate considerable growth in the market. It is expected, however, that this capacity would be exhausted at some point if the building-scale RWH strategy were to proliferate. That point would depend on the willingness and ability of haulers to expand their capacities, on the willingness and ability of new haulers to enter the market, and on the location of the developments using the building-scale RWH strategy, relative to the water sources used by haulers obtain the backup water supplies.

The options to water hauling for backup supply would rely on localized water sources, such as private wells, or a community well utilized solely to provide a backup water supply. Challenges to such strategies would be the continuing availability of local water sources, particularly the sustainability of Hill Country aquifers, as well as governance issues if they are to be used solely for occasional backup supply, rather than as the sole water supply source.

Further investigation of such matters is recommended. The existing/readily developable capacity in areas not covered by the water haulers responding to this investigation, for example, must be established. The backup water supply sources also need to be reviewed to determine their sustainability for supplying ever-increasing water volumes, particularly where those water sources would be most challenged by drought conditions. Further, the rules applicable to both water hauling, and wells and waterlines when used only for occasional backup supply rather than as sole water sources, must be clarified, and/or new rules developed to explicitly address this situation.

An often-expressed concern about broadly implementing building-scale RWH over a watershed is the impact on the watershed hydrology of sequestering all the roof runoff in on-site cisterns. The concern is whether or not it would reduce runoff in the watershed that would otherwise contribute to downstream water supplies, thereby perhaps also causing water rights issues. This investigation, conducted from the perspective of individual rooftops to an entire watershed, suggests no such issues would arise.

Landform changes, and the addition of impervious surfaces other than roofs, along with cistern overflows, would result in an overall increasing post-development annual runoff, despite the roof runoff being withheld from quickflow runoff. Nevertheless, the captured water does not exit the watershed; rather, a large portion would appear as wastewater flow after first being used in the building. Depending on the type of wastewater management system, this may provide a more uniform contribution to baseflow, rather than increasing quickflow, which may actually be beneficial to downstream water usage. It is suggested the issue of reducing already committed water supplies merits further investigation.

As development intensity increases, however, the increased quickflow runoff caused by development becomes larger. Various storm water management practices are required to combat the resulting hydrologic disruption. Withholding quickflow runoff from rooftops may decrease the need for those practices, perhaps rendering them more effective in maintaining pre-development hydrology. Further investigation of the interplay of building-scale RWH and stormwater management is recommended, along with considering that rules may perhaps be modified to recognize the contribution to this function provided by a broadscale practice of building-scale RWH.

The cost effectiveness of the building-scale RWH strategy, relative to other forms of providing water supply to any given development, also requires further refinement. The cost analyses conducted in this investigation indicate building-scale RWH will invariably incur a higher initial capital cost than the other immediately-available options, including a private well, a community well and distribution system within the development, and extending a transmission main from an existing water supply system and installing a distribution system within the development. The options of long-distance water transfer into the area or desalination were not explicitly evaluated, but are expected to incur high upfront costs and relatively high ongoing O&M costs because of the energy-intensive nature of these options. These evaluations include several caveats, particularly the availability of groundwater or piped water to any particular development site.

The implications of the broadscale practice of building-scale RWH on sustainability were also reviewed. The sustainability of local and downstream water supplies was first considered. The high efficiency of building-scale rainwater harvesting in converting rainfall into usable water supply allows it to provide that supply without drawing down vulnerable aquifers or decreasing the quantity of runoff from most sites after development, compared to the quantity of runoff from the site prior to development, thereby contributing to the overall sustainability of locally-available water supply without compromising downstream water supply capacity.

Also noted is the ability of building-scale RWH to sustain development in areas where local groundwater is under stress and not expected to service continuing development. Building-scale RWH in such cases may actually render development more cost-effective. An example is the area of Hays County where the Hays-Trinity Aquifer is the sole local water supply source. The limitations of this supply have caused Hays County to require a minimum lot size of 6 acres in that area. By using building-scale RWH systems as an alternative, lots as small as 1 acre can be platted in that area, thereby also contributing to the sustainability of continuing development in some circumstances.

By substituting site-harvested rainwater for imported water supplies, building-scale RWH in the Hill Country also can enhance the sustainability of the water supply in the area from which the water would be imported. Citizens in some areas where local aquifers are targeted as the source for water transfer schemes are opposing those transfers under the perception this practice may be limiting or damaging the health well-being of the local economy. While long-distance water transfer schemes may go forward, limiting their extent by substituting building-scale RWH for imported water systems in parts of the Hill Country may limit the extent that water resources in the source area would be compromised.

Another aspect of sustainability is the lower energy demand by a building-scale RWH system, relative to other options. The energy costs to move water through an extensive distribution system and/or lift it out of a well would be significantly higher than lifting it out of a cistern and distributing it throughout the building. Noting it takes water to make energy in most cases (the “water-energy nexus”), then reducing energy demands also conserves water, further enhancing water supply sustainability.

Also reviewed was how building-scale RWH can contribute to reducing hydrology changes attributable to development, which can in turn enhance the sustainability of the local hydrologic regime. The interplay of these functions is a recommended area of further investigation.

Building-scale RWH contributes to, and raises awareness of, integrated water management, a concept whereby each component of our water resources infrastructure is part of a holistic system, in contrast to each of the water management functions – water supply, stormwater management, and wastewater management – being addressing in isolation. Integrating management systems can significantly enhance the overall efficiency of water use, enhancing the sustainability of water supplies.

As noted previously, this investigation extended modeling activities to cover a much larger area than the Hill Country, in order to illustrate the utility of this strategy in other parts of Texas. It was found the building-scale RWH strategy generally would be more viable in areas north and east of the Hill Country, rather than in the Hill Country itself. Thus, the roofprint and cistern volume required to right-size a system would be smaller and less expensive to install. Warranting further study is identifying the drivers of using building-scale vs. the conventional water supply options in those areas. As one goes to the western parts of Texas and into the Lower Rio Grande Valley, the large roofprints and cisterns required to right-size a system there make the practice less feasible.

Further investigations are recommended to more fully understand and evaluate the merits of using building-scale rainwater harvesting systems as the sole water supply form over entire developments, rather than instituting a conventional strategy. Further recommended investigation, in no particular order of priority, include:

- Defining building-scale treatment units that qualify for use in a public water supply system, and determining how to address this issue within the TCEQ perspective. This

issue is currently only subject to review as an exception approval. Thus, there is a need to draft and promulgate rules specific to building-scale RWH.

- Defining platting requirements for developments that will use RWH exclusively as the water supply strategy. There is a need for water availability standards, and defining what constitutes a “safe and secure water supply” that is specific to RWH, and subsequently get each jurisdiction to explicitly consider these requirements in determining any platting requirements versus what will be left to a ‘buyer beware’ perspective.
- Defining the cost-effectiveness of building-scale RWH vs. large-scale, long-distance water importation schemes. The Wimberley Valley seems to be a prime candidate for such an evaluation.
- Defining the interrelations between of RWH and stormwater management goals, and creating model rules.
- Defining a standard treatment unit, and an appropriate standard O&M protocol, for a building-scale RWH system that is not a public water supply system.
- Formulating the concept of water-independent commercial buildings/campuses.
- Formulating Hill Country rainwater harvesting vernacular house designs, including establishing projects with architects and/or the UT architecture school.
- Expanding the analysis of the capacity of existing backup supply water haulers, and ability of new haulers to enter the market, particularly vis-à-vis TCEQ regulatory requirements for water hauling, and how they apply to the provision of a backup supply dumped into a cistern that would be classified as non-potable water if that RWH system were a regulated system.
- Surveying existing RWH practitioners regarding the degree of satisfaction with cost/value, water quality, water use (restrictions), O&M, etc., and clarifying practices required to assure good service.
- Investigating fire protection requirements, and how they can be addressed within the context of building-scale RWH systems.

The toolbox created for this project will assist a range of stakeholders, including builders, lenders, and regulatory entities in furthering their knowledge about the viability of the recommended water supply strategy. Several builders and developers expressed interest in the project during its duration, and it is anticipated that strengthening these relationships will result in increased knowledge and available resources.

As a direct result of these efforts, the official stakeholder committee for the Cypress Creek Project, which is a TCEQ- and United States Environmental Protection Agency (USEPA)-funded effort, has adopted the initial findings of this study in their watershed protection plan. This project will continue investigations of residential-scale rainwater harvesting over whole developments as a best management practice for watershed and water quality protection for the Wimberley and Woodcreek area. As another TCEQ- and USEPA-funded watershed protection project launches in the San Marcos area (Upper San Marcos Watershed), it is expected stakeholders and research staff will review the findings from this study, and may adopt aspects of this water supply strategy as a best management practice for implementation in their watershed.

Another result of activities undertaken in this investigation is a collaboration between study authors and The University of Texas' Plan II Undergraduate program. Plan II students and faculty will utilize the recommendations from this project, beginning in late-January, to collect additional information and address knowledge gaps with respect to policy aspects and implementation of residential-scale rainwater harvesting as a development-wide water supply strategy. All findings will be shared with the TWDB.

Conclusions from this project and recommendations for additional research are summarized below, and additional findings and recommendations are available in Appendix P.

Literature Cited

Butler, K.S., A. Karvonen, U. Desai, S. Price and Jonathan Ogren. 2004. Integrative Water Management and Conservation Development: Alternatives for the Texas Hill Country. <http://hillcountryalliance.org/uploads/HCA/IntergrativeWaterManagement.pdf> (accessed September 2013).

City of Austin. Drainage Criteria Manual. [http://austintech.amlegal.com/nxt/gateway.dll/Texas/drainage/Cityofaustintexasdrainagecriteriamanual?=/templates\\$fn=default.htm\\$3.0\\$vid=amlegal:austin_drainage\\$anc=](http://austintech.amlegal.com/nxt/gateway.dll/Texas/drainage/Cityofaustintexasdrainagecriteriamanual?=/templates$fn=default.htm$3.0$vid=amlegal:austin_drainage$anc=). (accessed February 01, 2012).

EPA BASINS 2007. BASINS (Better Assessment Science Integrated point & Non-point Sources). <http://water.epa.gov/scitech/datait/models/basins/index.cfm> (accessed December 10, 2012).

EPA-HSPF 2007. Exposure Assessment Models. <http://www.epa.gov/ceampubl/swater/hspf/> (accessed December 10, 2012).

GenScn 2008. GENERation and analysis of model simulation SCeNarios. <http://water.usgs.gov/software/GenScn/> (accessed December 10, 2012).

Lake Austin Blog. April 17, 2012. Finding New Ways to Store Texas Water <http://www.lakeaustinblog.com/finding-new-ways-to-store-texas-water/>.

The Meadows Center for Water and the Environment. 2012. Assessment of the Economic Contribution of Cypress Creek to the economy of Wimberley, Phase II Final Report - <http://www.txhillcountrywater.org/> (accessed December 10, 2012; updated 2013 version available).

Slade, R.M., Jr., M.E. Dorsey, and S.L. Stewart. 1986. Hydrology and water quality of Barton Springs and associated Edwards aquifer in the Austin area, Texas: U.S. Geological Survey Water-Resources Investigations Report 86-4036, 117 p. <http://pubs.er.usgs.gov/pubs/wri/wri864036>

Woodruff, C.M., Jr. and R.M. Slade. 1984. Austin Geological Society Guidebook. Hydrogeology of the Edwards Aquifer, Barton Springs Segment: Water-budget analysis for the area contributing recharge to the Edwards Aquifer, Barton Springs Segment. No. 6, p. 36-42.

Appendix A – Rainwater Harvesting Modeling Reviews

Review of Modeling Results

The modeling results and their implications for the right-sizing of RWH facilities – roofprint and cistern capacity – are reviewed below for each of the modeling locations in alphabetical order. The first review, for Austin, offers an expanded information that provides insights into how radically the conditions in the 2010-2011 drought period (reflected in the modeling summaries as backup supply requirements in 2011) control right-sizing, requiring upsizing of the facilities needed to cover 2011, while all other conditions could be covered with smaller facilities. Given the outlier nature of the 2010-2011 period, it is to be expected that doing this would fairly well assure that the facilities would be right-sized for any foreseeable future conditions, despite the prospects for continuing drought conditions in this region. For the rest of the locations, a less expansive review is offered, highlighting conditions under which each configuration evaluated may be considered the right-sized RWH facilities for that scenario.

Austin

In Austin and vicinity, the severe conditions encountered in the 2010-2011 drought period strongly control the right-sizing of RWH facilities. The modeling summaries for Austin are displayed in Appendix B.

2-Person Occupancy, Interior Usage Only

Two model runs for 2-person occupancy were executed. One presumes a roofprint of 2,500, and the other presumes a roofprint of 3,000 ft², each in combination with a 15,000-gallon cistern. The 2,500 ft² roofprint would suffice to cover even the record low rainfall conditions of 2010-2011 if the average demand were controlled at 40 GPCD. It would also suffice under the curtailment scenario. In that case, the routine usage rate of 50 GPCD would be curtailed to 35 GPCD whenever the cistern volume dropped below 3,000 gallons (30 days usage by 2 people at a usage rate of 50 GPCD). Model results show 8,000 gallons of backup supply would have been required in 2011 under this curtailment scenario.

Examining the 2011 model, one 2,000-gallon tanker truck load per month would have been required from June thru September, a period over which only 0.41 inches of rain had fallen – a *very* severe condition, as Table 3 indicates. As set forth above, this is considered marginally manageable for a tanker truck backup supply system. Uncurtailed usage at 50 GPCD, or even at 45 GPCD, would incur unmanageable levels of backup supply.

Although the largest annual total of backup supply would have been only 6 truckloads – 12,000 gallons – in each case more than one tanker truckload would have been required within one month. This configuration could be considered right-sized around Austin given a sufficient degree of demand control through the critical drought periods.

With 3,000 ft² of roofprint, at a usage rate of 50 GPCD, backup supply required in 2011 would have been 10,000 gallons. Examining the 2011 model for this scenario, one 2,000-gallon tanker truck load a month would have been required from June thru October. This was a period over which only 2.35 inches of rain had fallen, shown by Table 3 to be a quite severe condition. This again would be a marginally manageable situation. The curtailment strategy would also have been marginally manageable. Controlling water usage to 45

GPCD or less would have incurred manageable levels of backup supply. This configuration would also require some degree of demand control to be considered right-sized, but to a lesser degree.

2.5-Person Occupancy, Interior Usage Only

One scenario was run for a 2.5-person average occupancy. It presumes 3,500 ft² of roofprint and a 20,000-gallon cistern. An average usage rate of 50 GPCD would have required 12,000 gallons of backup supply in 2011. Requiring 2 loads in some months, this would have been unmanageable for a tanker truck backup supply strategy. This could be considered the right size configuration of the RWH facilities if average usage rate were controlled to 45 GPCD or less, or if the curtailment strategy were practiced (with curtailment beginning in this case at a cistern volume of 3,750 gallons – 30 day supply for 2.5-person average occupancy using 50 GPCD). In either case the 2011 backup supply requirement would have been 8,000 gallons, deemed marginally manageable. To be deemed manageable, an average usage rate *below* 45 GPCD would have to be maintained, or *additional* curtailment would have to be practiced during extreme drought conditions.

3-Person Occupancy, Interior Usage Only

Two scenarios were modeled for a 3-person occupancy, both presuming a roofprint of 4,000 ft². In one scenario the cistern capacity is 20,000 gallons. Only at a usage rate of 40 GPCD might this configuration be considered right-sized, as unmanageable backup supply requirements would have occurred at higher usage rates. At 40 GPCD, the only backup supply requirement would have been 8,000 gallons in 2011, and that is considered a marginally manageable situation. With a usage rate of 50 GPCD, the 2011 requirement would have been 20,000 gallons, and at 45 GPCD, it would have been 14,000 gallons, both unmanageable for a tanker truck backup supply system. Under the curtailment scenario – in this case curtailment would begin at a cistern level of 4,500 gallons (30 day supply for 3 people using 50 GPCD) – the 2011 backup supply requirement would have been 12,000 gallons, also unmanageable. In all these cases, minimal backup supply would have been required in only one or two other years. This graphically illustrates the degree to which 2011 was the critical condition in regard to determining the right size of RWH facilities around Austin, as this configuration readily covered all other conditions within the modeling period.

The other scenario presumes a 25,000-gallon cistern. At a usage rate of 50 GPCD, the 2011 backup supply requirement would have been an unmanageable 14,000 gallons. It would have been a marginally manageable 8,000 gallons for a usage rate of 45 GPCD and under the curtailment scenario. With a usage rate of 40 GPCD, only 2,000 gallons would have been required. Given a modicum of demand control during extreme drought conditions, this configuration appears to be the right size of RWH facilities for 3-person occupancy in the Austin area. These results show how the degree of demand control exercised can reduce the size of the RWH facilities required for a manageable tanker truck backup supply strategy.

4-Person Occupancy, Interior Usage Only

Three scenarios were modeled presuming 4-person occupancy. In two scenarios, the roofprint is 4,500 ft², with cistern capacities of 35,000 gallons and 40,000 gallons,

respectively. In the third scenario, the roofprint is 5,000 ft² and the cistern capacity is 40,000 gallons. These modeling results again offer explicit insight into how very severely the sort of conditions that occurred around Austin in 2011 would control the right-sizing of a rainwater harvesting system, and how critical demand control would be in such a year.

For the scenario with 4,500 ft² of roofprint and a 35,000-gallon cistern, at a usage rate of 50 GPCD, backup supply requirements would have been manageable in all years except 2009 – when a marginally manageable 8,000 gallons would have been required – and 2011, when 22,000 gallons would have been required. Of this, 12,000 gallons would have been concentrated in two months, 3 truckloads each month, an unmanageable situation. At a usage rate of 45 GPCD, the backup supply requirement would still have been an unmanageable 12,000 gallons in 2011, with only 2,000 gallons required in one other year, 2009. Under the curtailment scenario – in this case the cistern alarm level would be 6,000 gallons (30 day supply for 4 people using 50 GPCD) – the backup supply requirement in 2011 for this configuration would still have been an unmanageable 14,000 gallons, with only one or two truckloads required in any other year. At 40 GPCD, an apparently manageable backup supply requirement of 6,000 gallons would have been incurred, but examining the details of the 2011 model, it is seen that two truckloads would have been required in one month. This is due to the extremely low 3-month minimum rainfall total of 0.02 inches that occurred in Austin in 2011. This configuration might be considered right-sized at the 40 GPCD usage rate, given provisions for dealing with that sort of outlier condition.

With 4,500 ft² or 5,000 ft² of roofprint and a cistern capacity of 40,000 gallons, the backup supply requirements would have been marginally manageable or manageable if average water usage rate were maintained at 45 GPCD or less, or under the curtailment scenario. At 45 GPCD, the 2011 backup supply requirement would have been 8,000 gallons with 4,500 ft² of roofprint and 6,000 gallons with 5,000 ft² of roofprint. Under the curtailment scenario, the 2011 backup supply requirements would have been 10,000 gallons with the 4,500 ft² roofprint and 8,000 gallons with the 5,000 ft² roofprint. With an uncurtailed usage rate of 50 GPCD, however, to hold the backup supply requirement to a manageable level in a year like 2011 would require upsizing to a roofprint of 5,500 ft² and a cistern capacity of 45,000 gallons. (This scenario is not shown in the modeling summary table). That again is the case because of the extremely low 3-month minimum rainfall total of 0.02 inches that occurred in Austin in 2011. As Table 3 shows, this was a much more severe condition than was observed at any of the other weather stations. It rules that, unless the system were upsized as noted, demand control must be exercised prior to and during such a period. Otherwise, multiple truckloads of backup supply would be required in some months, rendering a tanker truck backup supply strategy unmanageable.

It may be called to question if, being such an extreme 3-month condition within an extreme low 12-month period, this may be considered an anomaly, which could be discounted in regard to long-term viability of the RWH system. If such an extreme period were to occur again, the model results indicate it could be dealt with by adopting sufficiently disciplined demand control. Again the conundrum is knowing when to curb water use in order to get through such a period while incurring a manageable backup supply requirement. This highlights again that this is a matter to be considered in setting the policy for how to define

if the RWH facilities are right-sized so that a manageable tanker truck backup supply strategy can be reasonably assured.

High Usage Scenarios, Interior Usage Only

To evaluate the impact of more liberal water use, two scenarios were run presuming 4-person occupancy with an average usage rate of 60 GPCD. The first scenario presumes 5,500 ft² of roofprint and a cistern capacity of 50,000 gallons. The backup supply requirements would have been 4,000 gallons in 2009 and 16,000 gallons in 2011, so at this usage rate, this configuration would have been unmanageable. Under the curtailment scenario – in this case the cistern alarm level is 7,200 gallons (30 day supply for 4 people using 60 GPCD), and the curtailed usage rate is $0.7 \times 60 = 42$ GPCD – 4,000 gallons would have still been required in 2009, while the 2011 backup supply requirement would have dropped to 12,000 gallons, which is still an unmanageable level.

The other scenario presumes a roofprint of 6,000 ft² and a cistern capacity of 55,000 gallons. Backup supply would have been required only in 2011, totaling 8,000 gallons. However, 6,000 gallons of this would have been required in one month. Even with a system of this size, there would be an unmanageable backup supply situation unless water usage was curtailed during periods as critical as was 2011 around Austin. Under the curtailment scenario, the 2011 backup supply requirement would have been 4,000 gallons, but all required in one month. This again highlights how very extreme the 2011 conditions were around Austin. It would require even more curtailment to get through such a period without incurring this unmanageable situation. Given sufficient attention to demand control as required in each case during such periods, either of these configurations could be considered right-sized for this usage profile around Austin.

Requirements to Cover Irrigation Usage

Adding irrigation demands to interior usage – without practicing wastewater reuse to defray those irrigation demands – would require very high amounts of backup supply unless the RWH facilities were to be significantly upsized. An upsized system, evaluated only for the 4-person occupancy scenario, is reviewed in this section. Reviewed first are the backup supply implications of adding irrigation demands, without practicing wastewater reuse, for the scenarios that were evaluated above for interior usage only. Then the impact of practicing wastewater reuse to defray irrigation demand is reviewed. With or without wastewater reuse, under the curtailment scenarios, besides curtailing interior use as previously reviewed, irrigation usage would be stopped completely when the cistern volume dropped below the alarm level. For details on all these scenarios, see the modeling summaries for Austin in Appendix A Table A-1.

Irrigation WITHOUT Wastewater Reuse

With 2-person occupancy, to support 1,200 ft² of irrigated landscaping (600 ft² per resident, as reviewed previously) from the rainwater supply, the configuration with 2,500 ft² of roofprint would have required backup supply between 14 and 17 of the 25 years covered by the model, depending on interior usage rate. The 2011 requirement ran from 26,000 gallons with an interior usage rate of 40 GPCD to 34,000 gallons with an interior usage rate of 50 GPCD. With 3,000 ft² of roofprint, backup supply would have been required in 5-14 years, depending on interior usage rate. The 2011 requirements ranged from 22,000

gallons with an interior usage rate of 40 GPCD to 30,000 gallons with an interior usage rate of 50 GPCD. Under the curtailment scenario, the peak backup supply requirement, occurring in 2011, would have been 14,000 gallons with either roofprint. Backup supply would have been required in 17 years with the 2,500 ft² roofprint and in 12 years with the 3,000 ft² roofprint.

For the 2.5-person occupancy scenario, with 1,500 ft² of irrigated area supplied from the rainwater supply, backup supply would have been required in 6-15 years, depending on interior usage rate. The 2011 backup supply requirement would have run from 28,000 gallons with an interior usage rate of 40 GPCD to 36,000 gallons with an interior usage rate of 50 GPCD. Under the curtailment scenario, the peak backup supply, required in 2011, would have been 10,000 gallons. Some backup supply would have been required in 12 out of the 25 years in the model.

For 3-person occupancy, to supply 1,800 ft² of irrigated area from the rainwater supply, backup supply would have been required in 6-16 years, depending on interior usage rate and cistern size. The 2011 requirement ranged from 32,000 gallons at an interior usage rate of 40 GPCD with the 25,000-gallon cistern in place, to 48,000 gallons at an interior usage rate of 50 GPCD with the 20,000-gallon cistern in place. Under the curtailment scenarios, 2011 backup supply would have been 14,000 gallons with the 20,000-gallon cistern and 12,000 gallons with the 25,000-gallon cistern. Backup supply would have been required in 15 years in both cases.

Under the 4-person occupancy scenarios, to supply 2,400 ft² of irrigated area from the rainwater supply, backup supply would have been required in 6-15 years, depending on interior usage rate and system size. Without curtailment, the 2011 backup supply requirement ranged from 38,000 gallons for the largest system with an interior usage rate of 40 GPCD to 64,000 gallons for the smallest system with an interior usage rate of 50 GPCD. Under the curtailment scenarios, 2011 backup supply requirements were 16,000 to 20,000 gallons. Backup supply would have been required in 11 years for the largest system and in 15 years for the other two configurations.

One scenario, for 4-person occupancy, was modeled to show how much RWH facilities would have to be upsized in order to hold backup supply requirements to a manageable level if all irrigation usage were to be provided from the rainwater supply. This scenario presumed a roofprint of 7,500 ft² and a cistern capacity of 55,000 gallons. This is an increase of at least 2,500 ft² of roofprint and 15,000 gallons of cistern capacity above the 4-person occupancy scenarios previously reviewed. In all cases, backup supply would have been required only in 2011. If the interior water usage rate were 50 GPCD, the backup supply requirement would have been 24,000 gallons. At an interior usage rate of 45 GPCD, this would have dropped to 16,000 gallons, and at an interior usage rate of 40 GPCD, it would have been 8,000 gallons. Despite the large size of this RWH system, these are all unmanageable conditions. Again this is a testament to the extremity of the 2011 conditions, indicating that curtailment would have to be practiced during such periods.

If *only* irrigation usage were curtailed (stopped completely) when cistern volume dropped below the 6,000-gallon alarm level, the backup supply requirement in 2011 would have

been 6,000 gallons if the interior usage rate were 50 GPCD. If the interior usage rate were 45 GPCD, the model yields a requirement of 8,000 gallons. However, this is a quirk of the model. Due to the long time step employed, curtailment would not have commenced in time to prevent the model from requiring a large backup supply to cover irrigation demand in the first month of what should have been the curtailment period. In real time, the cistern alarm level could have been responded to in time, and the backup supply would likely have been only 4,000 gallons. If the interior usage rate were 40 GPCD, the 2011 backup supply requirement would have been 2,000 gallons. With appropriate curtailment, this RWH system configuration could supply irrigation and still render a tanker truck backup supply system manageable in a year such as 2011 was around Austin.

Irrigation WITH Wastewater Reuse

If wastewater reuse *were* practiced to defray irrigation demands, the increase of backup supply requirements above those required with no irrigation usage would have been zero or 2,000 gallons in all years except 2011 for all cases across all the occupancy presumptions. For 2011, this increase would have been 10,000 gallons in one case, 8,000 gallons in 3 cases, 6,000 gallons in 8 cases, 4,000 gallons in 9 cases, and 2,000 gallons in 3 cases.

Comparing these amounts to those that would have been required if wastewater reuse were *not* practiced graphically illustrates the high value to rainwater harvesters of such practice, if they wish to maintain any significant area of irrigated landscaping. As reviewed above, if a regionally-appropriate native landscape theme were to be chosen, the plants could be well maintained on just the reclaimed wastewater. With this practice, landscape irrigation would impart ***NO*** increase in backup supplies above that required by interior water usage.

For all of the curtailment scenarios, zero or 2,000 gallons of increase would have been incurred in any year. This shows that, even if reclaimed water *were* to be supplemented from the rainwater supply, with that supply curtailed *only* when the cistern dropped below the alarm level, very minimal increases in backup supply requirement would be incurred. As noted, the irrigation profile presumed would be sufficient to keep a carpet grass landscape fairly lush. This demonstrates that, if wastewater reuse were practiced, rainwater harvesters *can* support a fairly lush landscape (of the limited extents presumed in the model) without incurring high backup water requirements, as long as irrigation were curtailed whenever the cistern volume dropped to the alarm level.

Blanco

Blanco also encountered conditions similar to Austin in the 2010-2011 drought period controlled the right-sizing of RWH facilities, but to a lesser extent. The 3-month minimum experienced around Blanco was less extreme, in fact being the highest 3-month minimum among all the modeling stations. The modeling summaries for Blanco are displayed in Appendix B Table A-2.

2-Person Occupancy, Interior Usage Only

Two model runs for 2-person occupancy were executed. One presumes a roofprint of 2,500 ft², and the other presumes a roofprint of 3,000 ft², each in combination with a 15,000-gallon cistern. The 2,500 ft² roofprint would suffice to cover even the record low

rainfall conditions of 2010-2011 if the average usage were controlled at 40 GPCD. At 50 GPCD, backup supply requirement would have been a marginally manageable 8,000 gallons in 2009 and an unmanageable 12,000 gallons in 2011. At 45 GPCD, a marginally manageable backup supply of 8,000 gallons would have been incurred in 2011. Under the curtailment scenario, the 2011 backup supply requirement would have been 10,000 gallons, also considered marginally manageable. For this configuration to be considered right-sized, sufficient demand control would have to be practiced during the critical drought periods.

With 3,000 ft² of roofprint, this RWH system would be right-sized for all usage rates modeled, including the curtailment scenario. At a usage rate of 50 GPCD, however, this system configuration would be considered marginally manageable, as it would require a tanker truckload per month for four consecutive months in 2011. Again, sufficient demand control would be required during critical drought periods.

2.5-Person Occupancy, Interior Usage Only

One scenario was run for a 2.5-person average occupancy, presuming a 3,500 ft² roofprint and a 20,000-gallon cistern. At a usage rate of 50 GPCD, 10,000 gallons of backup supply would have been required in 2011. Requiring two truckloads in one month, this would be deemed unmanageable. This configuration would be the right sized if average usage rate could be controlled to 45 GPCD (or less), or if the curtailment strategy were practiced.

3-Person Occupancy, Interior Usage Only

Two scenarios were modeled for 3-person occupancy, both with a roofprint of 4,000 ft². In one scenario the cistern capacity is 20,000 gallons. With this configuration, unmanageable backup supply requirements would have been incurred in 2011 for all cases except an average usage rate of 40 GPCD. At 50 GPCD, an unmanageable 16,000 gallons would have been required, along with 8,000 gallons in 2008 and 10,000 gallons in 2009. At 45 GPCD, 10,000 gallons would have been required in 2011. These conditions would be considered marginally manageable. Under the curtailment scenario, the 2011 backup supply requirement of 8,000 gallons would also be marginally manageable. Significant demand control would have to be practiced during the critical drought periods to render this system configuration right-sized.

The other scenario presumes a 25,000-gallon cistern. In this case, the 2011 backup supply requirement, at 12,000 gallons, would have been unmanageable with a usage rate of 50 GPCD, but the modeling results show this configuration to be right-sized for all other usage profiles. This is a good illustration of how demand control can reduce the size, and thus the cost, of the RWH facilities required to ensure a manageable tanker truck backup supply strategy.

4-Person Occupancy, Interior Usage Only

Three scenarios were modeled presuming 4-person occupancy. In two scenarios, the roofprint is 4,500 ft², with cistern capacities of 35,000 gallons and 40,000 gallons, respectively. In the third scenario, the roofprint is 5,000 ft² and the cistern capacity is 40,000 gallons. The modeling results for these scenarios show that the 2008-2009 drought period (reflected mainly as backup supply requirements in 2009 in the modeling results)

also controlled of the right-sizing of RWH facilities around Blanco. This repeat of drought conditions within two years indicates the necessity to right-size the RWH facilities for these conditions in order to render a tanker truck backup supply system sustainable over the long term.

The configuration with 4,500 ft² of roofprint and a 35,000-gallon cistern would be right-sized only if average water usage rate were controlled at 40 GPCD. At 50 GPCD, backup supply requirements would have been a marginally manageable 10,000 gallons in both 2006 and 2008, and they would have unmanageable at 16,000 gallons in 2009 and at 18,000 gallons in 2011. At 45 GPCD, 10,000 gallons would have been required in both 2009 and 2011. Under the curtailment strategy, the 2011 requirement would have also been 10,000 gallons. All these cases are considered to be marginally manageable. For this configuration to be considered right-sized, sufficient demand control would have to be practiced during critical drought periods.

With 4,500 ft² of roofprint and a cistern capacity of 40,000 gallons, the backup supply system would have been a marginally manageable 8,000 gallons in 2009 at a usage rate of 45 GPCD, and 8,000 gallons would also have been required in both 2009 and 2011 under the curtailment scenario. At 50 GPCD, the requirement would have been unmanageable in 2009 and in 2011, at 16,000 gallons and 12,000 gallons, respectively. This configuration could be right-sized for this occupancy around Blanco with a bit less strict demand control than the previous scenario.

With a roofprint of 5,000 ft² and a cistern capacity of 40,000 gallons, at a usage rate of 50 GPCD backup supply requirements would still have been unmanageable in 2009, at 12,000 gallons, and marginally manageable in 2011, at 8,000 gallons. Under all the other usage profiles modeled, this configuration would be right-sized for this occupancy around Blanco. In order to have held backup supply requirements to manageable levels in 2009 and 2011 with an average water usage rate of 50 GPCD, a roofprint of 5,000 ft² and a cistern capacity of 45,000 gallons would be required. (This scenario is not shown in the modeling summary table.) These scenarios again show the impact of demand control on RWH facility requirements to cover the most extreme drought conditions that occurred within the modeling period.

High Usage Scenarios, Interior Usage Only

Two scenarios were run presuming 4-person occupancy with an average usage rate of 60 GPCD to evaluate the impact of more liberal water use. The first scenario presumes 5,500 ft² of roofprint and a cistern capacity of 50,000 gallons. The backup supply requirements would have been unmanageable in 2009 and 2011, at 18,000 gallons and 12,000 gallons, respectively. Under the curtailment scenario – usage rate would be reduced to 42 GPCD whenever the cistern level dropped below 7,200 gallons – backup supply requirements would have been manageable in all years. The other scenario presumed a roofprint of 6,000 ft² and a cistern capacity of 55,000 gallons. Backup supply, at 8,000 gallons would have been marginally manageable in 2009 but manageable in 2011. Under the curtailment scenario, 2,000 gallons of backup supply would have been required only in 2009. This system would be right-sized for a 60 GPCD average usage rate with only a modicum of demand control through extreme drought periods.

Requirements to Cover Irrigation Usage

This section examines the impacts on backup supply requirements of adding on irrigation usage to the scenarios reviewed above for interior usage only; an upsized system to provide the irrigation usage while maintaining backup supply requirements within a manageable level; and the impacts on backup supply requirements of employing wastewater reuse to defray irrigation usage. Note that for the curtailment scenarios, besides curtailing interior usage as reviewed previously, irrigation usage would be stopped completely whenever the cistern volume were to drop below the alarm level. For details of all these scenarios, see the modeling summaries for Blanco in Appendix B Table A-2.

Irrigation WITHOUT Wastewater Reuse

With 2-person occupancy, to support 1,200 ft² of irrigated landscaping from the rainwater supply, the configuration with 2,500 ft² of roofprint would have required backup supply in 10-15 years, depending on the interior usage rate. The 2011 requirement ran from 22,000 gallons with an interior usage rate of 40 GPCD to 30,000 gallons with an interior usage rate of 50 GPCD. With 3,000 ft² of roofprint, backup supply would have been required in 5-13 years, depending on the interior usage rate. The 2011 requirements ranged from 22,000 gallons with an interior usage rate of 40 GPCD to 26,000 gallons with an interior usage rate of 50 GPCD. Under the curtailment scenario, the maximum backup supply requirement in any year would have been 14,000 gallons with either roofprint. Backup supply would have been required in 15 years with a 2,500 ft² roofprint and in 13 years with a 3,000 ft² roofprint.

For the 2.5-person occupancy scenario, with 1,500 ft² of irrigated area supplied from the rainwater supply, backup supply would have been required in 7-12 years, depending on interior usage rate. The quantity would have run from 24,000 gallons with an interior usage rate of 40 GPCD to 34,000 gallons with an interior usage rate of 50 GPCD. Under the curtailment scenario, the 2011 backup supply requirement would have been 12,000 gallons. Some backup supply would have been required in 11 out of the 25 years in the model.

For 3-person occupancy, to supply 1,800 ft² of irrigated area from the rainwater supply, backup supply would have been required in 12-15 years, depending on interior usage rate, with the 20,000-gallon cistern. The 2011 requirement would have ranged from 34,000 gallons with an interior usage rate of 40 GPCD to 44,000 gallons with an interior usage rate of 50 GPCD. Under the curtailment scenario, the highest amount of backup supply would have been 14,000 gallons, in 1999, and backup supply would have been required in 12 years. With the 25,000-gallon cistern, backup supply would have been required in 7-11 years, depending on the interior usage rate. The 2011 requirement would have ranged from 28,000 gallons with an interior usage rate of 40 GPCD to 40,000 gallons with a usage rate of 50 GPCD. Under the curtailment scenario, the highest amount of backup supply would have been 10,000 gallons, which occurred in 2006, 2009 and 2011. Backup supply would have been required in 10 years.

Under the 4-person occupancy scenarios, to supply 2,400 ft² of irrigated area from the rainwater supply, backup supply would have been required in 7-14 years, depending on

interior usage rate and system size. Without curtailment, the 2011 backup supply requirement ranged from 32,000 gallons for the largest system with an interior usage rate of 40 GPCD to 58,000 gallons for the smallest system with an interior usage rate of 50 GPCD. Under the curtailment scenarios, the peak-year backup supply requirements were 14,000 to 16,000 gallons. Backup supply would have been required in 13, 12, and 11 years for the three configurations modeled, from smallest to largest, respectively.

One scenario, for 4-person occupancy, was modeled to show how much RWH facilities would have to be upsized in order to hold backup supply requirements to a manageable level if all irrigation usage were to be provided from the rainwater supply. This scenario presumed a footprint of 7,500 ft² and a cistern capacity of 55,000 gallons. This is an increase of at least 2,500 ft² of footprint and 15,000 gallons of cistern capacity above the 4-person occupancy scenarios previously reviewed. If the interior water usage rate were 50 GPCD, the backup supply requirements would have been 10,000 gallons in 2009 and 18,000 gallons in 2011, an unmanageable situation. At an interior usage rate of 45 GPCD, 10,000 gallons of backup supply would have been required in 2011, a marginally manageable situation at best. At an interior usage rate of 40 GPCD, only 2,000 gallons would have been required in 2011. If *only* irrigation had been curtailed whenever cistern volume dropped below the 6,000-gallon alarm level, the backup supply requirements would have been manageable at all interior usage rates. With sufficient demand control in years like 2011, this system configuration would be right-sized for this supply scenario around Blanco.

Irrigation WITH Wastewater Reuse

If wastewater reuse *were* practiced to defray irrigation demands, the increase of backup supply requirements above those required with no irrigation usage would have been zero or 2,000 gallons in all years except 2011 for all but five cases across all the occupancy presumptions. Of those five cases, there was a 4,000-gallon increase in 2009 in four of them and 6,000-gallon increase in 2009 in the fifth case. For 2011, this increase would have been 8,000 gallons in 1 case, 6,000 gallons in 7 cases, 4,000 gallons in 10 cases, and 2,000 gallons in 6 cases. For all of the curtailment scenarios, zero or 2,000 gallons of increase would have been incurred in any year, including the critical years of 2009 and 2011.

Comparing these amounts to those that would have been required if wastewater reuse were *not* practiced graphically illustrates the high value to rainwater harvesters of such practice, if they wish to maintain any significant area of irrigated landscaping. As reviewed previously, even these small increases in backup supply could be avoided by choosing a native landscaping scheme that could survive on only the reclaimed water irrigation, or by curtailing irrigation through the more severe periods of drought, as illustrated by the results of the curtailment scenarios.

Boerne

For Boerne, the modeling results in Appendix C Table A-3 show that, in addition to 2011, 2008-2009 was also a critical period, in terms of backup supply requirements. This repeat of significant drought within two years indicates the necessity to right-size the RWH

facilities for these conditions in order to render a tanker truck backup supply system sustainable over the long term.

Person Occupancy, Interior Usage Only

Two model runs for 2-person occupancy were executed. One presumes a roofprint of 2,500, and the other presumes a roofprint of 3,000 ft², each in combination with a 15,000-gallon cistern. The 2,500 ft² roofprint would incur manageable backup supply requirements in the critical years of 2008 and 2011 only if usage rate were held down to 40 GPCD. With a usage rate of 45 GPCD, or under the curtailment scenario, this configuration would have incurred marginally manageable backup supply requirements of 8,000 gallons in these years. At 50 GPCD, the backup supply requirements would have been 10,000 gallons in each year. With 3,000 ft² of roofprint, this RWH system would be right-sized for all usage rates modeled. At a usage rate of 50 GPCD, however this configuration would have incurred a marginally manageable requirement of 8,000 gallons in 2011.

2.5-Person Occupancy, Interior Usage Only

One scenario was run for a 2.5-person average occupancy, presuming a 3,500 ft² roofprint and a 20,000-gallon cistern. At a usage rate of 50 GPCD, 10,000 gallons of backup supply would have been required in 2011. Requiring two truckloads in one month, this would be deemed unmanageable. This configuration would be the right sized if average usage rate could be controlled to 45 GPCD (or less), or if the curtailment strategy were practiced.

3-Person Occupancy, Interior Usage Only

Two scenarios were modeled for 3-person occupancy, both with a roofprint of 4,000 ft². In one scenario the cistern capacity is 20,000 gallons. At a usage rate of 50 GPCD, an unmanageable backup supply requirement would have been incurred in 2008, at 12,000 gallons, and in 2011, at 16,000 gallons, along with a marginally manageable requirement of 8,000 gallons in 2009. At 45 GPCD and under the curtailment scenario, 2011 backup supply requirements would have been marginally manageable, at 10,000 gallons and 8,000 gallons, respectively. This system could be considered right-sized with sufficient demand control during the critical drought periods.

The other scenario presumes a 25,000-gallon cistern. At a usage rate of 50 GPCD, the 2009 and 2011 backup supply requirements, at 10,000 gallons each, would have been marginally manageable, but the modeling results show this configuration to be right-sized at 45 GPCD or less, and under the curtailment scenario. This is a good illustration of how demand control can reduce the size, and thus the cost, of the RWH facilities required to ensure a manageable tanker truck backup supply strategy.

4-Person Occupancy, Interior Usage Only

Three scenarios were modeled presuming 4-person occupancy. In two scenarios, the roofprint is 4,500 ft², combined with cistern capacities of 35,000 and 40,000 gallons. Both of these configurations would be right-sized only if usage rate were held to 40 GPCD. With the 35,000 gallon cistern, at a usage rate of 50 GPCD, an unmanageable level of backup supply requirement would have been incurred in 2008, 2009, and 2011, at 14,000 gallons, 18,000 gallons and 16,000 gallons, respectively. At 45 GPCD, the 2009

requirement would have been 12,000 gallons. Under the curtailment scenario, a marginally manageable backup supply requirement of 8,000 gallons would have been incurred in 2011.

With the 40,000-gallon cistern, at 50 GPCD backup supply requirements would still have been unmanageable in 2009, at 16,000 gallons, and marginally manageable in 2008 and 2011, at 10,000 gallons in each year. At 45 GPCD, the 2009 requirement of 10,000 gallons would have been marginally manageable. Under the curtailment scenario, the 2009 requirement would have been 8,000, considered to be marginally manageable.

The third scenario presumes 5,000 ft² of roofprint and a cistern capacity of 40,000 gallons. At 50 GPCD, this configuration would have incurred an unmanageable backup supply requirement of 14,000 gallons in 2009 and a marginally manageable requirement of 8,000 gallons in 2011. If usage rate were maintained at or below 45 GPCD, or under the curtailment scenario, this configuration would have incurred manageable backup supply requirement in all years, and so could be considered right-sized for this occupancy around Boerne. At 50 GPCD, to have incurred a manageable backup supply requirement in all years, 2009 being the most critical, would require a configuration with 5,500 ft² of roofprint and a cistern capacity of 55,000 gallons. (This scenario is not shown in the modeling summary table.) This is again a graphic illustration of how demand control through critical drought periods can reduce the size of RWH facilities required to attain a manageable tanker truck backup supply system.

High Usage Scenarios, Interior Usage Only

Two scenarios were run presuming 4-person occupancy with an average usage rate of 60 GPCD to evaluate the impact of more liberal water use. The first scenario presumes 5,500 ft² of roofprint and a cistern capacity of 50,000 gallons. The backup supply requirements would have been unmanageable in 2009 and 2011, at 20,000 gallons and 10,000 gallons, respectively. Under the curtailment scenario – usage rate would be reduced to 42 GPCD whenever the cistern level dropped below 7,200 gallons – backup supply requirements would have been marginally manageable in 2009, at 8,000 gallons. The other scenario presumes a roofprint of 6,000 ft² and a cistern capacity of 55,000 gallons. Backup supply would still have been unmanageable in 2009, at 14,000 gallons, but down to only 2,000 gallons in 2011. Under the curtailment scenario, backup supply would have been manageable in all years. This system would be right-sized for a 60 GPCD average usage rate with only a modicum of demand control through extreme drought periods.

Requirements to Cover Irrigation Usage

Issues reviewed in this section include the impacts on backup supply requirements of adding on irrigation usage to the scenarios reviewed above for interior usage only; an upsized system to provide the irrigation usage while maintaining backup supply requirements within a manageable level; and the impacts on backup supply requirements of employing wastewater reuse to defray irrigation usage. Note that for the curtailment scenarios, besides curtailing interior usage as reviewed previously, irrigation usage would be stopped completely whenever the cistern volume were to drop below the alarm level. For details of all these scenarios, see the modeling summaries for Boerne in Appendix C Table A-3.

Irrigation WITHOUT Wastewater Reuse

With 2-person occupancy, to support 1,200 ft² of irrigated landscaping from the rainwater supply, the configuration with 2,500 ft² of roofprint would have required backup supply in 9-13 years, depending on the interior usage rate. The 2011 requirement ran from 20,000 gallons with an interior usage rate of 40 GPCD to 28,000 gallons with an interior usage rate of 50 GPCD. Under the curtailment scenario, backup supply would have been required in 13 years, and the maximum backup supply requirement would have been 12,000 gallons in 2011. With 3,000 ft² of roofprint, backup supply would have been required in 5-11 years, depending on the interior usage rate. The 2011 requirements ranged from 18,000 gallons with an interior usage rate of 40 GPCD to 26,000 gallons with an interior usage rate of 50 GPCD. Under the curtailment scenario, backup supply would have been required in 11 years, and the maximum backup supply requirement would have been 14,000 gallons in 2008.

For the 2.5-person occupancy scenario, with 1,500 ft² of irrigated area supplied from the rainwater supply, backup supply would have been required in 5-10 years, depending on interior usage rate. The quantity would have run from 22,000 gallons with an interior usage rate of 40 GPCD to 30,000 gallons with an interior usage rate of 50 GPCD. Under the curtailment scenario, the 2011 backup supply requirement would have been 8,000 gallons in 2009. Some backup supply would have been required in 9 out of the 25 years in the model.

For 3-person occupancy, to supply 1,800 ft² of irrigated area from the rainwater supply, backup supply would have been required in 9-14 years, depending on interior usage rate, with a 20,000-gallon cistern. The 2011 requirement would have ranged from 30,000 gallons with an interior usage rate of 40 GPCD to 42,000 gallons with an interior usage rate of 50 GPCD. Under the curtailment scenario, the highest amount of backup supply would have been 12,000 gallons, in 2008 and 2011, and backup supply would have been required in 14 years. With a 25,000-gallon cistern, backup supply would have been required in 6-10 years, depending on the interior usage rate. The 2011 requirement would have ranged from 26,000 gallons with an interior usage rate of 40 GPCD to 36,000 gallons with a usage rate of 50 GPCD. Under the curtailment scenario, the highest amount of backup supply would have been 10,000 gallons, in 2009, and some backup supply would have been required in 10 years.

Under the 4-person occupancy scenarios, to supply 2,400 ft² of irrigated area from the rainwater supply, backup supply would have been required in 4-13 years, depending on interior usage rate and system size. Without curtailment, the 2011 backup supply requirement ranged from 28,000 gallons for the largest system with an interior usage rate of 40 GPCD to 52,000 gallons for the smallest system with an interior usage rate of 50 GPCD. Under the curtailment scenarios, the peak-year backup supply requirements were 12,000 to 14,000 gallons. Backup supply would have been required in 12, 10, and 9 years for the three configurations modeled, from the smallest to the largest, respectively.

One scenario, for 4-person occupancy, was modeled to show how much RWH facilities would have to be upsized in order to hold backup supply requirements to a manageable

level if all irrigation usage were to be provided from the rainwater supply. This scenario presumed a roofprint of 7,500 ft² and a cistern capacity of 55,000 gallons. This is an increase of at least 2,500 ft² of roofprint and 15,000 gallons of cistern capacity above the 4-person occupancy scenarios previously reviewed. If the interior water usage rate were 50 GPCD, the backup supply requirements would have been 16,000 gallons in both 2009 and 2011, an unmanageable situation. At an interior usage rate of 45 GPCD, 2,000 gallons of backup supply would have been required in 2009 and 10,000 gallons would have been required in 2011, the latter a marginally manageable situation at best. At an interior usage rate of 40 GPCD, only 2,000 gallons of backup supply would have been required, in 2011 only. If only irrigation had been curtailed when cistern volume dropped below the 6,000-gallon alarm level, the backup supply requirements would have been manageable at all interior usage rates. With a usage rate of 50 GPCD, backup supply requirement in 2009 would have been 10,000 gallons, again marginally manageable at best. With sufficient demand control in years like 2009 and 2011, this system configuration would incur a manageable level of backup supply.

Irrigation WITH Wastewater Reuse

If wastewater reuse *were* practiced to defray irrigation demands, the increase of backup supply requirements above those required with no irrigation usage would have been zero or 2,000 gallons in all years except 2011 for all but 8 cases across all the occupancy presumptions. Those cases all occurred in 2009. There was a 4,000-gallon increase in six cases, a 6,000-gallon increase in one case, and an 8,000-gallon increase in one case. For 2011, this increase would have been 6,000 gallons in 5 cases, 4,000 gallons in 11 cases, and 2,000 gallons in 8 cases. For all of the curtailment scenarios, zero or 2,000 gallons of increase would have been incurred in any year, including the critical years of 2008, 2009 and 2011.

Comparing these amounts to those that would have been required if wastewater reuse were *not* practiced graphically illustrates the high value to rainwater harvesters of such practice, if they wish to maintain any significant area of irrigated landscaping. As reviewed previously, even these small increases in backup supply could be avoided by choosing a native landscaping scheme that could survive on only the reclaimed water irrigation, or by curtailing irrigation through the more severe periods of drought, as illustrated by the results of the curtailment scenarios.

Burnet

In Burnet, while the 25-year average rainfall was lower, the 2010-2011 drought period was not quite as severe as it was in the other locations so far examined. In general, smaller RWH system configurations would appear to be right-sized around Burnet. The modeling summaries for Burnet are displayed in Appendix D Table A-4.

2-Person Occupancy, Interior Usage Only

Two model runs for 2-person occupancy were executed. One presumes a roofprint of 2,500, and the other presumes a roofprint of 3,000 ft², each in combination with a 15,000-gallon cistern. With the 2,500 ft² roofprint, backup supply requirements would have been manageable in the critical year of 2011 if usage rate were held down to 45 GPCD or less, or

under the curtailment scenario. At 50 GPCD, the 2011 backup supply requirement would have been a marginally unmanageable 8,000 gallons, and it would have been manageable in all other years. With 3,000 ft² of roofprint, this RWH system would be right-sized for all usage rates modeled.

2.5-Person Occupancy, Interior Usage Only

One scenario was run for a 2.5-person average occupancy, presuming a 3,500 ft² roofprint and a 20,000-gallon cistern. This configuration would be the right-sized, having incurred a manageable amount of backup supply in all years, for all the usage rates modeled.

3-Person Occupancy, Interior Usage Only

Two scenarios were modeled for 3-person occupancy, both with a roofprint of 4,000 ft². In one scenario the cistern capacity is 20,000 gallons. At a usage rate of 50 GPCD, an unmanageable backup supply requirement of 12,000 gallons would have been incurred in 2011. Backup supply requirements would have been manageable in all other years and for all other usage rates. This configuration would be right-sized with minimal demand control in critical drought periods. The other scenario presumes a 25,000-gallon cistern. With this configuration, the backup supply requirements would have been manageable for all usage rates modeled.

4-Person Occupancy, Interior Usage Only

Three scenarios were modeled presuming 4-person occupancy. In all scenarios, the roofprint is 4,500 ft², combined with cistern capacities of 30,000, 35,000, and 40,000 gallons. With the 30,000-gallon cistern, this configuration would be right-sized only if usage rate were held to 40 GPCD. At a usage rate of 50 GPCD, the backup supply requirement would have been unmanageable in 2011, at 16,000 gallons, and marginally manageable in 2008 and 2009, at 8,000 gallons and 10,000 gallons, respectively. At a usage rate of 45 GPCD, it would have been a marginally manageable 10,000 gallons in 2011. Under the curtailment scenario, this configuration would have incurred a marginally manageable 8,000 gallons of backup supply in 2011.

With the 35,000-gallon cistern, at a usage rate of 50 GPCD, backup supply requirements would have been marginally manageable in 2009 and 2011, at 10,000 gallons and 12,000 gallons, respectively. This configuration would be right-sized for usage rates of 45 GPCD or less. Under the curtailment scenario, the backup supply requirement would have been marginally manageable in 2011 only, at 8,000 gallons.

With the 40,000-gallon cistern, at a usage rate of 50 GPCD, backup supply requirements would have been marginally manageable at 8,000 gallons in 2009 and in 2011. They would have been manageable for all other usage rates, and under the curtailment scenario. Any of these configurations could be considered right-sized with the appropriate level of demand control during the critical drought periods.

High Usage Scenarios, Interior Usage Only

Two scenarios were run presuming 4-person occupancy with an average usage rate of 60 GPCD to evaluate the impact of more liberal water use. The first scenario presumes 5,500 ft² of roofprint and a cistern capacity of 45,000 gallons. The backup supply requirements

would have been marginally manageable in 2009 and 2011, at 8,000 gallons and 10,000 gallons, respectively. Under the curtailment scenario – usage rate would be reduced to 42 GPCD whenever the cistern level dropped below 7,200 gallons – backup supply requirements would have been manageable all years. The other scenario presumes a roofprint of 5,500 ft² and a cistern capacity of 50,000 gallons. Backup supply would have been manageable in all years, as it would have been under the curtailment scenario. These configurations would be right-sized for this usage profile around Burnet, with the smaller one requiring only a modicum of demand control through the critical drought periods.

Requirements to Cover Irrigation Usage

This section reviews the impacts on backup supply requirements of adding on irrigation usage to the scenarios reviewed above for interior usage only; an upsized system to provide the irrigation usage while maintaining backup supply requirements within a manageable level; and the impacts on backup supply requirements of employing wastewater reuse to defray irrigation usage. Note that for the curtailment scenarios, besides curtailing interior usage as reviewed previously, irrigation usage would be stopped completely whenever the cistern volume were to drop below the alarm level. For details of all these scenarios, see the modeling summaries for Burnet in Appendix D Table A-4.

Irrigation WITHOUT Wastewater Reuse

With 2-person occupancy, to support 1,200 ft² of irrigated landscaping from the rainwater supply, the configuration with 2,500 ft² of roofprint would have required backup supply in 10-19 years, depending on the interior usage rate. The 2011 requirement ran from 20,000 gallons with an interior usage rate of 40 GPCD to 30,000 gallons with an interior usage rate of 50 GPCD. Under the curtailment scenario, backup supply would have been required in 17 years, and the maximum backup supply requirement would have been 14,000 gallons in 2008. With 3,000 ft² of roofprint, backup supply would have been required in 5-13 years, depending on the interior usage rate. The 2011 requirements ranged from 14,000 gallons with an interior usage rate of 40 GPCD to 24,000 gallons with an interior usage rate of 50 GPCD. Under the curtailment scenario, backup supply would have been required in 13 years, and the maximum backup supply requirement would have been 8,000 gallons in 2011.

For the 2.5-person occupancy scenario, with 1,500 ft² of irrigated area supplied from the rainwater supply, backup supply would have been required in 6-11 years, depending on interior usage rate. The quantity would have run from 18,000 gallons with an interior usage rate of 40 GPCD to 32,000 gallons with an interior usage rate of 50 GPCD. Under the curtailment scenario, the 2011 backup supply requirement would have been 10,000 gallons in 2011. Some backup supply would have been required in 11 out of the 25 years in the model.

For 3-person occupancy, to supply 1,800 ft² of irrigated area from the rainwater supply, backup supply would have been required in 13-17 years, depending on interior usage rate, with a 20,000-gallon cistern. The 2011 requirement would have ranged from 28,000 gallons with an interior usage rate of 40 GPCD to 42,000 gallons with an interior usage rate of 50 GPCD. Under the curtailment scenario, the highest amount of backup supply would have been 12,000 gallons in 2011, and backup supply would have been required in 15

years. With a 25,000-gallon cistern, backup supply would have been required in 8-11 years, depending on the interior usage rate. The 2011 requirement would have ranged from 24,000 gallons with an interior usage rate of 40 GPCD to 40,000 gallons with a usage rate of 50 GPCD. Under the curtailment scenario, the highest amount of backup supply would have been 14,000 gallons in 2011, and some backup supply would have been required in 10 years.

Under the 4-person occupancy scenarios, to supply 2,400 ft² of irrigated area from the rainwater supply, backup supply would have been required in 9-21 years, depending on interior usage rate and system size. Without curtailment, the 2011 backup supply requirement ranged from 44,000 gallons for the largest system with an interior usage rate of 40 GPCD to 64,000 gallons for the smallest system with an interior usage rate of 50 GPCD. Under the curtailment scenarios, the peak-year backup supply requirements were 12,000 to 14,000 gallons. Backup supply would have been required in 16, 17, and 14 years for the three configurations modeled, from the smallest to the largest, respectively.

One scenario, for 4-person occupancy, was modeled to show how much RWH facilities would have to be upsized in order to hold backup supply requirements to a manageable level if all irrigation usage were to be provided from the rainwater supply. This scenario presumed a roofprint of 7,000 ft² and a cistern capacity of 50,000 gallons. This is an increase of 2,500 ft² of roofprint and at least 10,000 gallons of cistern capacity above the 4-person occupancy scenarios previously reviewed. If the interior water usage rate were 50 GPCD, the backup supply requirements would have been 16,000 gallons in 2011, an unmanageable situation. At an interior usage rate of 45 GPCD, 10,000 gallons would have been required in 2011, a marginally manageable situation at best. At an interior usage rate of 40 GPCD, only 2,000 gallons of backup supply would have been required in 2011. If irrigation had been curtailed when cistern volume dropped below the 6,000-gallon alarm level, the backup supply requirements would have been manageable at a rate of 45 GPCD or less. At a usage rate of 50 GPCD, backup supply requirement in 2011 would have been 12,000 gallons, an unmanageable situation. With sufficient demand control in a year like 2011, this system configuration would incur a manageable level of backup supply.

Irrigation WITH Wastewater Reuse

If wastewater reuse were practiced to defray irrigation demands, the increase of backup supply requirements above those required with no irrigation usage would have been zero or 2,000 gallons in all years except 2011 across all the scenarios modeled. For 2011, this increase would have been 6,000 gallons in 4 cases, 4,000 gallons in 5 cases, 2,000 gallons in 14 cases, and zero in one case. For all of the curtailment scenarios, zero or 2,000 gallons of increase would have been incurred in any year.

Comparing these amounts to those that would have been required if wastewater reuse were *not* practiced graphically illustrates the high value to rainwater harvesters of such practice, if they wish to maintain any significant area of irrigated landscaping. As reviewed previously, even these small increases in backup supply could be avoided by choosing a native landscaping scheme that could survive on only the reclaimed water irrigation, or by curtailing irrigation through the more severe periods of drought, as illustrated by the results of the curtailment scenarios.

Dripping Springs

Around Dripping Springs, the conditions encountered in the 2010-2011 drought period determined the right-sizing of RWH facilities, but not to the extent they did around Austin, as the worst case conditions around Dripping Springs were not so extreme. The modeling summaries for Dripping Springs are displayed in Appendix E Table A-5.

2-Person Occupancy, Interior Usage Only

Two model runs for 2-person occupancy were executed. One presumes a roofprint of 2,500, and the other presumes a roofprint of 3,000 ft², each in combination with a 15,000-gallon cistern. The 2,500 ft² roofprint would have incurred manageable backup supply requirements in the critical year of 2011 only if usage rate were held down to 40 GPCD. At a usage rate of 50 GPCD, the 2011 backup supply requirement would have been 12,000 gallons, likely unmanageable. At a usage rate of 45 GPCD, or under the curtailment scenario, the 2011 requirement would have been marginally manageable at 8,000 gallons in 2011. With 3,000 ft² of roofprint, this RWH system would be right-sized for all usage rates modeled, except that at a usage rate of 50 GPCD, a marginally manageable 8,000 gallons would have been required in 2011. With only fairly minimal demand control, either of these configurations could be considered right-sized for the occupancy around Dripping Springs.

2.5-Person Occupancy, Interior Usage Only

One scenario was run for a 2.5-person average occupancy, presuming a 3,500 ft² roofprint and a 20,000-gallon cistern. An average usage rate of 50 GPCD would have required 10,000 gallons of backup supply in 2011. Requiring two truckloads in two consecutive months, this would be deemed unmanageable. This configuration would be the right-sized if average usage rate could be controlled to 45 GPCD (or less), or if the curtailment strategy were practiced.

3-Person Occupancy, Interior Usage Only

Two scenarios were modeled for 3-person occupancy, both with a roofprint of 4,000 ft². In one scenario the cistern capacity is 20,000 gallons. At a usage rate of 50 GPCD, an unmanageable backup supply requirement of 16,000 gallons in 2011. At 45 GPCD, the 2011 requirement would have been a marginally manageable 10,000 gallons. Under the curtailment scenario, it would have been 8,000 gallons in 2011, also considered to be marginally manageable. This configuration could be considered right-sized with a fairly minimal degree of demand control during the critical drought periods.

The other scenario presumes a 25,000-gallon cistern. At a usage rate of 50 GPCD, the 2011 backup supply requirements would have been unmanageable at 12,000 gallons. At 45 GPCD or less, and under the curtailment scenario, the modeling results show this configuration to be right-sized.

4-Person Occupancy, Interior Usage Only

Three scenarios were modeled presuming 4-person occupancy. In two scenarios, the roofprint is 4,500 ft², combined with cistern capacities of 35,000 and 40,000 gallons.

Either of these configurations would be right-sized only if usage rate were held to 40 GPCD. With the 35,000-gallon cistern, an unmanageable level of backup supply would have been incurred in 2009 and 2011, at 14,000 gallons and 18,000 gallons, respectively. At a usage rate of 45 GPCD and under the curtailment scenario, a marginally manageable 10,000 gallons of backup supply would have been incurred in 2011. This configuration could be considered right-sized with sufficient demand control during the critical drought periods.

With the 40,000-gallon cistern, a usage rate of 45 GPCD or below would have incurred a manageable level of backup supply requirement. At 50 GPCD, this configuration would have incurred an unmanageable level of backup supply in 2009 and 2011, 12,000 gallons and 14,000 gallons, respectively. Under the curtailment scenario, the backup supply requirement would have been marginally manageable in 2011, at 8,000 gallons. This configuration could be considered right-sized with a lesser degree of demand control during the critical drought periods.

The third scenario presumes 5,000 ft² of roofprint and a cistern capacity of 40,000 gallons. At 50 GPCD, this configuration would have incurred a marginally manageable backup supply requirement of 10,000 gallons in 2011. At a usage rate of 45 GPCD or less, and under the curtailment scenario, this configuration would be considered right-sized, having incurred a manageable backup supply requirement in all years.

High Usage Scenarios, Interior Usage Only

Two scenarios were run presuming 4-person occupancy with an average usage rate of 60 GPCD to evaluate the impact of more liberal water use. The first scenario presumes 5,500 ft² of roofprint and a cistern capacity of 45,000 gallons. The backup supply requirements would have been unmanageable in 2009 and 2011, at 14,000 gallons and 18,000 gallons, respectively. Under the curtailment scenario – usage rate would be reduced to 42 GPCD whenever the cistern level dropped below 7,200 gallons – backup supply requirements would have been marginally manageable in 2011, at 10,000 gallons. The other scenario presumes a roofprint of 6,000 ft² and a cistern capacity of 50,000 gallons. Backup supply would have been marginally manageable in 2011, at 10,000 gallons. Under the curtailment scenario, backup supply would have been manageable in all years. This system would be right-sized for a 60 GPCD average usage rate with only a modicum of demand control through extreme drought periods.

Requirements to Cover Irrigation Usage

This section reports the impacts on backup supply requirements of adding on irrigation usage to the scenarios reviewed above for interior usage only; an upsized system to provide the irrigation usage while maintaining backup supply requirements within a manageable level; and the impacts on backup supply requirements of employing wastewater reuse to defray irrigation usage. Note that for the curtailment scenarios, besides curtailing interior usage as reviewed previously, irrigation usage would be stopped completely whenever the cistern volume were to drop below the alarm level. For details of all these scenarios, see the modeling summaries for Dripping Springs in Appendix E Table A-5.

Irrigation WITHOUT Wastewater Reuse

With 2-person occupancy, to support 1,200 ft² of irrigated landscaping from the rainwater supply, the configuration with 2,500 ft² of roofprint would have required backup supply in 8-13 years, depending on the interior usage rate. The 2011 requirement ran from 24,000 gallons with an interior usage rate of 40 GPCD to 32,000 gallons with an interior usage rate of 50 GPCD. Under the curtailment scenario, backup supply would have been required in 12 years, and the maximum backup supply requirement would have been 12,000 gallons in 2008 and in 2011. With 3,000 ft² of roofprint, backup supply would have been required in 6-8 years, depending on the interior usage rate. The 2011 requirements ranged from 20,000 gallons with an interior usage rate of 40 GPCD to 28,000 gallons with an interior usage rate of 50 GPCD. Under the curtailment scenario, backup supply would have been required in 8 years, and the maximum backup supply requirement would have been 12,000 gallons in 2011.

For the 2.5-person occupancy scenario, with 1,500 ft² of irrigated area supplied from the rainwater supply, backup supply would have been required in 4-10 years, depending on interior usage rate. The quantity would have run from 24,000 gallons with an interior usage rate of 40 GPCD to 34,000 gallons with an interior usage rate of 50 GPCD. Under the curtailment scenario, the 2011 backup supply requirement would have been 10,000 gallons in 2008 and in 2011. Some backup supply would have been required in 8 out of the 25 years in the model.

For 3-person occupancy, to supply 1,800 ft² of irrigated area from the rainwater supply, backup supply would have been required in 8-12 years, depending on interior usage rate, with a 20,000-gallon cistern. The 2011 requirement would have ranged from 34,000 gallons with an interior usage rate of 40 GPCD to 46,000 gallons with an interior usage rate of 50 GPCD. Under the curtailment scenario, the highest amount of backup supply would have been 12,000 gallons, in 1996, 2008 and 2011, and backup supply would have been required in 11 years. With a 25,000-gallon cistern, backup supply would have been required in 4-11 years, depending on the interior usage rate. The 2011 requirement would have ranged from 30,000 gallons with an interior usage rate of 40 GPCD to 42,000 gallons with a usage rate of 50 GPCD. Under the curtailment scenario, the highest amount of backup supply would have been 10,000 gallons in 2011, and some backup supply would have been required in 10 years.

Under the 4-person occupancy scenarios, to supply 2,400 ft² of irrigated area from the rainwater supply, backup supply would have been required in 4-13 years, depending on interior usage rate and system size. Without curtailment, the 2011 backup supply requirement ranged from 34,000 gallons for the largest system with an interior usage rate of 40 GPCD to 58,000 gallons for the smallest system with an interior usage rate of 50 GPCD. Under the curtailment scenarios, the peak-year backup supply requirements were 12,000 to 16,000 gallons. Backup supply would have been required in 13, 12, and 7 years for the three configurations modeled, from the smallest to the largest, respectively.

One scenario, for 4-person occupancy, was modeled to show how much RWH facilities would have to be upsized in order to hold backup supply requirements to a manageable level if all irrigation usage were to be provided from the rainwater supply. This scenario presumed a roofprint of 7,500 ft² and a cistern capacity of 50,000 gallons. This is an

increase of at least 2,500 ft² of roofprint and 10,000 gallons of cistern capacity above the 4-person occupancy scenarios previously reviewed. If the interior water usage rate were 50 GPCD, the backup supply requirements would have been 24,000 gallons in 2011, an unmanageable situation. At an interior usage rate of 45 GPCD, 18,000 gallons would have been required in 2011, also an unmanageable situation. At an interior usage rate of 40 GPCD, 10,000 gallons of backup supply would have been required in 2011, a marginally manageable situation. If *only* irrigation had been curtailed whenever cistern volume dropped below the 6,000-gallon alarm level, the backup supply requirements would have been a marginally manageable 12,000 gallons in 2011. At a usage rate of 45 GPCD or less, a manageable level of backup supply would have been required in 2011. This configuration could be considered right-sized to provide for irrigation supply with sufficient curtailment of demand in the most extreme conditions observed over the modeling period.

Irrigation WITH Wastewater Reuse

If wastewater reuse *were* practiced to defray irrigation demands, the increase of backup supply requirements above those required with no irrigation usage would have been zero or 2,000 gallons in all years except 2011 for all but one case across all the occupancy presumptions. In that case, the increase was 4,000 gallons in 2009. For 2011, this increase would have been 8,000 gallons in one case, 6,000 gallons in 4 cases, 4,000 gallons in 11 cases, and 2,000 gallons in 8 cases. For all of the curtailment scenarios, zero or 2,000 gallons of increase would have been incurred in any year.

Comparing these amounts to those that would have been required if wastewater reuse were *not* practiced graphically illustrates the high value to rainwater harvesters of such practice, if they wish to maintain any significant area of irrigated landscaping. As reviewed previously, even these small increases in backup supply could be avoided by choosing a native landscaping scheme that could survive on only the reclaimed water irrigation, or by curtailing irrigation through the more severe periods of drought, as illustrated by the results of the curtailment scenarios.

Fredericksburg

Further to the west than all other modeling locations except Menard, Fredericksburg received a lower average rainfall than at those locations, and the 2010-2011 12-month minimum rainfall total at Fredericksburg was a very low 6.35 inches. The backup supply requirements dictated by the conditions in 2011 greatly exceeded those imparted by the conditions in any other year. The Fredericksburg modeling scenarios graphically illustrate the peaking problem for a tanker truck backup supply system, requiring upsizing of facilities just to cover this outlier year. Again, it would be a policy consideration as to how much upsizing to require vs. presuming that extraordinary measures could be instituted to assure backup supply to RWH systems if such conditions were to repeat. The Fredericksburg modeling summaries are displayed in Appendix F Table A-6.

2-Person Occupancy, Interior Usage Only

Two model runs for 2-person occupancy were executed. One presumes a roofprint of 2,500 and a cistern capacity of 15,000 gallons. This configuration would have incurred an unmanageable backup requirement in 2011 of 16,000 gallons at usage rate of 50 GPCD, and of 12,000 gallons at a usage rate of 45 GPCD. Under the curtailment scenario, an unmanageable requirement of 14,000 gallons would have been incurred in 2011. A marginally manageable requirement of 8,000 gallons would have been incurred at 40 GPCD in 2011. In all other years, the backup supply requirement would be manageable. Demand would have to be controlled at or below 40 GPCD for this configuration to be considered right-sized around Fredericksburg.

The other scenario presumes a roofprint of 3,000 ft² and a 20,000-gallon cistern. Backup supply would have been required only in 2011 in all cases. Even with this upsizing, the backup supply requirements at a usage rate of 50 GPCD would have been marginally manageable, at 10,000 gallons. In all other cases, it would have been manageable. This configuration could be considered right-sized with sufficient demand control during the critical drought periods.

2.5-Person Occupancy, Interior Usage Only

One scenario was run for a 2.5-person average occupancy, presuming a 3,500 ft² roofprint and a 20,000-gallon cistern. At a usage rate of 50 GPCD, 16,000 gallons of backup supply would have been required in 2011, and at 45 GPCD, 12,000 gallons would have been required, in either case an unmanageable situation. At 40 GPCD, the required backup supply of 8,000 gallons would have been a marginally manageable situation. Under the curtailment scenario, the 2011 backup supply requirement would have been 10,000 gallons, also considered marginally manageable. The RWH facilities would have to be upsized somewhat, or demand would have to be controlled at or below 40 GPCD for this configuration to be considered right-sized around Fredericksburg.

3-Person Occupancy, Interior Usage Only

Two scenarios were modeled for 3-person occupancy. The first presumes a roofprint of 4,000 ft² and a cistern capacity of 25,000 gallons. At a usage rate of 50 GPCD, an unmanageable backup supply requirement of 20,000 gallons would have been incurred in 2011. At 45 GPCD, the requirement would have been 14,000 gallons, and under the curtailment scenario it would have been 12,000 gallons, both considered to be unmanageable. A marginally manageable requirement of 8,000 would have been incurred at 40 GPCD. Demand would have to be controlled at or below 40 GPCD for this configuration to be considered right-sized around Fredericksburg.

The other scenario presumes a 4,500 ft² roofprint and a 25,000-gallon cistern. At a usage rate of 50 GPCD, the 2011 backup supply requirement would have been an unmanageable 18,000 gallons. At 45 GPCD it would have been 12,000 gallons, and under the curtailment scenario it would have been 10,000 gallons, both considered to be marginally manageable. Here again, sufficient demand control would have to be practiced during a repeat of the

2011 conditions, illustrating the degree to which the 2011 conditions control the right-sizing of RWH facilities around Fredericksburg.

4-Person Occupancy, Interior Usage Only

Three scenarios were modeled presuming 4-person occupancy. In all scenarios, the roofprint is 5,000 ft², with cistern capacities of 35,000 gallons, 40,000 gallons, and 45,000 gallons, respectively. With the 35,000-gallon cistern, at a usage rate of 50 GPCD, backup requirements would have been a marginally manageable 8,000 gallons in 2009 and an unmanageable 26,000 gallons in 2011. At 45 GPCD, the backup supply requirement in 2011 would still have been unmanageable, at 18,000 gallons. At 40 GPCD, it would be marginally manageable, at 8,000 gallons. Under the curtailment scenario, the 2011 requirement would be an unmanageable 14,000 gallons. Demand would have to be controlled at 40 GPCD or below for this configuration to be considered right-sized around Fredericksburg.

With the 40,000-gallon cistern, at 50 GPCD the backup requirement would have been an unmanageable 20,000 gallons. At 45 GPCD, and under the curtailment scenario, it would have been 12,000 gallons, considered to be marginally manageable. This configuration could be considered right-sized around Fredericksburg with a bit less stringent demand control during the critical drought period.

With the 45,000-gallon cistern, at a usage rate of 50 GPCD, the 2011 backup supply requirement would have been unmanageable, at 16,000 gallons. At a usage rate of 45 GPCD, and under the curtailment scenario, it would have been 8,000 gallons, considered to be marginally manageable. In this case also some degree of demand control would have to be exercised during the critical drought conditions around Fredericksburg. These scenarios highlight the degree to which the 2011 conditions dominate the right-sizing evaluations there.

High Usage Scenarios, Interior Usage Only

Two scenarios were run presuming 4-person occupancy with an average usage rate of 60 GPCD to evaluate the impact of more liberal water use. The first scenario presumed 6,000 ft² of roofprint and a cistern capacity of 50,000 gallons. The backup supply requirements would have been an unmanageable 22,000 gallons in 2011. Under the curtailment scenario – usage rate would be reduced to 42 GPCD whenever the cistern level dropped below 7,200 gallons – backup supply requirements would still have been unmanageable, at 12,000 gallons in 2011. The other scenario presumed a roofprint of 6,500 ft² and a cistern capacity of 55,000 gallons. Backup supply would still have been an unmanageable 14,000 gallons in 2011. Under the curtailment scenario, it would have been a marginally manageable 8,000 gallons. This system would be right-sized for a 60 GPCD average usage rate only with a greater degree of demand control through extreme drought periods than is presumed in this modeling process.

Requirements to Cover Irrigation Usage

This section includes reviews of the impacts on backup supply requirements of adding on irrigation usage to the scenarios reviewed above for interior usage only; an upsized system to provide the irrigation usage while maintaining backup supply requirements within a

manageable level; and the impacts on backup supply requirements of employing wastewater reuse to defray irrigation usage. Note that for the curtailment scenarios, besides curtailing interior usage as reviewed previously, irrigation usage would be stopped completely whenever the cistern volume were to drop below the alarm level. For details of all these scenarios, see the modeling summaries for Fredericksburg in Appendix F Table A-6.

Irrigation WITHOUT Wastewater Reuse

With 2-person occupancy, to support 1,200 ft² of irrigated landscaping from the rainwater supply, the configuration with 2,500 ft² of roofprint and a 15,000-gallon cistern would have required backup supply in 12-18 years, depending on the interior usage rate. The 2011 requirement ran from 28,000 gallons with an interior usage rate of 40 GPCD to 40,000 gallons with an interior usage rate of 50 GPCD. Under the curtailment scenario, the maximum backup supply requirement, incurred in 2011, would have been 20,000 gallons, and some backup supply would have been required in 16 years.

With 3,000 ft² of roofprint and a 20,000-gallon cistern, backup supply would have been required in only 4-8 years, depending on the interior usage rate, reflecting that this configuration is significantly oversized for all conditions except 2011. The 2011 requirements ranged from 20,000 gallons with an interior usage rate of 40 GPCD to 30,000 gallons with an interior usage rate of 50 GPCD. Under the curtailment scenario, the maximum backup supply requirement, incurred in 2011, would have been 8,000 gallons. Backup supply would have been required in only 4 years, again reflecting that this configuration would be well oversized for all conditions except 2011.

For the 2.5-person occupancy scenario, with 1,500 ft² of irrigated area supplied from the rainwater supply, backup supply would have been required in 8-15 years, depending on interior usage rate. The quantity would have run from 32,000 gallons with an interior usage rate of 40 GPCD to 42,000 gallons with an interior usage rate of 50 GPCD. Under the curtailment scenario, the 2011 backup supply requirement would have been 14,000 gallons. Some backup supply would have been required in 12 out of the 25 years in the model.

For 3-person occupancy, to supply 1,800 ft² of irrigated area from the rainwater supply, backup supply for the configuration with 4,000 ft² of roofprint would have been required in 7-16 years, depending on interior usage rate. The 2011 requirement would have ranged from 38,000 gallons with an interior usage rate of 40 GPCD to 52,000 gallons with an interior usage rate of 50 GPCD. Under the curtailment scenario, the 2011 backup supply requirement would have been 14,000 gallons, and backup supply would have been required in 14 years.

With a 4,500 ft² roofprint, backup supply would have been required in 5-13 years, depending on the interior usage rate. The 2011 requirement would have ranged from 34,000 gallons with an interior usage rate of 40 GPCD to 48,000 gallons with a usage rate of 50 GPCD. Under the curtailment scenario, the 2011 backup supply requirement would have been 10,000 gallons, and some backup supply would have been required in 9 years.

Under the 4-person occupancy scenarios, to supply 2,400 ft² of irrigated area from the rainwater supply, backup supply would have been required in 7-16 years, depending on interior usage rate and system size. Without curtailment, the 2011 backup supply requirement would have ranged from 44,000 gallons for the largest system with an interior usage rate of 40 GPCD to 70,000 gallons for the smallest system with an interior usage rate of 50 GPCD. Under the curtailment scenarios, the 2011 backup supply requirements were 16,000 to 20,000 gallons. Backup supply would have been required in 13, 13, and 9 years, for cistern capacities of 35,000 gallons, 40,000 gallons, and 45,000 gallons, respectively.

One scenario, for 4-person occupancy, was modeled to show how much RWH facilities would have to be upsized in order to hold backup supply requirements to a manageable level if all irrigation usage were to be provided from the rainwater supply. This scenario presumed a roofprint of 7,500 ft² and a cistern capacity of 55,000 gallons. This is an increase of 2,500 ft² of roofprint and at least 10,000 gallons of cistern capacity above the 4-person occupancy scenarios previously reviewed. If the interior water usage rate were 50 GPCD, the backup supply requirements would have been 34,000 gallons in 2011, at an interior usage rate of 45 GPCD, 26,000 gallons of backup supply would have been required in 2011, and at an interior usage rate of 40 GPCD, 18,000 gallons would have been required in 2011. These are all unmanageable for 2011, but little to no backup supply would have been required in any other year. If *only* irrigation had been curtailed whenever cistern volume dropped below the 6,000-gallon alarm level, the backup supply requirements would have been 14,000 gallons at an interior usage rate of 50 GPCD or 45 GPCD, both marginally manageable at best. At 40 GPCD, 6,000 gallons would have been required. Here again, a greater degree of demand control, or curtailment of irrigation, in years like 2011 would have to be practiced for this system configuration to incur a manageable level of backup supply under such conditions.

Irrigation WITH Wastewater Reuse

If wastewater reuse *were* practiced to defray irrigation demands, the increase of backup supply requirements above those required with no irrigation usage would have been zero or 2,000 gallons in all years except 2011 across all the occupancy presumptions. For 2011, this increase would have been 12,000 gallons in one case, 8,000 gallons in 2 cases, 6,000 gallons in 6 cases, 4,000 gallons in 11 cases, and 2,000 gallons in 4 cases. For all of the curtailment scenarios, zero or 2,000 gallons of increase would have been incurred in any year, except for a 4,000-gallon increase in one case, occurring in 2011.

Comparing these amounts to those that would have been required if wastewater reuse were *not* practiced graphically illustrates the high value to rainwater harvesters of such practice, if they wish to maintain any significant area of irrigated landscaping. As reviewed previously, even these small increases in backup supply could be avoided by choosing a native landscaping scheme that could survive on only the reclaimed water irrigation, or by curtailing irrigation through the more severe periods of drought, as illustrated by the results of the curtailment scenarios.

Menard

Further out onto the Edwards Plateau than the other modeling stations, Menard is in an area with significantly lower average rainfall, as the 25-year average listed in Table 3 shows. The size of RWH facilities required for each occupancy level increase over those derived for the other modeling locations, and the 2010-2011 12-month minimum rainfall total was a very low 5.51 inches. While the 2011 backup supply requirements did generally dictate the right-sizing of RWH facilities, Menard did not exhibit so severe a peaking problem of 2011 backup supply requirements as was observed around Fredericksburg. The Menard modeling summaries are displayed in Appendix G Table A-7.

2-Person Occupancy, Interior Usage Only

Two model runs for 2-person occupancy were executed. One presumes a roofprint of 3,000 and a cistern capacity of 15,000 gallons. At a usage rate of 50 GPCD, this configuration would have incurred a marginally manageable backup supply requirement of 8,000 gallons in 2000, and an unmanageable backup requirement of 14,000 gallons in 2011. At 45 GPCD, a 2011 backup supply of 10,000 gallons would have been required, and at 40 GPCD, it would have been 8,000 gallons, both considered marginally manageable. Under the curtailment scenario, an unmanageable requirement of 12,000 would have been incurred 2011. In all other years, the backup supply requirement would be manageable.

The other scenario presumes a roofprint of 3,000 ft² and a 20,000-gallon cistern. The 2011 backup supply requirement would have been 10,000 gallons at a usage rate of 50 GPCD, and it would have been 8,000 gallons under the curtailment scenario, both considered marginally manageable. In all other cases, backup supply requirements would have been manageable. To be the right-sized configuration for this scenario around Menard would require attention to demand control in a year like 2011. Either configuration would suffice in all other years.

2.5-Person Occupancy, Interior Usage Only

One scenario was run for a 2.5-person average occupancy, presuming a 4,000 ft² roofprint and a 20,000-gallon cistern. At a usage rate of 50 GPCD, 14,000 gallons of backup supply would have been required in 2011, an unmanageable situation. At 45 GPCD, 8,000 gallons would have been required, considered to be marginally manageable. At 40 GPCD, the required backup supply of 6,000 gallons would have been manageable. Under the curtailment scenario, the 2011 backup supply requirement would have been 4,000 gallons, also manageable. With sufficient demand control in a year like 2011, this would be a right-sized configuration for this occupancy.

3-Person Occupancy, Interior Usage Only

Two scenarios were modeled for 3-person occupancy. The first presumes a roofprint of 4,500 ft² and a cistern capacity of 25,000 gallons. At a usage rate of 50 GPCD, this scenario would have incurred a marginally manageable backup supply requirement of 10,000 gallons in 2000, and an unmanageable backup supply requirement of 18,000 gallons in 2011. At 45 GPCD, the 2011 requirement would have been unmanageable, at 12,000 gallons. Under the curtailment scenario, the 2011 requirement would have been a

marginally manageable 8,000 gallons. At a usage rate of 40 GPCD, backup supply requirements would have been manageable at 6,000 gallons.

The other scenario presumes a 4,500 ft² footprint and a 30,000-gallon cistern. At a usage rate of 50 GPCD, the 2011 backup supply requirement of 14,000 gallons would have been unmanageable, and the 2000 requirement of 8,000 gallons would have been marginally manageable. Under the curtailment scenario, the 2011 requirement was also a marginally manageable 8,000 gallons. At a usage of rate of 45 GPCD or lower, 2011 backup supply requirements would be manageable, as they would be in all other years for all the cases that were modeled. Here again, sufficient demand control would have to be practiced during a repeat of the 2011 conditions for either of these configurations to be considered right-sized for this occupancy.

4-Person Occupancy, Interior Usage Only

Three scenarios were modeled presuming 4-person occupancy. In two scenarios, the footprint is 5,500 ft², with cistern capacities of 40,000 gallons and 45,000 gallons, respectively. With the 40,000-gallon cistern at a usage rate of 50 GPCD, the backup supply requirement in both 2000 and 2011 would have been an unmanageable 20,000 gallons. At a usage rate of 45 GPCD, the 2011 backup supply requirement would have been a marginally manageable 10,000 gallons. Under the curtailment scenario, backup supply requirement would have been 10,000 in both 2009 and 2011, again considered marginally manageable. At 40 GPCD, backup supply requirements would have been manageable in all years with this configuration. It could be considered right-sized with a sufficient degree of demand control during droughts.

With a 45,000-gallon cistern, backup supply requirements would have been unmanageable in 2000 and 2011, at 16,000 gallons and 14,000 gallons, respectively. Under the curtailment scenario, they would have been marginally manageable, at 10,000 gallons in 2000 and 8,000 gallons in 2011. At a usage rate of 45 GPCD or less, they would have been manageable. This configuration also could be considered right-sized only if sufficient demand control were exercised during drought.

The third scenario increases the footprint to 6,000 ft², with a cistern capacity of 45,000 gallons. At a usage rate of 50 GPCD, the backup supply requirement in 2011 would have been an unmanageable 12,000 gallons. For all other cases modeled, the backup requirements would have been manageable, so this configuration could be considered right-sized with only a small curtailment of demand during the most severe conditions covered by the modeling period.

High Usage Scenarios, Interior Usage Only

Two scenarios were run presuming 4-person occupancy with an average usage rate of 60 GPCD to evaluate the impact of more liberal water use. The first scenario presumed 6,500 ft² of footprint and a cistern capacity of 50,000 gallons. The backup supply requirements would have been an unmanageable 22,000 gallons in both 2000 and 2011. Under the curtailment scenario – usage rate would be reduced to 42 GPCD whenever the cistern level dropped below 7,200 gallons – backup supply requirements would still have been unmanageable, at 14,000 gallons in 2000 and 12,000 gallons in 2011. The other scenario

presumed a roofprint of 7,000 ft² and a cistern capacity of 55,000 gallons. Backup supply would still have been an unmanageable 14,000 gallons in 2011, along with a marginally manageable total of 10,000 gallons in 2000. Under the curtailment scenario, the 2011 backup supply requirement would have been a marginally manageable 8,000 gallons. This system would be right-sized for a 60 GPCD average usage rate only with a slightly greater degree of demand control through extreme drought periods than is presumed in this modeling process.

Requirements to Cover Irrigation Usage

Examined next are the impacts on backup supply requirements of adding on irrigation usage to the scenarios reviewed above for interior usage only; an upsized system to provide the irrigation usage while maintaining backup supply requirements within a manageable level; and the impacts on backup supply requirements of employing wastewater reuse to defray irrigation usage. Note that for the curtailment scenarios, besides curtailing interior usage as reviewed previously, irrigation usage would be stopped completely whenever the cistern volume were to drop below the alarm level. For details of all these scenarios, see the modeling summaries for Menard in Appendix G Table A-7.

Irrigation WITHOUT Wastewater Reuse

With 2-person occupancy, to support 1,200 ft² of irrigated landscaping from the rainwater supply, the configuration with 3,000 ft² of roofprint and a 15,000-gallon cistern would have required backup supply in 13-19 years, depending on the interior usage rate. The 2011 requirement ran from 28,000 gallons with an interior usage rate of 40 GPCD to 36,000 gallons with an interior usage rate of 50 GPCD. With 3,000 ft² of roofprint and a 20,000-gallon cistern, backup supply would have been required in 8-17 years, depending on the interior usage rate. The 2011 requirements ranged from 24,000 gallons with an interior usage rate of 40 GPCD to 34,000 gallons with an interior usage rate of 50 GPCD. Under the curtailment scenario, the maximum backup supply requirement in 2011 would have been 14,000 gallons for either configuration. Backup supply would have been required in 16 years for the smaller system, and in 14 years for the larger system.

For the 2.5-person occupancy scenario, with 1,500 ft² of irrigated area supplied from the rainwater supply, backup supply would have been required in 9-15 years, depending on interior usage rate. The quantity would have run from 32,000 gallons with an interior usage rate of 40 GPCD to 44,000 gallons with an interior usage rate of 50 GPCD. Under the curtailment scenario, the 2011 backup supply requirement would have been 12,000 gallons. Some backup supply would have been required in 7 out of the 25 years in the model.

For 3-person occupancy, to supply 1,800 ft² of irrigated area from the rainwater supply, backup supply for the configuration with the 25,000-gallon cistern would have been required in 12-19 years, depending on interior usage rate. The 2011 requirement would have ranged from 40,000 gallons with an interior usage rate of 40 GPCD to 54,000 gallons with an interior usage rate of 50 GPCD. Under the curtailment scenario, the 2011 backup supply requirement would have been 16,000 gallons, and backup supply would have been required in 14 years. With a 30,000-gallon cistern, backup supply would have been required in 8-18 years, depending on interior usage rate. The 2011 requirement would have

ranged from 34,000 gallons with an interior usage rate of 40 GPCD to 52,000 gallons with an interior usage rate of 50 GPCD. Under the curtailment scenario, the 2011 backup supply requirement would have been 14,000 gallons, and some backup supply would have been required in 13 years.

Under the 4-person occupancy scenarios, to supply 2,400 ft² of irrigated area from the rainwater supply, backup supply would have been required in 7-21 years, depending on interior usage rate and system size. Without curtailment, the 2011 backup supply requirement ranged from 40,000 gallons for the largest system with an interior usage rate of 40 GPCD to 76,000 gallons for the smallest system with an interior usage rate of 50 GPCD. Under the curtailment scenarios, the 2011 backup supply requirements were 18,000 to 24,000 gallons. Backup supply would have been required in 17, 18, and 10 years for three configurations modeled, from the smallest to the largest, respectively.

One scenario, for 4-person occupancy, was modeled to show how much RWH facilities would have to be upsized in order to hold backup supply requirements to a manageable level if all irrigation usage were to be provided from the rainwater supply. This scenario presumes a footprint of 8,500 ft² and a cistern capacity of 60,000 gallons. This is an increase of at least 2,500 ft² of footprint and 15,000 gallons of cistern capacity above the 4-person occupancy scenarios previously reviewed. If the interior water usage rate were 50 GPCD, the backup supply requirements would have been 28,000 gallons in 2011. At an interior usage rate of 45 GPCD, 20,000 gallons of backup supply would have been required in 2011, and at an interior usage rate of 40 GPCD, 12,000 gallons would have been required in 2011. These are all unmanageable for 2011, but little to no backup supply would have been required in any other year. If *only* irrigation had been curtailed whenever cistern volume dropped below the 6,000-gallon alarm level, the backup supply requirements would have been 16,000 gallons at an interior usage rate of 50 GPCD, 8,000 gallons at an interior usage rate of 45 GPCD, and 8,000 gallons at an interior usage rate of 40 GPCD. The latter two are considered marginally manageable. Here again, a greater degree of demand control in years like 2011 would have to be attained for this system configuration to incur a manageable level of backup supply under such conditions. In the climatic regime around Menard, the cistern alarm level might be set at a higher volume to help attain that demand control.

Irrigation WITH Wastewater Reuse

If wastewater reuse *were* practiced to defray irrigation demands, the increase of backup supply requirements above those required with no irrigation usage would have been zero or 2,000 gallons in all years except 2011 across all the occupancy presumptions, except for five cases in 2000. In 3 of those cases, the increase was 4,000 gallons, and in 2 cases it was 6,000 gallons. For 2011, this increase would have been 8,000 gallons in 4 cases, 6,000 gallons in 6 cases, 4,000 gallons in 11 cases, and 2,000 gallons in 3 cases. For all of the curtailment scenarios, zero or 2,000 gallons of increase would have been incurred in any year, except for one case where there was a 4,000-gallon increase.

Comparing these amounts to those that would have been required if wastewater reuse were *not* practiced graphically illustrates the high value to rainwater harvesters of such practice, if they wish to maintain any significant area of irrigated landscaping. As reviewed

previously, even these small increases in backup supply could be avoided by choosing a native landscaping scheme that could survive on only the reclaimed water irrigation, or by curtailing irrigation through the more severe periods of drought, as illustrated by the results of the curtailment scenarios.

San Marcos

Around San Marcos, the 2008-2009 period was a bit more critical overall than the 2010-2011 period, despite the 12-month minimum rainfall total having fallen into the latter period. Therefore, San Marcos is unique among the modeling locations in that 2011 backup supply requirements do not typically dictate the right-sizing of RWH system facilities. The modeling summaries for San Marcos are displayed in Appendix H Table A-8.

2-Person Occupancy, Interior Usage Only

Two model runs for 2-person occupancy were executed. One presumes a roofprint of 2,500, and the other presumes a roofprint of 3,000 ft², each in combination with a 15,000-gallon cistern. The 2,500 ft² roofprint would have incurred marginally manageable backup supply requirements of 8,000 gallons in the critical years of 2008 and 2011 at a usage rate of 50 GPCD. Under all other conditions modeled, the backup supply requirements would have been manageable in all years. With 3,000 ft² of roofprint, the backup supply requirements would have been manageable in all years, so this RWH system would be right-sized around San Marcos for all usage rates modeled.

2.5-Person Occupancy, Interior Usage Only

One scenario was run for a 2.5-person average occupancy, presuming a 3,500 ft² roofprint and a 20,000-gallon cistern. Under all conditions modeled, the backup supply requirements would have been manageable in all years, so this configuration would be right-sized for this occupancy around San Marcos.

3-Person Occupancy, Interior Usage Only

Two scenarios were modeled for 3-person occupancy, both with a roofprint of 4,000 ft². In one scenario the cistern capacity is 20,000 gallons. Under this scenario, at a usage rate of 50 GPCD, backup supply requirements would have been marginally manageable at 8,000 gallons in 2008, 10,000 gallons in 2009 and 2011. Requirements would have been manageable under all other conditions modeled. The other scenario presumes a 25,000-gallon cistern. A marginally manageable backup supply requirement would have been incurred in 2008 at a usage rate of 50 GPCD. Requirements would have been manageable under all other conditions modeled. Either of these configurations would be right-sized around San Marcos with minimal demand control in the critical drought periods covered by the modeling period.

4-Person Occupancy, Interior Usage Only

Three scenarios were modeled presuming 4-person occupancy. In all scenarios, the roofprint is 4,500 ft², combined with cistern capacities of 30,000 gallons, 35,000 gallons, and 40,000 gallons, respectively. All of these configurations would be right-sized if usage rate were held to 40 GPCD, or under the curtailment scenarios.

With the 30,000-gallon cistern, at a usage rate of 50 GPCD, backup requirements would have been at unmanageable level in 2008, 2009 and 2011, at 18,000 gallons, 16,000 gallons and 14,000 gallons, respectively. At 45 GPCD, the backup supply requirement would have unmanageable at 12,000 gallons in 2009 and marginally manageable at 8,000 gallons in 2008 and 2011.

With the 35,000-gallon cistern, backup supply requirements would still have been unmanageable at 50 GPCD in 2008 and 2009, at 14,000 gallons in each year, and marginally manageable at 10,000 gallons in 2011. At 45 GPCD, the 2009 backup supply requirement would have been marginally manageable at 10,000 gallons.

With the 40,000-gallon cistern, at a usage rate of 50 GPCD, the 2009 backup supply requirement would have been unmanageable at 16,000 gallons, and the 2008 requirement would have been marginally manageable at 8,000 gallons. At a usage rate of 45 GPCD, the 2009 backup supply requirement would have been marginally manageable at 10,000 gallons. Even this largest configuration would require some degree of demand control during the most critical drought periods covered by the modeling to ensure a manageable tanker truck backup supply system.

High Usage Scenarios, Interior Usage Only

Two scenarios were run presuming 4-person occupancy with an average usage rate of 60 GPCD to evaluate the impact of more liberal water use. The first scenario presumes 5,500 ft² of roofprint and a cistern capacity of 45,000 gallons. The backup supply requirements would have been unmanageable in 2008 and 2009, at 12,000 gallons and 18,000 gallons, respectively. Under the curtailment scenario – usage rate would be reduced to 42 GPCD whenever the cistern level dropped below 7,200 gallons – backup supply requirements would have been manageable in all years. The other scenario presumes a roofprint of 6,000 ft² and a cistern capacity of 50,000 gallons. Backup supply would have been unmanageable in 2009 only, at 12,000 gallons. Under the curtailment scenario, backup supply would have been manageable in all years. This system would be right-sized for a 60 GPCD average usage rate with only minimal demand control through extreme drought periods.

Requirements to Cover Irrigation Usage

This section reviews the impacts on backup supply requirements of adding on irrigation usage to the scenarios reviewed above for interior usage only; an upsized system to provide the irrigation usage while maintaining backup supply requirements within a manageable level; and the impacts on backup supply requirements of employing wastewater reuse to defray irrigation usage. Note that for the curtailment scenarios, besides curtailing interior usage as reviewed previously, irrigation usage would be stopped completely whenever the cistern volume were to drop below the alarm level. For details of all these scenarios, see the modeling summaries for San Marcos in Appendix H Table A-8.

Irrigation WITHOUT Wastewater Reuse

With 2-person occupancy, to support 1,200 ft² of irrigated landscaping from the rainwater supply, the configuration with 2,500 ft² of roofprint would have required backup supply in

10-18 years, depending on the interior usage rate. The peak year requirements occurred in 2008 and ran from 18,000 gallons with an interior usage rate of 40 GPCD to 26,000 gallons with an interior usage rate of 50 GPCD. Under the curtailment scenario, backup supply would have been required in 15 years, and the maximum backup supply requirement would have been 16,000 gallons in 2008.

With 3,000 ft² of roofprint, backup supply would have been required in 6-12 years, depending on the interior usage rate. The peak was 2008 and/or 2011, and the requirements ranged from 14,000 gallons with an interior usage rate of 40 GPCD to 22,000 gallons with an interior usage rate of 50 GPCD. Under the curtailment scenario, backup supply would have been required in 12 years, and the maximum backup supply requirement would have been 12,000 gallons in 2008.

For the 2.5-person occupancy scenario, with 1,500 ft² of irrigated area supplied from the rainwater supply, backup supply would have been required in 6-10 years, depending on interior usage rate. The peak year was 2008 and/or 2011, and the quantity ran from 16,000 gallons with an interior usage rate of 40 GPCD to 28,000 gallons with an interior usage rate of 50 GPCD. Under the curtailment scenario, the peak backup supply requirement would have been 14,000 gallons in 2008 and in 2011. Some backup supply would have been required in 9 out of the 25 years in the model.

For 3-person occupancy, to supply 1,800 ft² of irrigated area from the rainwater supply, with a 20,000-gallon cistern, backup supply would have been required in 11-18 years, depending on interior usage rate. The 2011 requirement would have ranged from 26,000 gallons with an interior usage rate of 40 GPCD to 38,000 gallons with an interior usage rate of 50 GPCD. Under the curtailment scenario, the highest amount of backup supply would have been 12,000 gallons, in 2008 and in 2011, and backup supply would have been required in 16 years.

With a 25,000-gallon cistern, backup supply would have been required in 6-11 years, depending on the interior usage rate. The 2011 requirement would have ranged from 20,000 gallons with an interior usage rate of 40 GPCD to 36,000 gallons with a usage rate of 50 GPCD. Under the curtailment scenario, the highest amount of backup supply would have been 12,000 gallons in 2008, and some backup supply would have been required in 10 years.

Under the 4-person occupancy scenarios, to supply 2,400 ft² of irrigated area from the rainwater supply, backup supply would have been required in 7-19 years, depending on interior usage rate and system size. Without curtailment, the 2011 backup supply requirement ranged from 30,000 gallons for the largest system with an interior usage rate of 40 GPCD to 58,000 gallons for the smallest system with an interior usage rate of 50 GPCD. Under the curtailment scenarios, the peak-year backup supply requirements were 16,000 to 22,000 gallons, all occurring in 2008. Backup supply would have been required in 15, 12, and 12 years for the three configurations modeled, from the smallest to the largest, respectively.

One scenario, for 4-person occupancy, was modeled to show how much RWH facilities would have to be upsized in order to hold backup supply requirements to a manageable level if all irrigation usage were to be provided from the rainwater supply. This scenario presumes a roofprint of 7,000 ft² and a cistern capacity of 55,000 gallons. This is an increase of 2,500 ft² of roofprint and at least 15,000 gallons of cistern capacity above the 4-person occupancy scenarios previously reviewed. If the interior water usage rate were 50 GPCD, the backup supply requirement would have been an unmanageable 20,000 gallons in 2009, and manageable in all other years. At an interior usage rate of 45 GPCD, 8,000 gallons would have been required in 2009, considered to be a marginally manageable situation. At an interior usage rate of 40 GPCD, no backup supply would have been required in any year. If only irrigation had been curtailed when cistern volume dropped below the 6,000-gallon alarm level, at an interior usage rate of 50 GPCD, the backup supply requirements would have been a marginally manageable 10,000 gallons in 2009. At a usage rate of 45 GPCD, only 4,000 gallons would have been required in 2009, and at 40 GPCD no backup supply would have been required in any year. This configuration could be considered right-sized to provide for irrigation supply with only minimal curtailment of demand in the most extreme conditions observed over the modeling period.

Irrigation WITH Wastewater Reuse

If wastewater reuse *were* practiced to defray irrigation demands, the increase of backup supply requirements above those required with no irrigation usage would have been zero or 2,000 gallons in all years across all the occupancy presumptions, except for the following cases. For 2008, there was a 4,000-gallon increase in one case. For 2009, there was an 8,000-gallon increase in one case, and a 4,000-gallon increase in 10 cases. For 2011, there was a 6,000-gallon increase in one case, and a 4,000-gallon increase in 4 cases. For all of the curtailment scenarios, zero or 2,000 gallons of increase would have been incurred in any year.

Comparing these amounts to those that would have been required if wastewater reuse were *not* practiced graphically illustrates the high value to rainwater harvesters of such practice, if they wish to maintain any significant area of irrigated landscaping. As reviewed previously, even these small increases in backup supply could be avoided by choosing a native landscaping scheme that could survive on only the reclaimed water irrigation, or by curtailing irrigation through the more severe periods of drought, as illustrated by the results of the curtailment scenarios.

Wimberley

Around Wimberley, the backup supply peaking problem in 2011 was less severe than at some of the other modeling locations, so that less upsizing of RWH facilities and/or a lesser extent of demand control would be required to provide a right-sized configuration. The modeling summaries for Wimberley are displayed in Appendix I Table A-9.

2-Person Occupancy, Interior Usage Only

Two model runs for 2-person occupancy were executed. One presumes a roofprint of 2,500, and the other presumes a roofprint of 3,000 ft², each in combination with a 15,000-gallon cistern. The 2,500 ft² roofprint would incur manageable backup supply requirements in all years for all conditions modeled except in 2011 at a usage rate of 50

GPCD and under the curtailment scenario. In each of those cases, the backup supply requirement would have been 10,000 gallons, considered to be marginally manageable. With a roofprint of 3,000 ft², this RWH system would be right-sized for all usage rates modeled in all years.

2.5-Person Occupancy, Interior Usage Only

One scenario was run for a 2.5-person average occupancy, presuming a 3,500 ft² roofprint and a 20,000-gallon cistern. An average usage rate of 50 GPCD would have required 8,000 gallons of backup supply in 2011, considered to be marginally manageable. At all other usage rates, and under the curtailment scenario, this configuration would be right-sized for use this occupancy around Wimberley.

3-Person Occupancy, Interior Usage Only

Two scenarios were modeled for 3-person occupancy, both with a roofprint of 4,000 ft². In one scenario the cistern capacity is 20,000 gallons. At a usage rate of 50 GPCD, an unmanageable backup supply requirement of 14,000 gallons would have been incurred in 2011. At 45 GPCD and under the curtailment scenario, a marginally manageable 2011 backup supply requirement of 8,000 gallons would have been incurred. For the scenario with a 25,000-gallon cistern, the 2011 backup supply requirement of 8,000 gallons would also be considered marginally manageable. All other conditions modeled would have been manageable, so either of these configurations would be considered right-sized around Wimberley, given the appropriate level of demand control through the critical drought periods.

4-Person Occupancy, Interior Usage Only

Three scenarios were modeled presuming 4-person occupancy. In two scenarios, the roofprint is 4,500 ft², combined with cistern capacities of 30,000 and 35,000 gallons. With the 30,000-gallon cistern, at a usage rate of 50 GPCD, an unmanageable level of backup supply would have been incurred in 2009 and in 2011, at 16,000 gallons and 18,000 gallons, respectively. At a usage rate of 45 GPCD, marginally manageable backup supply requirements would have been incurred in both 2009 and 2011, at 10,000 gallons and 12,000 gallons, respectively. Under the curtailment scenario, a marginally manageable backup supply requirement of 10,000 gallons would have also been incurred in 2011. This configuration could be considered right-sized around Wimberley with the appropriate level of demand control through the critical drought periods.

With the 35,000-gallon cistern, a usage rate of 50 GPCD would still have incurred an unmanageable level of backup supply requirement in both 2009 and 2011, at 16,000 gallons and 14,000 gallons, respectively. Under all other conditions modeled, this configuration would be right-sized for Wimberley, requiring a bit lesser degree of demand control through the critical drought periods than the 30,000-gallon cistern configuration.

The third scenario presumes 5,000 ft² of roofprint and a cistern capacity of 40,000 gallons. This configuration would be considered right-sized for Wimberley, incurring a manageable backup supply requirement, under all conditions modeled, so would be the unrestricted configuration for this occupancy around Wimberley.

High Usage Scenarios, Interior Usage Only

Two scenarios were run presuming 4-person occupancy with an average usage rate of 60 GPCD to evaluate the impact of more liberal water use. The first scenario presumes 5,500 ft² of roofprint and a cistern capacity of 40,000 gallons. The backup supply requirements would have been unmanageable in 2009 and 2011, at 18,000 gallons in each year. Under the curtailment scenario – usage rate would be reduced to 42 GPCD whenever the cistern level dropped below 7,200 gallons – backup supply requirements would have been manageable in all years. The other scenario presumes a roofprint of 6,000 ft² and a cistern capacity of 50,000 gallons. Backup supply requirements would have been manageable even without curtailing demand during critical drought conditions. In fact, the modeling results show no change in backup supply requirements under the curtailment scenario. This system would be right-sized for a 60 GPCD average usage rate with no additional demand control even through the extreme drought periods within the modeling period.

Requirements to Cover Irrigation Usage

Issues reviewed in this section include the impacts on backup supply requirements of adding on irrigation usage to the scenarios reviewed above for interior usage only; an upsized system to provide the irrigation usage while maintaining backup supply requirements within a manageable level; and the impacts on backup supply requirements of employing wastewater reuse to defray irrigation usage. Note that for the curtailment scenarios, besides curtailing interior usage as reviewed previously, irrigation usage would be stopped completely whenever the cistern volume were to drop below the alarm level. For details of all these scenarios, see the modeling summaries for Wimberley in Appendix I Table A-9.

Irrigation WITHOUT Wastewater Reuse

With 2-person occupancy, to support 1,200 ft² of irrigated landscaping from the rainwater supply, the configuration with 2,500 ft² of roofprint would have required backup supply in 8-16 years, depending on the interior usage rate. The 2011 requirement ran from 20,000 gallons with an interior usage rate of 40 GPCD to 28,000 gallons with an interior usage rate of 50 GPCD. Under the curtailment scenario, backup supply would have been required in 15 years, and the maximum backup supply requirement would have been 14,000 gallons in 2011. With 3,000 ft² of roofprint, backup supply would have been required in 7 or 8 years, depending on the interior usage rate. The 2011 requirements ranged from 18,000 gallons with an interior usage rate of 40 GPCD to 24,000 gallons with an interior usage rate of 50 GPCD. Under the curtailment scenario, backup supply would have been required in 8 years, and the maximum backup supply requirement would have been 12,000 gallons in 2011.

For the 2.5-person occupancy scenario, with 1,500 ft² of irrigated area supplied from the rainwater supply, backup supply would have been required in 6-9 years, depending on interior usage rate. The quantity runs from 22,000 gallons with an interior usage rate of 40 GPCD to 30,000 gallons with an interior usage rate of 50 GPCD. Under the curtailment scenario, the peak backup supply requirement would have been 10,000 gallons in 2009 and in 2011. Some backup supply would have been required in 8 out of the 25 years in the model.

For 3-person occupancy, to supply 1,800 ft² of irrigated area from the rainwater supply, with the 20,000-gallon cistern, backup supply would have been required in 7-14 years, depending on interior usage rate. The 2011 requirement would have ranged from 30,000 gallons with an interior usage rate of 40 GPCD to 42,000 gallons with an interior usage rate of 50 GPCD. Under the curtailment scenario, the highest amount of backup supply would have been 12,000 gallons 2011, and backup supply would have been required in 13 years. With the 25,000-gallon cistern, backup supply would have been required in 6-9 years, depending on the interior usage rate. The 2011 requirement would have ranged from 26,000 gallons with an interior usage rate of 40 GPCD to 36,000 gallons with a usage rate of 50 GPCD. Under the curtailment scenario, the highest amount of backup supply would have been 10,000 gallons in 2009 and in 2011, and some backup supply would have been required in 7 years.

Under the 4-person occupancy scenarios, to supply 2,400 ft² of irrigated area from the rainwater supply, backup supply would have been required in 4-15 years, depending on interior usage rate and system size. Without curtailment, the 2011 backup supply requirement ranged from 30,000 gallons for the largest system with an interior usage rate of 40 GPCD to 58,000 gallons for the smallest system with an interior usage rate of 50 GPCD. Under the curtailment scenarios, the peak-year backup supply requirements would have been 14,000 in 1999 and in 2011 for the smallest configuration, 14,000 gallons in 2009 for the next largest configuration, and 14,000 gallons in 2011 for the largest configuration. Backup supply would have been required in 14, 11, and 7 years for the three configurations that were modeled, from the smallest to the largest, respectively.

One scenario, for 4-person occupancy, was modeled to show how much RWH facilities would have to be upsized in order to hold backup supply requirements to a manageable level if all irrigation usage were to be provided from the rainwater supply. This scenario presumed a roofprint of 7,000 ft² and a cistern capacity of 50,000 gallons. This is an increase of 2,500 ft² of roofprint and at least 10,000 gallons of cistern capacity above the 4-person occupancy scenarios previously reviewed. If the interior water usage rate were 50 GPCD, the backup supply requirements would have been 8,000 gallons in 2009, considered to be marginally manageable, and 22,000 gallons in 2011, an unmanageable situation. At an interior usage rate of 45 GPCD, 16,000 gallons would have been required in 2011 only, also an unmanageable situation. At an interior usage rate of 40 GPCD, 8,000 gallons of backup supply would have been required in 2011, a marginally manageable situation. If *only* irrigation had been curtailed whenever cistern volume dropped below the 6,000-gallon alarm level, at an interior usage rate of 50 GPCD, the backup supply requirements would have remained a marginally manageable 8,000 gallons in 2009, and dropped to an also marginally unmanageable 10,000 gallons in 2011. At a usage rate of 45 GPCD or less, a manageable level of backup supply would have been required in 2011. This configuration could be considered right-sized to provide for irrigation supply around Wimberley with sufficient curtailment of demand in the most extreme conditions observed over the modeling period.

Irrigation WITH Wastewater Reuse

If wastewater reuse *were* practiced to defray irrigation demands, the increase of backup supply requirements above those required with no irrigation usage would have been zero or

2,000 gallons in all years except 2011 across all the occupancy presumptions, except for 8 cases in 2009. In one of those cases, the increase was 8,000 gallons, in one case it was 6,000 gallons, and it was 4,000 gallons in the other 6 cases. For 2011, this increase would have been 8,000 gallons in one case, 6,000 gallons in one case, 4,000 gallons in 11 cases, 2,000 gallons in 9 cases, and no increase in one case. For all of the curtailment scenarios, zero or 2,000 gallons of increase would have been incurred in any year, except for one case where the increase was 4,000 gallons, occurring in 2009.

Comparing these amounts to those that would have been required if wastewater reuse were *not* practiced graphically illustrates the high value to rainwater harvesters of such practice, if they wish to maintain any significant area of irrigated landscaping. As reviewed previously, even these small increases in backup supply could be avoided by choosing a native landscaping scheme that could survive on only the reclaimed water irrigation, or by curtailing irrigation through the more severe periods of drought, as illustrated by the results of the curtailment scenarios.

Appendix B – Austin Rainwater Harvesting Modeling Summary

Austin Rainwater Harvesting Model Summary Interior Use Only				Austin Rainwater Harvesting Model Summary Interior Use & Irrigation				Austin Rainwater Harvesting Model Summary Interior Use & Irrigation with Wastewater Reuse			
House with 2 person occupancy				House with 2 person occupancy, 1200 sq. ft. irrigated area				House with 2 person occupancy, 1200 sq. ft. irrigated area			
System Size & Water Use		Backup Water Required		System Size & Water Use		Backup Water Required		System Size & Water Use		Backup Water Required	
Roofprint:	2,500 sq. ft.	Year	Amount (gallons)	% of total usage	Roofprint:	2,500 sq. ft.	Year	Amount (gallons)	% of total usage	Roofprint:	2,500 sq. ft.
Cistern size:	15,000 gallons	1994	2,000	5	Cistern size:	15,000 gallons	2008	4,000	11	Cistern size:	15,000 gallons
Occupancy:	2 persons	2009	4,000	11	Occupancy:	2 persons	2011	12,000	33	Occupancy:	2 persons
Usage rate:	50 gpcd	2011	12,000	33	Usage rate:	50 gpcd	Total:	22,000		Usage rate:	50 gpcd
Daily use:	100 gpd	Total:	22,000		Daily use:	100 gpd	Backup water required in 17 years		Daily use:	100 gpd	
System Size & Water Use		Backup Water Required		System Size & Water Use		Backup Water Required		System Size & Water Use		Backup Water Required	
Roofprint:	2,500 sq. ft.	Year	Amount (gallons)	% of total usage	Roofprint:	2,500 sq. ft.	Year	Amount (gallons)	% of total usage	Roofprint:	2,500 sq. ft.
Cistern size:	15,000 gallons	2009	2,000	6	Cistern size:	15,000 gallons	2011	10,000	30	Cistern size:	15,000 gallons
Occupancy:	2 persons	2011	10,000	30	Occupancy:	2 persons	Total:	12,000		Occupancy:	2 persons
Usage rate:	45 gpcd	2011	12,000	33	Usage rate:	45 gpcd	Backup water required in 15 years		Usage rate:	45 gpcd	
Daily use:	90 gpd	Total:	12,000		Daily use:	90 gpd	Max yr. =	28,000 in	2011	Daily use:	90 gpd
System Size & Water Use		Backup Water Required		System Size & Water Use		Backup Water Required		System Size & Water Use		Backup Water Required	
Roofprint:	2,500 sq. ft.	Year	Amount (gallons)	% of total usage	Roofprint:	2,500 sq. ft.	Year	Amount (gallons)	% of total usage	Roofprint:	2,500 sq. ft.
Cistern size:	15,000 gallons	2011	6,000	21	Cistern size:	15,000 gallons	2009	2,000	7	Cistern size:	15,000 gallons
Occupancy:	2 persons	Total:	6,000		Occupancy:	2 persons	2011	10,000	30	Occupancy:	2 persons
Usage rate:	40 gpcd	Backup water required in 14 years		Usage rate:	40 gpcd	Max yr. =	26,000 in	2011	Usage rate:	40 gpcd	
Daily use:	80 gpd	2nd most =	14,000 in	2008	Daily use:	80 gpd	Total req. =	78,000	gallons	Daily use:	80 gpd
System Size & Water Use		Backup Water Required		System Size & Water Use		Backup Water Required		System Size & Water Use		Backup Water Required	
Roofprint:	2,500 sq. ft.	Year	Amount (gallons)	% of total usage	Roofprint:	2,500 sq. ft.	Year	Amount (gallons)	% of total usage	Roofprint:	2,500 sq. ft.
Cistern size:	15,000 gallons	1994	2,000	6	Cistern size:	15,000 gallons	2009	2,000	6	Cistern size:	15,000 gallons
Curtailment vol:	3,000 gallons	2008	2,000	6	Curtailment vol:	3,000 gallons	2011	10,000	30	Curtailment vol:	3,000 gallons
Curtailment rate:	0.7 + irr.	2009	2,000	6	Curtailment rate:	0.7 + irr.	Total:	12,000		Curtailment rate:	0.7 + irr.
Occupancy:	2 persons	2011	8,000	26	Occupancy:	2 persons	Backup water required in 17 years		Occupancy:	2 persons	
Usage rate:	50 gpcd	Total:	14,000		Usage rate:	50 gpcd	Max yr. =	14,000 in	2 years	Usage rate:	50 gpcd
Daily use:	100 gpd	Backup water required in 17 years		Daily use:	100 gpd	2nd most =	6,000 in	1989	Daily use:	100 gpd	
System Size & Water Use		Backup Water Required		System Size & Water Use		Backup Water Required		System Size & Water Use		Backup Water Required	
Roofprint:	2,500 sq. ft.	Year	Amount (gallons)	% of total usage	Roofprint:	2,500 sq. ft.	Year	Amount (gallons)	% of total usage	Roofprint:	2,500 sq. ft.
Cistern size:	15,000 gallons	1994	2,000	6	Cistern size:	15,000 gallons	2009	2,000	6	Cistern size:	15,000 gallons
Curtailment vol:	3,000 gallons	2008	2,000	6	Curtailment vol:	3,000 gallons	2011	10,000	30	Curtailment vol:	3,000 gallons
Curtailment rate:	0.7 + irr.	2009	2,000	6	Curtailment rate:	0.7 + irr.	Total:	12,000		Curtailment rate:	0.7 + irr.
Occupancy:	2 persons	2011	8,000	26	Occupancy:	2 persons	Backup water required in 17 years		Occupancy:	2 persons	
Usage rate:	50 gpcd	Total:	14,000		Usage rate:	50 gpcd	Max yr. =	14,000 in	2 years	Usage rate:	50 gpcd
Daily use:	100 gpd	Backup water required in 17 years		Daily use:	100 gpd	2nd most =	6,000 in	1989	Daily use:	100 gpd	

Austin Rainwater Harvesting Model Summary Interior Use Only				Austin Rainwater Harvesting Model Summary Interior Use & Irrigation				Austin Rainwater Harvesting Model Summary Interior Use & Irrigation with Wastewater Reuse			
House with 2.5 person occupancy				House with 2.5 person occupancy, 1500 sq. ft. irrigated area				House with 2.5 person occupancy, 1500 sq. ft. irrigated area			
System Size & Water Use		Backup Water Required		System Size & Water Use		Backup Water Required		System Size & Water Use		Backup Water Required	
Roofprint:	3,500 sq. ft.	Year	Amount (gallons)	% of total usage	Roofprint:	3,500 sq. ft.	Year	Amount (gallons)	% of total usage	Roofprint:	3,500 sq. ft.
Cistern size:	20,000 gallons	2009	2,000	4	Cistern size:	20,000 gallons	2011	16,000	33	Cistern size:	20,000 gallons
Occupancy:	2.5 persons	2011	12,000	26	Occupancy:	2.5 persons	Total:	18,000		Occupancy:	2.5 persons
Usage rate:	50 gpcd	Total:	14,000		Usage rate:	50 gpcd	Backup water required in 15 years		Usage rate:	50 gpcd	
Daily use:	125 gpd	Backup water required in 15 years		Daily use:	125 gpd	Max yr. =	36,000 in	2009	Daily use:	125 gpd	
System Size & Water Use		Backup Water Required		System Size & Water Use		Backup Water Required		System Size & Water Use		Backup Water Required	
Roofprint:	3,500 sq. ft.	Year	Amount (gallons)	% of total usage	Roofprint:	3,500 sq. ft.	Year	Amount (gallons)	% of total usage	Roofprint:	3,500 sq. ft.
Cistern size:	20,000 gallons	2011	8,000	19	Cistern size:	20,000 gallons	2011	12,000	26	Cistern size:	20,000 gallons
Occupancy:	2.5 persons	Total:	8,000		Occupancy:	2.5 persons	Total:	12,000		Occupancy:	2.5 persons
Usage rate:	45 gpcd	Backup water required in 12 years		Usage rate:	45 gpcd	Max yr. =	32,000 in	2011	Usage rate:	45 gpcd	
Daily use:	112.5 gpd	2nd most =	16,000 in	2008	Daily use:	112.5 gpd	Total req. =	82,000	gallons	Daily use:	112.5 gpd
System Size & Water Use		Backup Water Required		System Size & Water Use		Backup Water Required		System Size & Water Use		Backup Water Required	
Roofprint:	3,500 sq. ft.	Year	Amount (gallons)	% of total usage	Roofprint:	3,500 sq. ft.	Year	Amount (gallons)	% of total usage	Roofprint:	3,500 sq. ft.
Cistern size:	20,000 gallons	2011	2,000	5	Cistern size:	20,000 gallons	2011	8,000	19	Cistern size:	20,000 gallons
Occupancy:	2.5 persons	Total:	2,000		Occupancy:	2.5 persons	Total:	8,000		Occupancy:	2.5 persons
Usage rate:	40 gpcd	Backup water required in 6 years		Usage rate:	40 gpcd	Max yr. =	28,000 in	2011	Usage rate:	40 gpcd	
Daily use:	100 gpd	2nd most =	10,000 in	2008	Daily use:	100 gpd	Total req. =	52,000	gallons	Daily use:	100 gpd
System Size & Water Use		Backup Water Required		System Size & Water Use		Backup Water Required		System Size & Water Use		Backup Water Required	
Roofprint:	3,500 sq. ft.	Year	Amount (gallons)	% of total usage	Roofprint:	3,500 sq. ft.	Year	Amount (gallons)	% of total usage	Roofprint:	3,500 sq. ft.
Cistern size:	20,000 gallons	2011	8,000	20	Cistern size:	20,000 gallons	2011	8,000	20	Cistern size:	20,000 gallons
Curtailment vol:	3,750 gallons	Total:	8,000		Curtailment vol:	3,750 gallons	Total:	8,000		Curtailment vol:	3,750 gallons
Curtailment rate:	0.7 + irr.	Backup water required in 12 years		Curtailment rate:	0.7 + irr.	Max yr. =	10,000 in	2011	Curtailment rate:	0.7 + irr.	
Occupancy:	2.5 persons	2nd most =	6,000 in	2 years	Occupancy:	2.5 persons	Total req. =	44,000	gallons	Occupancy:	2.5 persons
Usage rate:	50 gpcd	Backup water required in 12 years		Usage rate:	50 gpcd	Max yr. =	10,000 in	2011	Usage rate:	50 gpcd	
Daily use:	125 gpd	2nd most =	6,000 in	2 years	Daily use:	125 gpd	Total req. =	44,000	gallons	Daily use:	125 gpd

Austin Rainwater Harvesting Model Summary Interior Use Only					Austin Rainwater Harvesting Model Summary Interior Use & Irrigation					Austin Rainwater Harvesting Model Summary Interior Use & Irrigation with Wastewater Reuse				
House with 3 person occupancy					House with 3 person occupancy, 1800 sq. ft. irrigated area					House with 3 person occupancy, 1800 sq. ft. irrigated area				
System Size & Water Use					System Size & Water Use					System Size & Water Use				
Roofprint:	4,000	sq. ft.			Roofprint:	4,000	sq. ft.			Roofprint:	4,000	sq. ft.		
Cistern size:	25,000	gallons			Cistern size:	25,000	gallons			Cistern size:	25,000	gallons		
Occupancy:	3	persons			Occupancy:	3	persons			Occupancy:	3	persons		
Usage rate:	50	gpcd			Usage rate:	50	gpcd			Usage rate:	50	gpcd		
Daily use:	150	gpd			Daily use:	150	gpd			Daily use:	150	gpd		
Backup Water Required					Backup Water Required					Backup Water Required				
Year	Amount (gallons)	% of total usage			Year	Amount (gallons)	% of total usage			Year	Amount (gallons)	% of total usage		
2009	2,000	4			2009	2,000	4			2009	4,000	7		
2011	14,000	26			2011	14,000	26			2011	18,000	31		
Total:	16,000				Total:	16,000				Total:	22,000			
System Size & Water Use					System Size & Water Use					System Size & Water Use				
Roofprint:	4,000	sq. ft.			Roofprint:	4,000	sq. ft.			Roofprint:	4,000	sq. ft.		
Cistern size:	25,000	gallons			Cistern size:	25,000	gallons			Cistern size:	25,000	gallons		
Occupancy:	3	persons			Occupancy:	3	persons			Occupancy:	3	persons		
Usage rate:	45	gpcd			Usage rate:	45	gpcd			Usage rate:	45	gpcd		
Daily use:	135	gpd			Daily use:	135	gpd			Daily use:	135	gpd		
Backup Water Required					Backup Water Required					Backup Water Required				
Year	Amount (gallons)	% of total usage			Year	Amount (gallons)	% of total usage			Year	Amount (gallons)	% of total usage		
2011	8,000	16			2011	8,000	16			2011	14,000	26		
Total:	8,000				Total:	8,000				Total:	14,000			
System Size & Water Use					System Size & Water Use					System Size & Water Use				
Roofprint:	4,000	sq. ft.			Roofprint:	4,000	sq. ft.			Roofprint:	4,000	sq. ft.		
Cistern size:	25,000	gallons			Cistern size:	25,000	gallons			Cistern size:	25,000	gallons		
Occupancy:	3	persons			Occupancy:	3	persons			Occupancy:	3	persons		
Usage rate:	40	gpcd			Usage rate:	40	gpcd			Usage rate:	40	gpcd		
Daily use:	120	gpd			Daily use:	120	gpd			Daily use:	120	gpd		
Backup Water Required					Backup Water Required					Backup Water Required				
Year	Amount (gallons)	% of total usage			Year	Amount (gallons)	% of total usage			Year	Amount (gallons)	% of total usage		
2011	2,000	5			2011	2,000	5			2011	10,000	20		
Total:	2,000				Total:	2,000				Total:	10,000			
System Size & Water Use					System Size & Water Use					System Size & Water Use				
Roofprint:	4,000	sq. ft.			Roofprint:	4,000	sq. ft.			Roofprint:	4,000	sq. ft.		
Cistern size:	25,000	gallons			Cistern size:	25,000	gallons			Cistern size:	25,000	gallons		
Curtailment vol:	4,500	+ irr.			Curtailment vol:	4,500	+ irr.			Curtailment vol:	4,500	+ irr.		
Occupancy:	0.7	persons			Occupancy:	0.7	persons			Occupancy:	0.7	persons		
Usage rate:	50	gpcd			Usage rate:	50	gpcd			Usage rate:	50	gpcd		
Daily use:	150	gpd			Daily use:	150	gpd			Daily use:	150	gpd		
Backup Water Required					Backup Water Required					Backup Water Required				
Year	Amount (gallons)	% of total usage			Year	Amount (gallons)	% of total usage			Year	Amount (gallons)	% of total usage		
2009	2,000	4			2009	2,000	4			2009	2,000	4		
2011	8,000	17			2011	8,000	17			2011	10,000	20		
Total:	10,000				Total:	10,000				Total:	12,000			

Austin Rainwater Harvesting Model Summary Interior Use Only					Austin Rainwater Harvesting Model Summary Interior Use & Irrigation					Austin Rainwater Harvesting Model Summary Interior Use & Irrigation with Wastewater Reuse				
House with 4 person occupancy					House with 4 person occupancy, 2400 sq. ft. irrigated area					House with 4 person occupancy, 2400 sq. ft. irrigated area				
System Size & Water Use					System Size & Water Use					System Size & Water Use				
Roofprint:	4,500	sq. ft.			Roofprint:	4,500	sq. ft.			Roofprint:	4,500	sq. ft.		
Cistern size:	35,000	gallons			Cistern size:	35,000	gallons			Cistern size:	35,000	gallons		
Occupancy:	4	persons			Occupancy:	4	persons			Occupancy:	4	persons		
Usage rate:	50	gpcd			Usage rate:	50	gpcd			Usage rate:	50	gpcd		
Daily use:	200	gpd			Daily use:	200	gpd			Daily use:	200	gpd		
Backup Water Required					Backup Water Required					Backup Water Required				
Year	Amount (gallons)	% of total usage			Year	Amount (gallons)	% of total usage			Year	Amount (gallons)	% of total usage		
1990	2,000	3			1990	2,000	3			1989	2,000	3		
1994	2,000	3			1994	2,000	3			1990	2,000	3		
2008	4,000	5			2008	4,000	5			1994	4,000	5		
2009	8,000	11			2009	8,000	11			2008	6,000	8		
2011	22,000	30			2011	22,000	30			2009	10,000	13		
Total:	38,000				Total:	326,000				2011	26,000	33		
System Size & Water Use					System Size & Water Use					System Size & Water Use				
Roofprint:	4,500	sq. ft.			Roofprint:	4,500	sq. ft.			Roofprint:	4,500	sq. ft.		
Cistern size:	35,000	gallons			Cistern size:	35,000	gallons			Cistern size:	35,000	gallons		
Occupancy:	4	persons			Occupancy:	4	persons			Occupancy:	4	persons		
Usage rate:	45	gpcd			Usage rate:	45	gpcd			Usage rate:	45	gpcd		
Daily use:	180	gpd			Daily use:	180	gpd			Daily use:	180	gpd		
Backup Water Required					Backup Water Required					Backup Water Required				
Year	Amount (gallons)	% of total usage			Year	Amount (gallons)	% of total usage			Year	Amount (gallons)	% of total usage		
2009	2,000	3			2009	2,000	3			2009	4,000	6		
2011	12,000	18			2011	12,000	18			2011	20,000	27		
Total:	14,000				Total:	228,000				Total:	24,000			
System Size & Water Use					System Size & Water Use					System Size & Water Use				
Roofprint:	4,500	sq. ft.			Roofprint:	4,500	sq. ft.			Roofprint:	4,500	sq. ft.		
Cistern size:	35,000	gallons			Cistern size:	35,000	gallons			Cistern size:	35,000	gallons		
Occupancy:	4	persons			Occupancy:	4	persons			Occupancy:	4	persons		
Usage rate:	40	gpcd			Usage rate:	40	gpcd			Usage rate:	40	gpcd		
Daily use:	160	gpd			Daily use:	160	gpd			Daily use:	160	gpd		
Backup Water Required					Backup Water Required					Backup Water Required				
Year	Amount (gallons)	% of total usage			Year	Amount (gallons)	% of total usage			Year	Amount (gallons)	% of total usage		
2011	6,000	10			2011	6,000	10			2011	14,000	21		
Total:	6,000				Total:	144,000				Total:	14,000			
System Size & Water Use					System Size & Water Use					System Size & Water Use				
Roofprint:	4,500	sq. ft.			Roofprint:	4,500	sq. ft.			Roofprint:	4,500	sq. ft.		
Cistern size:	35,000	gallons			Cistern size:	35,000	gallons			Cistern size:	35,000	gallons		
Curtailment vol:	6,000	+ irr.			Curtailment vol:	6,000	+ irr.			Curtailment vol:	6,000	+ irr.		
Occupancy:	0.7	persons			Occupancy:	0.7	persons			Occupancy:	0.7	persons		
Usage rate:	50	gpcd			Usage rate:	50	gpcd			Usage rate:	50	gpcd		
Daily use:	200	gpd			Daily use:	200	gpd			Daily use:	200	gpd		
Backup Water Required					Backup Water Required					Backup Water Required				
Year	Amount (gallons)	% of total usage			Year	Amount (gallons)	% of total usage			Year	Amount (gallons)	% of total usage		
1990	2,000	3			1990	2,000	3			1990	2,000	3		
1994	2,000	4			1994	2,000	4			1994	2,000	4		
2008	4,000	6			2008	4,000	6			2008	4,000	6		
2009	2,000	3			2009	2,000	3			2009	2,000	3		
2011	14,000	23			2011	14,000	23			2011	16,000	25		
Total:	24,000				Total:	24,000				Total:	26,000			

Austin Rainwater Harvesting Model Summary
Interior Use Only

House with 4 person occupancy			
System Size & Water Use			
Year	Amount (gallons)	% of total usage	
Roofprint:	4,500 sq. ft.		
Cistern size:	40,000 gallons	1994	2,000 3
		2009	6,000 8
Occupancy:	4 persons	2011	16,000 22
Usage rate:	50 gpcd	Total:	24,000
Daily use:	200 gpd		
Backup Water Required			
Year	Amount (gallons)	% of total usage	
Roofprint:	4,500 sq. ft.		
Cistern size:	40,000 gallons	2011	8,000 12
Occupancy:	4 persons	Total:	8,000
Usage rate:	45 gpcd		
Daily use:	180 gpd		
Backup Water Required			
Year	Amount (gallons)	% of total usage	
Roofprint:	4,500 sq. ft.		
Cistern size:	40,000 gallons	NONE required	
Occupancy:	4 persons		
Usage rate:	40 gpcd		
Daily use:	160 gpd		
Backup Water Required			
Year	Amount (gallons)	% of total usage	
Roofprint:	4,500 sq. ft.		
Cistern size:	40,000 gallons	2009	4,000 6
Curtailment vol:	6,000 gallons	2011	10,000 16
Curtailment rate:	0.7 + irr.	Total:	14,000
Occupancy:	4 persons		
Usage rate:	50 gpcd		
Daily use:	200 gpd		

Austin Rainwater Harvesting Model Summary
Interior Use & Irrigation

House with 4 person occupancy, 2400 sq. ft. irrigated area			
System Size & Water Use			
Year	Amount (gallons)	% of total usage	
Roofprint:	4,500 sq. ft.		
Cistern size:	40,000 gallons	Backup water required in 15 years	
		Max yr. =	60,000 in 2011
Occupancy:	4 persons	2nd most =	40,000 in 2008
Usage rate:	50 gpcd	Total req. =	282,000 gallons
Daily use:	200 gpd		
Backup Water Required			
Year	Amount (gallons)	% of total usage	
Roofprint:	4,500 sq. ft.		
Cistern size:	40,000 gallons	Backup water required in 13 years	
		Max yr. =	48,000 in 2011
Occupancy:	4 persons	2nd most =	30,000 in 2008
Usage rate:	45 gpcd	Total req. =	19,000 gallons
Daily use:	180 gpd		
Backup Water Required			
Year	Amount (gallons)	% of total usage	
Roofprint:	4,500 sq. ft.		
Cistern size:	40,000 gallons	Backup water required in 8 years	
		Max yr. =	42,000 in 2011
Occupancy:	4 persons	2nd most =	18,000 in 2008
Usage rate:	40 gpcd	Total req. =	96,000 gallons
Daily use:	160 gpd		
Backup Water Required			
Year	Amount (gallons)	% of total usage	
Roofprint:	4,500 sq. ft.		
Cistern size:	40,000 gallons	Backup water required in 15 years	
		Max yr. =	16,000 in 2011
Curtailment vol:	6,000 gallons	2nd most =	10,000 in 4 years
Curtailment rate:	0.7 + irr.	Total req. =	94,000 gallons
Occupancy:	4 persons		
Usage rate:	50 gpcd		
Daily use:	200 gpd		

Austin Rainwater Harvesting Model Summary
Interior Use & Irrigation with Wastewater Reuse

House with 4 person occupancy, 2400 sq. ft. irrigated area			
System Size & Water Use			
Year	Amount (gallons)	% of total usage	
Roofprint:	4,500 sq. ft.		
Cistern size:	40,000 gallons	1994	2,000 3
		2008	2,000 3
Occupancy:	4 persons	2009	8,000 11
Usage rate:	50 gpcd	2011	22,000 28
Daily use:	200 gpd	Total:	34,000
Backup Water Required			
Year	Amount (gallons)	% of total usage	
Roofprint:	4,500 sq. ft.		
Cistern size:	40,000 gallons	2011	14,000 19
Occupancy:	4 persons	Total:	14,000
Usage rate:	45 gpcd		
Daily use:	180 gpd		
Backup Water Required			
Year	Amount (gallons)	% of total usage	
Roofprint:	4,500 sq. ft.		
Cistern size:	40,000 gallons	2011	10,000 15
Occupancy:	4 persons	Total:	10,000
Usage rate:	40 gpcd		
Daily use:	160 gpd		
Backup Water Required			
Year	Amount (gallons)	% of total usage	
Roofprint:	4,500 sq. ft.		
Cistern size:	40,000 gallons	1994	2,000 3
Curtailment vol:	6,000 gallons	2008	2,000 3
Curtailment rate:	0.7 + irr.	2009	4,000 6
Occupancy:	4 persons	2011	10,000 16
Usage rate:	50 gpcd	Total:	18,000
Daily use:	200 gpd		

Austin Rainwater Harvesting Model Summary
Interior Use Only

House with 4 person occupancy			
System Size & Water Use			
Year	Amount (gallons)	% of total usage	
Roofprint:	5,000 sq. ft.		
Cistern size:	40,000 gallons	2009	2,000 3
		2011	12,000 16
Occupancy:	4 persons	Total:	14,000
Usage rate:	50 gpcd		
Daily use:	200 gpd		
Backup Water Required			
Year	Amount (gallons)	% of total usage	
Roofprint:	5,000 sq. ft.		
Cistern size:	40,000 gallons	2011	6,000 9
Occupancy:	4 persons	Total:	6,000
Usage rate:	45 gpcd		
Daily use:	180 gpd		
Backup Water Required			
Year	Amount (gallons)	% of total usage	
Roofprint:	5,000 sq. ft.		
Cistern size:	40,000 gallons	NONE required	
Occupancy:	4 persons		
Usage rate:	40 gpcd		
Daily use:	160 gpd		
Backup Water Required			
Year	Amount (gallons)	% of total usage	
Roofprint:	5,000 sq. ft.		
Cistern size:	40,000 gallons	2011	8,000 13
Curtailment vol:	6,000 gallons	Total:	8,000
Curtailment rate:	0.7 + irr.		
Occupancy:	4 persons		
Usage rate:	50 gpcd		
Daily use:	200 gpd		

Austin Rainwater Harvesting Model Summary
Interior Use & Irrigation

House with 4 person occupancy, 2400 sq. ft. irrigated area			
System Size & Water Use			
Year	Amount (gallons)	% of total usage	
Roofprint:	5,000 sq. ft.		
Cistern size:	40,000 gallons	Backup water required in 13 years	
		Max yr. =	54,000 in 2011
Occupancy:	4 persons	2nd most =	34,000 in 2008
Usage rate:	50 gpcd	Total req. =	206,000 gallons
Daily use:	200 gpd		
Backup Water Required			
Year	Amount (gallons)	% of total usage	
Roofprint:	5,000 sq. ft.		
Cistern size:	40,000 gallons	Backup water required in 9 years	
		Max yr. =	44,000 in 2011
Occupancy:	4 persons	2nd most =	24,000 in 2008
Usage rate:	45 gpcd	Total req. =	130,000 gallons
Daily use:	180 gpd		
Backup Water Required			
Year	Amount (gallons)	% of total usage	
Roofprint:	5,000 sq. ft.		
Cistern size:	40,000 gallons	Backup water required in 6 years	
		Max yr. =	38,000 in 2011
Occupancy:	4 persons	2nd most =	12,000 in 2008
Usage rate:	40 gpcd	Total req. =	74,000 gallons
Daily use:	160 gpd		
Backup Water Required			
Year	Amount (gallons)	% of total usage	
Roofprint:	5,000 sq. ft.		
Cistern size:	40,000 gallons	Backup water required in 11 years	
		Max yr. =	20,000 in 2011
Curtailment vol:	6,000 gallons	2nd most =	12,000 in 2008
Curtailment rate:	0.7 + irr.	Total req. =	70,000 gallons
Occupancy:	4 persons		
Usage rate:	50 gpcd		
Daily use:	200 gpd		

Austin Rainwater Harvesting Model Summary
Interior Use & Irrigation with Wastewater Reuse

House with 4 person occupancy, 2400 sq. ft. irrigated area			
System Size & Water Use			
Year	Amount (gallons)	% of total usage	
Roofprint:	5,000 sq. ft.		
Cistern size:	40,000 gallons	2009	4,000 5
		2011	18,000 23
Occupancy:	4 persons	Total:	22,000
Usage rate:	50 gpcd		
Daily use:	200 gpd		
Backup Water Required			
Year	Amount (gallons)	% of total usage	
Roofprint:	5,000 sq. ft.		
Cistern size:	40,000 gallons	2011	12,000 16
Occupancy:	4 persons	Total:	12,000
Usage rate:	45 gpcd		
Daily use:	180 gpd		
Backup Water Required			
Year	Amount (gallons)	% of total usage	
Roofprint:	5,000 sq. ft.		
Cistern size:	40,000 gallons	2011	6,000 9
Occupancy:	4 persons	Total:	6,000
Usage rate:	40 gpcd		
Daily use:	160 gpd		
Backup Water Required			
Year	Amount (gallons)	% of total usage	
Roofprint:	5,000 sq. ft.		
Cistern size:	40,000 gallons	2009	2,000 3
Curtailment vol:	6,000 gallons	2011	10,000 15
Curtailment rate:	0.7 + irr.	Total:	12,000
Occupancy:	4 persons		
Usage rate:	50 gpcd		
Daily use:	200 gpd		

Austin Rainwater Harvesting Model Summary Interior Use Only				Austin Rainwater Harvesting Model Summary Interior Use & Irrigation				Austin Rainwater Harvesting Model Summary Interior Use & Irrigation with Wastewater Reuse			
House with 4 person occupancy				House with 4 person occupancy, 2400 sq. ft. irrigated area				House with 4 person occupancy, 2400 sq. ft. irrigated area			
System Size & Water Use				System Size & Water Use				System Size & Water Use			
Roofprint:	5,500	sq. ft.		Roofprint:	5,500	sq. ft.		Roofprint:	5,500	sq. ft.	
Cistern size:	50,000	gallons		Cistern size:	50,000	gallons		Cistern size:	50,000	gallons	
Occupancy:	4	persons		Occupancy:	4	persons		Occupancy:	4	persons	
Usage rate:	60	gpcd		Usage rate:	60	gpcd		Usage rate:	60	gpcd	
Daily use:	240	gpd		Daily use:	240	gpd		Daily use:	240	gpd	
Backup Water Required				Backup Water Required				Backup Water Required			
Year	Amount (gallons)	% of total usage		Year	Amount (gallons)	% of total usage		Year	Amount (gallons)	% of total usage	
2009	4,000	5		Backup water required in 10 years				2009	4,000	5	
2011	16,000	18		Max yr. =	56,000	in	2011	2011	18,000	20	
Total:	20,000			2nd most =	38,000	in	2008	Total:	22,000		
System Size & Water Use				System Size & Water Use				System Size & Water Use			
Roofprint:	5,500	sq. ft.		Roofprint:	5,500	sq. ft.		Roofprint:	5,500	sq. ft.	
Cistern size:	50,000	gallons		Cistern size:	50,000	gallons		Cistern size:	50,000	gallons	
Curtaiment vol:	7,200	gallons		Curtaiment vol:	7,200	gallons		Curtaiment vol:	7,200	gallons	
Curtaiment rate:	0.7	+ irr.		Curtaiment rate:	0.7	+ irr.		Curtaiment rate:	0.7	+ irr.	
Occupancy:	4	persons		Occupancy:	4	persons		Occupancy:	4	persons	
Usage rate:	60	gpcd		Usage rate:	60	gpcd		Usage rate:	60	gpcd	
Daily use:	240	gpd		Daily use:	240	gpd		Daily use:	240	gpd	
Backup Water Required				Backup Water Required				Backup Water Required			
Year	Amount (gallons)	% of total usage		Year	Amount (gallons)	% of total usage		Year	Amount (gallons)	% of total usage	
2009	4,000	5		Backup water required in 9 years				2009	2,000	3	
2011	12,000	16		Max yr. =	18,000	in	2011	2011	10,000	13	
Total:	16,000			2nd most =	12,000	in	2008	Total:	12,000		
System Size & Water Use				System Size & Water Use				System Size & Water Use			
Roofprint:	6,000	sq. ft.		Roofprint:	6,000	sq. ft.		Roofprint:	6,000	sq. ft.	
Cistern size:	55,000	gallons		Cistern size:	55,000	gallons		Cistern size:	55,000	gallons	
Occupancy:	4	persons		Occupancy:	4	persons		Occupancy:	4	persons	
Usage rate:	60	gpcd		Usage rate:	60	gpcd		Usage rate:	60	gpcd	
Daily use:	240	gpd		Daily use:	240	gpd		Daily use:	240	gpd	
Backup Water Required				Backup Water Required				Backup Water Required			
Year	Amount (gallons)	% of total usage		Year	Amount (gallons)	% of total usage		Year	Amount (gallons)	% of total usage	
2011	8,000	9		Backup water required in 7 years				2011	10,000	11	
Total:	8,000			Max yr. =	48,000	in	2011	Total:	10,000		
System Size & Water Use				System Size & Water Use				System Size & Water Use			
Roofprint:	6,000	sq. ft.		Roofprint:	6,000	sq. ft.		Roofprint:	6,000	sq. ft.	
Cistern size:	55,000	gallons		Cistern size:	55,000	gallons		Cistern size:	55,000	gallons	
Curtaiment vol:	7,200	gallons		Curtaiment vol:	7,200	gallons		Curtaiment vol:	7,200	gallons	
Curtaiment rate:	0.7	+ irr.		Curtaiment rate:	0.7	+ irr.		Curtaiment rate:	0.7	+ irr.	
Occupancy:	4	persons		Occupancy:	4	persons		Occupancy:	4	persons	
Usage rate:	60	gpcd		Usage rate:	60	gpcd		Usage rate:	60	gpcd	
Daily use:	240	gpd		Daily use:	240	gpd		Daily use:	240	gpd	
Backup Water Required				Backup Water Required				Backup Water Required			
Year	Amount (gallons)	% of total usage		Year	Amount (gallons)	% of total usage		Year	Amount (gallons)	% of total usage	
2011	4,000	5		Backup water required in 7 years				2011	6,000	7	
Total:	4,000			Max yr. =	18,000	in	2011	Total:	6,000		
System Size & Water Use				System Size & Water Use				System Size & Water Use			
Roofprint:	6,000	sq. ft.		Roofprint:	6,000	sq. ft.		Roofprint:	6,000	sq. ft.	
Cistern size:	55,000	gallons		Cistern size:	55,000	gallons		Cistern size:	55,000	gallons	
Curtaiment vol:	7,200	gallons		Curtaiment vol:	7,200	gallons		Curtaiment vol:	7,200	gallons	
Curtaiment rate:	0.7	+ irr.		Curtaiment rate:	0.7	+ irr.		Curtaiment rate:	0.7	+ irr.	
Occupancy:	4	persons		Occupancy:	4	persons		Occupancy:	4	persons	
Usage rate:	60	gpcd		Usage rate:	60	gpcd		Usage rate:	60	gpcd	
Daily use:	240	gpd		Daily use:	240	gpd		Daily use:	240	gpd	

Requirements for house with 4 person occupancy, 2,400 sq. ft. irrigated area with no wastewater irrigation											
System Size & Water Use				System Size & Water Use				System Size & Water Use			
Roofprint:	7,500	sq. ft.		Roofprint:	7,500	sq. ft.		Roofprint:	7,500	sq. ft.	
Cistern size:	55,000	gallons		Cistern size:	55,000	gallons		Cistern size:	55,000	gallons	
Occupancy:	4	persons		Occupancy:	4	persons		Occupancy:	4	persons	
Usage rate:	50	gpcd		Usage rate:	45	gpcd		Usage rate:	40	gpcd	
Daily use:	200	gpd		Daily use:	180	gpd		Daily use:	160	gpd	
Backup Water Required				Backup Water Required				Backup Water Required			
Year	Amount (gallons)	% of total usage		Year	Amount (gallons)	% of total usage		Year	Amount (gallons)	% of total usage	
2011	24,000	22		2011	16,000	16		2011	8,000	8	
Total:	24,000			Total:	16,000			Total:	8,000		
System Size & Water Use				System Size & Water Use				System Size & Water Use			
Roofprint:	7,500	sq. ft.		Roofprint:	7,500	sq. ft.		Roofprint:	7,500	sq. ft.	
Cistern size:	55,000	gallons		Cistern size:	55,000	gallons		Cistern size:	55,000	gallons	
Curtaiment vol:	6,000	gallons		Curtaiment vol:	6,000	gallons		Curtaiment vol:	6,000	gallons	
Curtaiment rate:	1.0	irr. only		Curtaiment rate:	1.0	irr. only		Curtaiment rate:	1.0	irr. only	
Occupancy:	4	persons		Occupancy:	4	persons		Occupancy:	4	persons	
Usage rate:	50	gpcd		Usage rate:	45	gpcd		Usage rate:	40	gpcd	
Daily use:	200	gpd		Daily use:	180	gpd		Daily use:	160	gpd	
Backup Water Required				Backup Water Required				Backup Water Required			
Year	Amount (gallons)	% of total usage		Year	Amount (gallons)	% of total usage		Year	Amount (gallons)	% of total usage	
2011	6,000	7		2011	8,000	9		2011	2,000	2	
Total:	6,000			Total:	8,000			Total:	2,000		

Appendix C – Blanco Rainwater Harvesting Modeling Summary

Blanco Rainwater Harvesting Model Summary Interior Use Only				Blanco Rainwater Harvesting Model Summary Interior Use & Irrigation				Blanco Rainwater Harvesting Model Summary Interior Use & Irrigation with Wastewater Reuse			
House with 2 person occupancy				House with 2 person occupancy, 1200 sq. ft. irrigated area				House with 2 person occupancy, 1200 sq. ft. irrigated area			
System Size & Water Use		Backup Water Required		System Size & Water Use		Backup Water Required		System Size & Water Use		Backup Water Required	
Roofprint:	2,500 sq. ft.	Year	Amount (gallons)	% of total usage	Roofprint:	2,500 sq. ft.	Year	Amount (gallons)	% of total usage	Roofprint:	2,500 sq. ft.
Cistern size:	15,000 gallons	1999	4,000	11	Cistern size:	15,000 gallons	2000	2,000	5	Cistern size:	15,000 gallons
Occupancy:	2 persons	2006	4,000	11	Occupancy:	2 persons	2006	6,000	16	Occupancy:	2 persons
Usage rate:	50 gpcd	2008	6,000	16	Usage rate:	50 gpcd	2008	8,000	21	Usage rate:	50 gpcd
Daily use:	100 gpd	2009	8,000	22	Daily use:	100 gpd	2009	6,000	16	Daily use:	100 gpd
		2011	12,000	33			2011	14,000	36		
		Total:	36,000				Total:	40,000			
System Size & Water Use		Backup Water Required		System Size & Water Use		Backup Water Required		System Size & Water Use		Backup Water Required	
Roofprint:	2,500 sq. ft.	Year	Amount (gallons)	% of total usage	Roofprint:	2,500 sq. ft.	Year	Amount (gallons)	% of total usage	Roofprint:	2,500 sq. ft.
Cistern size:	15,000 gallons	2008	4,000	12	Cistern size:	15,000 gallons	2009	4,000	12	Cistern size:	15,000 gallons
Occupancy:	2 persons	2009	4,000	12	Occupancy:	2 persons	2011	8,000	24	Occupancy:	2 persons
Usage rate:	45 gpcd	2011	8,000	24	Usage rate:	45 gpcd	Total:	16,000		Usage rate:	45 gpcd
Daily use:	90 gpd				Daily use:	90 gpd				Daily use:	90 gpd
System Size & Water Use		Backup Water Required		System Size & Water Use		Backup Water Required		System Size & Water Use		Backup Water Required	
Roofprint:	2,500 sq. ft.	Year	Amount (gallons)	% of total usage	Roofprint:	2,500 sq. ft.	Year	Amount (gallons)	% of total usage	Roofprint:	2,500 sq. ft.
Cistern size:	15,000 gallons	2009	2,000	7	Cistern size:	15,000 gallons	2009	2,000	7	Cistern size:	15,000 gallons
Occupancy:	2 persons	2011	4,000	14	Occupancy:	2 persons	2011	6,000	14	Occupancy:	2 persons
Usage rate:	40 gpcd	Total:	6,000		Usage rate:	40 gpcd	Total:	6,000		Usage rate:	40 gpcd
Daily use:	80 gpd				Daily use:	80 gpd				Daily use:	80 gpd
System Size & Water Use		Backup Water Required		System Size & Water Use		Backup Water Required		System Size & Water Use		Backup Water Required	
Roofprint:	2,500 sq. ft.	Year	Amount (gallons)	% of total usage	Roofprint:	2,500 sq. ft.	Year	Amount (gallons)	% of total usage	Roofprint:	2,500 sq. ft.
Cistern size:	15,000 gallons	1999	4,000	11	Cistern size:	15,000 gallons	2009	2,000	7	Cistern size:	15,000 gallons
Curtailment vol:	3,000 gallons	2006	4,000	11	Curtailment vol:	3,000 gallons	2011	4,000	13	Curtailment vol:	3,000 gallons
Curtailment rate:	0.7 + irr.	2008	6,000	17	Curtailment rate:	0.7 + irr.	2008	6,000	17	Curtailment rate:	0.7 + irr.
Occupancy:	2 persons	2009	6,000	17	Occupancy:	2 persons	2009	6,000	17	Occupancy:	2 persons
Usage rate:	50 gpcd	2011	10,000	29	Usage rate:	50 gpcd	2011	10,000	29	Usage rate:	50 gpcd
Daily use:	100 gpd	Total:	26,000		Daily use:	100 gpd	Total:	26,000		Daily use:	100 gpd
System Size & Water Use		Backup Water Required		System Size & Water Use		Backup Water Required		System Size & Water Use		Backup Water Required	
Roofprint:	3,000 sq. ft.	Year	Amount (gallons)	% of total usage	Roofprint:	3,000 sq. ft.	Year	Amount (gallons)	% of total usage	Roofprint:	3,000 sq. ft.
Cistern size:	15,000 gallons	2008	2,000	5	Cistern size:	15,000 gallons	2006	2,000	5	Cistern size:	15,000 gallons
Occupancy:	2 persons	2009	4,000	11	Occupancy:	2 persons	2008	4,000	11	Occupancy:	2 persons
Usage rate:	50 gpcd	2011	6,000	17	Usage rate:	50 gpcd	2009	4,000	11	Usage rate:	50 gpcd
Daily use:	100 gpd	Total:	12,000		Daily use:	100 gpd	2011	8,000	22	Daily use:	100 gpd
System Size & Water Use		Backup Water Required		System Size & Water Use		Backup Water Required		System Size & Water Use		Backup Water Required	
Roofprint:	3,000 sq. ft.	Year	Amount (gallons)	% of total usage	Roofprint:	3,000 sq. ft.	Year	Amount (gallons)	% of total usage	Roofprint:	3,000 sq. ft.
Cistern size:	15,000 gallons	2009	2,000	6	Cistern size:	15,000 gallons	2009	2,000	6	Cistern size:	15,000 gallons
Occupancy:	2 persons	2011	4,000	12	Occupancy:	2 persons	2011	8,000	22	Occupancy:	2 persons
Usage rate:	45 gpcd	Total:	6,000		Usage rate:	45 gpcd	Total:	12,000		Usage rate:	45 gpcd
Daily use:	90 gpd				Daily use:	90 gpd				Daily use:	90 gpd
System Size & Water Use		Backup Water Required		System Size & Water Use		Backup Water Required		System Size & Water Use		Backup Water Required	
Roofprint:	3,000 sq. ft.	Year	Amount (gallons)	% of total usage	Roofprint:	3,000 sq. ft.	Year	Amount (gallons)	% of total usage	Roofprint:	3,000 sq. ft.
Cistern size:	15,000 gallons	NONE required			Cistern size:	15,000 gallons	2011	6,000	18	Cistern size:	15,000 gallons
Occupancy:	2 persons				Occupancy:	2 persons	Total:	6,000		Occupancy:	2 persons
Usage rate:	40 gpcd				Usage rate:	40 gpcd				Usage rate:	40 gpcd
Daily use:	80 gpd				Daily use:	80 gpd				Daily use:	80 gpd
System Size & Water Use		Backup Water Required		System Size & Water Use		Backup Water Required		System Size & Water Use		Backup Water Required	
Roofprint:	3,000 sq. ft.	Year	Amount (gallons)	% of total usage	Roofprint:	3,000 sq. ft.	Year	Amount (gallons)	% of total usage	Roofprint:	3,000 sq. ft.
Cistern size:	15,000 gallons	2008	2,000	6	Cistern size:	15,000 gallons	2006	2,000	5	Cistern size:	15,000 gallons
Curtailment vol:	3,000 gallons	2009	4,000	11	Curtailment vol:	3,000 gallons	2008	4,000	11	Curtailment vol:	3,000 gallons
Curtailment rate:	0.7 + irr.	2011	6,000	18	Curtailment rate:	0.7 + irr.	2009	2,000	6	Curtailment rate:	0.7 + irr.
Occupancy:	2 persons	Total:	12,000		Occupancy:	2 persons	2011	8,000	22	Occupancy:	2 persons
Usage rate:	50 gpcd				Usage rate:	50 gpcd	Total:	16,000		Usage rate:	50 gpcd
Daily use:	100 gpd				Daily use:	100 gpd				Daily use:	100 gpd

Blanco Rainwater Harvesting Model Summary
Interior Use Only

House with 2.5 person occupancy			
System Size & Water Use		Backup Water Required	
		Year	Amount (gallons)
Roofprint:	3,500 sq. ft.		
Cistern size:	20,000 gallons	2008	4,000
		2009	6,000
Occupancy:	2.5 persons	2011	10,000
Usage rate:	50 gpcd	Total:	20,000
Daily use:	125 gpd		
Backup Water Required			
System Size & Water Use		Backup Water Required	
		Year	Amount (gallons)
Roofprint:	3,500 sq. ft.		
Cistern size:	20,000 gallons	2009	2,000
		2011	4,000
Occupancy:	2.5 persons	Total:	6,000
Usage rate:	45 gpcd		
Daily use:	112.5 gpd		
Backup Water Required			
System Size & Water Use		Backup Water Required	
		Year	Amount (gallons)
Roofprint:	3,500 sq. ft.		
Cistern size:	20,000 gallons	NONE required	
Occupancy:	2.5 persons		
Usage rate:	40 gpcd		
Daily use:	100 gpd		
Backup Water Required			
System Size & Water Use		Backup Water Required	
		Year	Amount (gallons)
Roofprint:	3,500 sq. ft.		
Cistern size:	20,000 gallons	2008	2,000
Curtailment vol:	3,750 gallons	2009	4,000
Curtailment rate:	0.7 + irr.	2011	6,000
Occupancy:	2.5 persons	Total:	12,000
Usage rate:	50 gpcd		
Daily use:	125 gpd		

Blanco Rainwater Harvesting Model Summary
Interior Use & Irrigation

House with 2.5 person occupancy, 1500 sq. ft. irrigated area			
System Size & Water Use		Backup Water Required	
		Year	Amount (gallons)
Roofprint:	3,500 sq. ft.		
Cistern size:	20,000 gallons	Backup water required in 12 years	
		Max yr. =	34,000 in 2011
Occupancy:	2.5 persons	2nd most =	22,000 in 2008
Usage rate:	50 gpcd	Total req. =	148,000 gallons
Daily use:	125 gpd		
Backup Water Required			
System Size & Water Use		Backup Water Required	
		Year	Amount (gallons)
Roofprint:	3,500 sq. ft.		
Cistern size:	20,000 gallons	Backup water required in 10 years	
		Max yr. =	28,000 in 2011
Occupancy:	2.5 persons	2nd most =	16,000 in 3 years
Usage rate:	45 gpcd	Total req. =	106,000 gallons
Daily use:	112.5 gpd		
Backup Water Required			
System Size & Water Use		Backup Water Required	
		Year	Amount (gallons)
Roofprint:	3,500 sq. ft.		
Cistern size:	20,000 gallons	Backup water required in 7 years	
		Max yr. =	24,000 in 2011
Occupancy:	2.5 persons	2nd most =	14,000 in 2009
Usage rate:	40 gpcd	Total req. =	72,000 gallons
Daily use:	100 gpd		
Backup Water Required			
System Size & Water Use		Backup Water Required	
		Year	Amount (gallons)
Roofprint:	3,500 sq. ft.		
Cistern size:	20,000 gallons	Backup water required in 11 years	
		Max yr. =	12,000 in 2011
Curtailment vol:	3,750 gallons	2nd most =	8,000 in 3 years
Curtailment rate:	0.7 + irr.	Total req. =	64,000 gallons
Occupancy:	2.5 persons		
Usage rate:	50 gpcd		
Daily use:	125 gpd		

Blanco Rainwater Harvesting Model Summary
Interior Use & Irrigation with Wastewater Reuse

House with 2.5 person occupancy, 1500 sq. ft. irrigated area			
System Size & Water Use		Backup Water Required	
		Year	Amount (gallons)
Roofprint:	3,500 sq. ft.		
Cistern size:	20,000 gallons	2000	2,000
		2006	2,000
Occupancy:	2.5 persons	2008	4,000
Usage rate:	50 gpcd	2009	8,000
Daily use:	125 gpd	2011	12,000
		Total:	28,000
Backup Water Required			
System Size & Water Use		Backup Water Required	
		Year	Amount (gallons)
Roofprint:	3,500 sq. ft.		
Cistern size:	20,000 gallons	2009	4,000
		2011	8,000
Occupancy:	2.5 persons	Total:	12,000
Usage rate:	45 gpcd		
Daily use:	112.5 gpd		
Backup Water Required			
System Size & Water Use		Backup Water Required	
		Year	Amount (gallons)
Roofprint:	3,500 sq. ft.		
Cistern size:	20,000 gallons	2011	4,000
Occupancy:	2.5 persons	Total:	4,000
Usage rate:	40 gpcd		
Daily use:	100 gpd		
Backup Water Required			
System Size & Water Use		Backup Water Required	
		Year	Amount (gallons)
Roofprint:	3,500 sq. ft.		
Cistern size:	20,000 gallons	2006	2,000
Curtailment vol:	3,750 gallons	2008	2,000
Curtailment rate:	0.7 + irr.	2009	4,000
Occupancy:	2.5 persons	2011	6,000
Usage rate:	50 gpcd	Total:	14,000
Daily use:	125 gpd		

Blanco Rainwater Harvesting Model Summary
Interior Use Only

House with 3 person occupancy			
System Size & Water Use		Backup Water Required	
		Year	Amount (gallons)
Roofprint:	4,000 sq. ft.		
Cistern size:	20,000 gallons	1999	2,000
		2000	4,000
Occupancy:	3 persons	2006	4,000
Usage rate:	50 gpcd	2008	8,000
Daily use:	150 gpd	2009	10,000
		2011	16,000
		Total:	44,000
Backup Water Required			
System Size & Water Use		Backup Water Required	
		Year	Amount (gallons)
Roofprint:	4,000 sq. ft.		
Cistern size:	20,000 gallons	2008	2,000
		2009	6,000
Occupancy:	3 persons	2011	10,000
Usage rate:	45 gpcd	Total:	18,000
Daily use:	135 gpd		
Backup Water Required			
System Size & Water Use		Backup Water Required	
		Year	Amount (gallons)
Roofprint:	4,000 sq. ft.		
Cistern size:	20,000 gallons	2009	2,000
		2011	4,000
Occupancy:	3 persons	Total:	6,000
Usage rate:	40 gpcd		
Daily use:	120 gpd		
Backup Water Required			
System Size & Water Use		Backup Water Required	
		Year	Amount (gallons)
Roofprint:	4,000 sq. ft.		
Cistern size:	20,000 gallons	1999	2,000
Curtailment vol:	4,500 gallons	2006	4,000
Curtailment rate:	0.7 + irr.	2008	6,000
Occupancy:	3 persons	2009	4,000
Usage rate:	50 gpcd	2011	8,000
Daily use:	150 gpd	Total:	24,000

Blanco Rainwater Harvesting Model Summary
Interior Use & Irrigation

House with 3 person occupancy, 1800 sq. ft. irrigated area			
System Size & Water Use		Backup Water Required	
		Year	Amount (gallons)
Roofprint:	4,000 sq. ft.		
Cistern size:	20,000 gallons	Backup water required in 15 years	
		Max yr. =	44,000 in 2011
Occupancy:	3 persons	2nd most =	32,000 in 2008
Usage rate:	50 gpcd	Total req. =	220,000 gallons
Daily use:	150 gpd		
Backup Water Required			
System Size & Water Use		Backup Water Required	
		Year	Amount (gallons)
Roofprint:	4,000 sq. ft.		
Cistern size:	20,000 gallons	Backup water required in 15 years	
		Max yr. =	38,000 in 2011
Occupancy:	3 persons	2nd most =	26,000 in 2008
Usage rate:	45 gpcd	Total req. =	172,000 gallons
Daily use:	135 gpd		
Backup Water Required			
System Size & Water Use		Backup Water Required	
		Year	Amount (gallons)
Roofprint:	4,000 sq. ft.		
Cistern size:	20,000 gallons	Backup water required in 12 years	
		Max yr. =	44,000 in 2011
Occupancy:	3 persons	2nd most =	18,000 in 2 years
Usage rate:	40 gpcd	Total req. =	128,000 gallons
Daily use:	120 gpd		
Backup Water Required			
System Size & Water Use		Backup Water Required	
		Year	Amount (gallons)
Roofprint:	4,000 sq. ft.		
Cistern size:	20,000 gallons	Backup water required in 12 years	
		Max yr. =	14,000 in 1999
Curtailment vol:	4,500 gallons	2nd most =	10,000 in 4 years
Curtailment rate:	0.7 + irr.	Total req. =	82,000 gallons
Occupancy:	3 persons		
Usage rate:	50 gpcd		
Daily use:	150 gpd		

Blanco Rainwater Harvesting Model Summary
Interior Use & Irrigation with Wastewater Reuse

House with 3 person occupancy, 1800 sq. ft. irrigated area			
System Size & Water Use		Backup Water Required	
		Year	Amount (gallons)
Roofprint:	4,000 sq. ft.		
Cistern size:	20,000 gallons	1999	4,000
		2000	2,000
Occupancy:	3 persons	2006	8,000
Usage rate:	50 gpcd	2008	10,000
Daily use:	150 gpd	2009	8,000
		2011	20,000
		Total:	52,000
Backup Water Required			
System Size & Water Use		Backup Water Required	
		Year	Amount (gallons)
Roofprint:	4,000 sq. ft.		
Cistern size:	20,000 gallons	1999	2,000
		2006	2,000
Occupancy:	3 persons	2008	4,000
Usage rate:	45 gpcd	2009	8,000
Daily use:	135 gpd	2011	14,000
		Total:	30,000
Backup Water Required			
System Size & Water Use		Backup Water Required	
		Year	Amount (gallons)
Roofprint:	4,000 sq. ft.		
Cistern size:	20,000 gallons	2009	4,000
		2011	10,000
Occupancy:	3 persons	Total:	14,000
Usage rate:	40 gpcd		
Daily use:	120 gpd		
Backup Water Required			
System Size & Water Use		Backup Water Required	
		Year	Amount (gallons)
Roofprint:	4,000 sq. ft.		
Cistern size:	20,000 gallons	1999	4,000
Curtailment vol:	4,500 gallons	2006	4,000
Curtailment rate:	0.7 + irr.	2008	6,000
Occupancy:	3 persons	2009	6,000
Usage rate:	50 gpcd	2011	8,000
Daily use:	150 gpd	Total:	28,000

Blanco Rainwater Harvesting Model Summary
Interior Use Only

House with 3 person occupancy			
System Size & Water Use			
Roofprint:	4,000	sq. ft.	
Cistern size:	25,000	gallons	
Occupancy:	3	persons	
Usage rate:	50	gpcd	
Daily use:	150	gpd	
Backup Water Required			
Year	Amount (gallons)	% of total usage	
2008	4,000	7	
2009	8,000	15	
2011	12,000	22	
Total:	24,000		
System Size & Water Use			
Roofprint:	4,000	sq. ft.	
Cistern size:	25,000	gallons	
Occupancy:	3	persons	
Usage rate:	45	gpcd	
Daily use:	135	gpd	
Backup Water Required			
Year	Amount (gallons)	% of total usage	
2009	4,000	8	
2011	6,000	12	
Total:	10,000		
System Size & Water Use			
Roofprint:	4,000	sq. ft.	
Cistern size:	25,000	gallons	
Occupancy:	3	persons	
Usage rate:	40	gpcd	
Daily use:	120	gpd	
Backup Water Required			
Year	Amount (gallons)	% of total usage	
NONE required			
System Size & Water Use			
Roofprint:	4,000	sq. ft.	
Cistern size:	25,000	gallons	
Occupancy:	3	persons	
Usage rate:	50	gpcd	
Daily use:	150	gpd	
Backup Water Required			
Year	Amount (gallons)	% of total usage	
2008	2,000	4	
2009	4,000	8	
2011	6,000	13	
Total:	12,000		

Blanco Rainwater Harvesting Model Summary
Interior Use & Irrigation

House with 3 person occupancy, 1800 sq. ft. irrigated area			
System Size & Water Use			
Roofprint:	4,000	sq. ft.	
Cistern size:	25,000	gallons	
Occupancy:	3	persons	
Usage rate:	50	gpcd	
Daily use:	150	gpd	
Backup Water Required			
Year	Amount (gallons)	% of total usage	
2008	4,000	7	
2009	8,000	15	
2011	12,000	22	
Total:	24,000		
System Size & Water Use			
Roofprint:	4,000	sq. ft.	
Cistern size:	25,000	gallons	
Occupancy:	3	persons	
Usage rate:	45	gpcd	
Daily use:	135	gpd	
Backup Water Required			
Year	Amount (gallons)	% of total usage	
2009	4,000	8	
2011	6,000	12	
Total:	10,000		
System Size & Water Use			
Roofprint:	4,000	sq. ft.	
Cistern size:	25,000	gallons	
Occupancy:	3	persons	
Usage rate:	40	gpcd	
Daily use:	120	gpd	
Backup Water Required			
Year	Amount (gallons)	% of total usage	
NONE required			
System Size & Water Use			
Roofprint:	4,000	sq. ft.	
Cistern size:	25,000	gallons	
Occupancy:	3	persons	
Usage rate:	50	gpcd	
Daily use:	150	gpd	
Backup Water Required			
Year	Amount (gallons)	% of total usage	
2008	2,000	4	
2009	4,000	8	
2011	6,000	13	
Total:	12,000		

Blanco Rainwater Harvesting Model Summary
Interior Use & Irrigation with Wastewater Reuse

House with 3 person occupancy, 1800 sq. ft. irrigated area			
System Size & Water Use			
Roofprint:	4,000	sq. ft.	
Cistern size:	25,000	gallons	
Occupancy:	3	persons	
Usage rate:	50	gpcd	
Daily use:	150	gpd	
Backup Water Required			
Year	Amount (gallons)	% of total usage	
2000	2,000	4	
2006	2,000	4	
2008	4,000	7	
2009	10,000	18	
2011	14,000	24	
Total:	32,000		
System Size & Water Use			
Roofprint:	4,000	sq. ft.	
Cistern size:	25,000	gallons	
Occupancy:	3	persons	
Usage rate:	45	gpcd	
Daily use:	135	gpd	
Backup Water Required			
Year	Amount (gallons)	% of total usage	
2008	4,000	7	
2009	6,000	12	
2011	10,000	19	
Total:	20,000		
System Size & Water Use			
Roofprint:	4,000	sq. ft.	
Cistern size:	25,000	gallons	
Occupancy:	3	persons	
Usage rate:	40	gpcd	
Daily use:	120	gpd	
Backup Water Required			
Year	Amount (gallons)	% of total usage	
2011	6,000	12	
Total:	6,000		
System Size & Water Use			
Roofprint:	4,000	sq. ft.	
Cistern size:	25,000	gallons	
Occupancy:	3	persons	
Usage rate:	50	gpcd	
Daily use:	150	gpd	
Backup Water Required			
Year	Amount (gallons)	% of total usage	
2006	2,000	4	
2008	4,000	8	
2009	4,000	8	
2011	6,000	12	
Total:	16,000		

Blanco Rainwater Harvesting Model Summary
Interior Use Only

House with 4 person occupancy			
System Size & Water Use			
Roofprint:	4,500	sq. ft.	
Cistern size:	35,000	gallons	
Occupancy:	4	persons	
Usage rate:	50	gpcd	
Daily use:	200	gpd	
Backup Water Required			
Year	Amount (gallons)	% of total usage	
1999	2,000	3	
2000	6,000	8	
2006	10,000	14	
2008	10,000	14	
2009	16,000	22	
2011	18,000	25	
Total:	62,000		
System Size & Water Use			
Roofprint:	4,500	sq. ft.	
Cistern size:	35,000	gallons	
Occupancy:	4	persons	
Usage rate:	45	gpcd	
Daily use:	180	gpd	
Backup Water Required			
Year	Amount (gallons)	% of total usage	
2008	2,000	3	
2009	10,000	15	
2011	10,000	15	
Total:	22,000		
System Size & Water Use			
Roofprint:	4,500	sq. ft.	
Cistern size:	35,000	gallons	
Occupancy:	4	persons	
Usage rate:	40	gpcd	
Daily use:	160	gpd	
Backup Water Required			
Year	Amount (gallons)	% of total usage	
2009	2,000	3	
2011	2,000	3	
Total:	4,000		
System Size & Water Use			
Roofprint:	4,500	sq. ft.	
Cistern size:	35,000	gallons	
Occupancy:	4	persons	
Usage rate:	50	gpcd	
Daily use:	200	gpd	
Backup Water Required			
Year	Amount (gallons)	% of total usage	
1990	2,000	3	
1994	2,000	3	
2008	4,000	6	
2009	6,000	10	
2011	10,000	16	
Total:	24,000		

Blanco Rainwater Harvesting Model Summary
Interior Use & Irrigation

House with 4 person occupancy, 2400 sq. ft. irrigated area			
System Size & Water Use			
Roofprint:	4,500	sq. ft.	
Cistern size:	35,000	gallons	
Occupancy:	4	persons	
Usage rate:	50	gpcd	
Daily use:	200	gpd	
Backup Water Required			
Year	Amount (gallons)	% of total usage	
2008	4,000	7	
2009	8,000	15	
2011	12,000	22	
Total:	24,000		
System Size & Water Use			
Roofprint:	4,500	sq. ft.	
Cistern size:	35,000	gallons	
Occupancy:	4	persons	
Usage rate:	45	gpcd	
Daily use:	180	gpd	
Backup Water Required			
Year	Amount (gallons)	% of total usage	
2009	4,000	7	
2011	6,000	11	
Total:	10,000		
System Size & Water Use			
Roofprint:	4,500	sq. ft.	
Cistern size:	35,000	gallons	
Occupancy:	4	persons	
Usage rate:	40	gpcd	
Daily use:	160	gpd	
Backup Water Required			
Year	Amount (gallons)	% of total usage	
2008	4,000	7	
2009	8,000	13	
2011	10,000	15	
Total:	22,000		
System Size & Water Use			
Roofprint:	4,500	sq. ft.	
Cistern size:	35,000	gallons	
Occupancy:	4	persons	
Usage rate:	50	gpcd	
Daily use:	200	gpd	
Backup Water Required			
Year	Amount (gallons)	% of total usage	
1990	2,000	3	
1994	2,000	3	
2008	4,000	6	
2009	6,000	10	
2011	10,000	16	
Total:	24,000		

Blanco Rainwater Harvesting Model Summary
Interior Use & Irrigation with Wastewater Reuse

House with 4 person occupancy, 2400 sq. ft. irrigated area			
System Size & Water Use			
Roofprint:	4,500	sq. ft.	
Cistern size:	35,000	gallons	
Occupancy:	4	persons	
Usage rate:	50	gpcd	
Daily use:	200	gpd	
Backup Water Required			
Year	Amount (gallons)	% of total usage	
1999	4,000	5	
2000	8,000	11	
2006	14,000	19	
2008	12,000	16	
2009	18,000	24	
2011	22,000	28	
Total:	78,000		
System Size & Water Use			
Roofprint:	4,500	sq. ft.	
Cistern size:	35,000	gallons	
Occupancy:	4	persons	
Usage rate:	45	gpcd	
Daily use:	180	gpd	
Backup Water Required			
Year	Amount (gallons)	% of total usage	
2000	2,000	3	
2006	6,000	9	
2008	4,000	6	
2009	14,000	20	
2011	16,000	22	
Total:	42,000		
System Size & Water Use			
Roofprint:	4,500	sq. ft.	
Cistern size:	35,000	gallons	
Occupancy:	4	persons	
Usage rate:	40	gpcd	
Daily use:	160	gpd	
Backup Water Required			
Year	Amount (gallons)	% of total usage	
2009	8,000	13	
2011	10,000	15	
Total:	18,000		
System Size & Water Use			
Roofprint:	4,500	sq. ft.	
Cistern size:	35,000	gallons	
Occupancy:	4	persons	
Usage rate:	50	gpcd	
Daily use:	200	gpd	
Backup Water Required			
Year	Amount (gallons)	% of total usage	
1990	4,000	5	
1994	2,000	3	
2008	6,000	9	
2009	6,000	9	
2011	12,000	19	
Total:	30,000		

Blanco Rainwater Harvesting Model Summary
Interior Use Only

System Size & Water Use		Backup Water Required		
		Year	Amount (gallons)	% of total usage
House with 4 person occupancy				
Roofprint:	4,500 sq. ft.			
Cistern size:	40,000 gallons	2000	4,000	5
		2006	6,000	8
Occupancy:	4 persons	2008	6,000	8
Usage rate:	50 gpcd	2009	16,000	22
Daily use:	200 gpd	2011	12,000	16
		Total:	44,000	
System Size & Water Use		Backup Water Required		
		Year	Amount (gallons)	% of total usage
Roofprint:	4,500 sq. ft.			
Cistern size:	40,000 gallons	2009	8,000	12
		2011	4,000	6
Occupancy:	4 persons	Total:	12,000	
Usage rate:	45 gpcd			
Daily use:	180 gpd			
System Size & Water Use		Backup Water Required		
		Year	Amount (gallons)	% of total usage
Roofprint:	4,500 sq. ft.			
Cistern size:	40,000 gallons	NONE required		
Occupancy:	4 persons			
Usage rate:	40 gpcd			
Daily use:	160 gpd			
System Size & Water Use		Backup Water Required		
		Year	Amount (gallons)	% of total usage
Roofprint:	4,500 sq. ft.			
Cistern size:	40,000 gallons	2006	4,000	6
Curtailment vol:	6,000 gallons	2008	4,000	6
Curtailment rate:	0.7 + irr.	2009	8,000	13
Occupancy:	4 persons	2011	8,000	13
Usage rate:	50 gpcd	Total:	24,000	
Daily use:	200 gpd			

Blanco Rainwater Harvesting Model Summary
Interior Use & Irrigation

System Size & Water Use		Backup Water Required		
		Year	Amount (gallons)	% of total usage
House with 4 person occupancy, 2400 sq. ft. irrigated area				
Roofprint:	4,500 sq. ft.			
Cistern size:	40,000 gallons	Backup water required in 13 years		
		Max yr. =	52,000 in	2011
Occupancy:	4 persons	2nd most =	44,000 in	2006
Usage rate:	50 gpcd	Total req. =	322,000 gallons	
Daily use:	200 gpd			
System Size & Water Use		Backup Water Required		
		Year	Amount (gallons)	% of total usage
Roofprint:	4,500 sq. ft.			
Cistern size:	40,000 gallons	Backup water required in 11 years		
		Max yr. =	44,000 in	2011
Occupancy:	4 persons	2nd most =	36,000 in	2 years
Usage rate:	45 gpcd	Total req. =	222,000 gallons	
Daily use:	180 gpd			
System Size & Water Use		Backup Water Required		
		Year	Amount (gallons)	% of total usage
Roofprint:	4,500 sq. ft.			
Cistern size:	40,000 gallons	Backup water required in 8 years		
		Max yr. =	36,000 in	2011
Occupancy:	4 persons	2nd most =	30,000 in	2006
Usage rate:	40 gpcd	Total req. =	144,000 gallons	
Daily use:	160 gpd			
System Size & Water Use		Backup Water Required		
		Year	Amount (gallons)	% of total usage
Roofprint:	4,500 sq. ft.			
Cistern size:	40,000 gallons	Backup water required in 12 years		
		Max yr. =	16,000 in	2011
Curtailment rate:	0.7 + irr.	2nd most =	10,000 in	5 years
Occupancy:	4 persons	Total req. =	94,000 gallons	
Usage rate:	50 gpcd			
Daily use:	200 gpd			

Blanco Rainwater Harvesting Model Summary
Interior Use & Irrigation with Wastewater Reuse

System Size & Water Use		Backup Water Required		
		Year	Amount (gallons)	% of total usage
House with 4 person occupancy, 2400 sq. ft. irrigated area				
Roofprint:	4,500 sq. ft.			
Cistern size:	40,000 gallons	2000	6,000	8
		2006	10,000	13
Occupancy:	4 persons	2008	8,000	11
Usage rate:	50 gpcd	2009	18,000	24
Daily use:	200 gpd	2011	16,000	21
		Total:	58,000	
System Size & Water Use		Backup Water Required		
		Year	Amount (gallons)	% of total usage
Roofprint:	4,500 sq. ft.			
Cistern size:	40,000 gallons	2008	2,000	3
		2009	12,000	17
Occupancy:	4 persons	2011	10,000	14
Usage rate:	45 gpcd	Total:	24,000	
Daily use:	180 gpd			
System Size & Water Use		Backup Water Required		
		Year	Amount (gallons)	% of total usage
Roofprint:	4,500 sq. ft.			
Cistern size:	40,000 gallons	2009	4,000	6
		2011	4,000	6
Occupancy:	4 persons	Total:	8,000	
Usage rate:	40 gpcd			
Daily use:	160 gpd			
System Size & Water Use		Backup Water Required		
		Year	Amount (gallons)	% of total usage
Roofprint:	4,500 sq. ft.			
Cistern size:	40,000 gallons	2000	2,000	3
Curtailment vol:	6,000 gallons	2006	2,000	3
Curtailment rate:	0.7 + irr.	2008	4,000	6
Occupancy:	4 persons	2009	8,000	13
Usage rate:	50 gpcd	2011	10,000	15
Daily use:	200 gpd	Total:	26,000	

Blanco Rainwater Harvesting Model Summary
Interior Use Only

System Size & Water Use		Backup Water Required		
		Year	Amount (gallons)	% of total usage
House with 4 person occupancy				
Roofprint:	5,000 sq. ft.			
Cistern size:	40,000 gallons	2008	2,000	3
		2009	12,000	16
Occupancy:	4 persons	2011	8,000	11
Usage rate:	50 gpcd	Total:	22,000	
Daily use:	200 gpd			
System Size & Water Use		Backup Water Required		
		Year	Amount (gallons)	% of total usage
Roofprint:	5,000 sq. ft.			
Cistern size:	40,000 gallons	2009	2,000	3
		2011	2,000	3
Occupancy:	4 persons	Total:	4,000	
Usage rate:	45 gpcd			
Daily use:	180 gpd			
System Size & Water Use		Backup Water Required		
		Year	Amount (gallons)	% of total usage
Roofprint:	5,000 sq. ft.			
Cistern size:	40,000 gallons	NONE required		
Occupancy:	4 persons			
Usage rate:	40 gpcd			
Daily use:	160 gpd			
System Size & Water Use		Backup Water Required		
		Year	Amount (gallons)	% of total usage
Roofprint:	5,000 sq. ft.			
Cistern size:	40,000 gallons	2009	4,000	6
Curtailment vol:	6,000 gallons	2011	4,000	6
Curtailment rate:	0.7 + irr.	Total:	8,000	
Occupancy:	4 persons			
Usage rate:	50 gpcd			
Daily use:	200 gpd			

Blanco Rainwater Harvesting Model Summary
Interior Use & Irrigation

System Size & Water Use		Backup Water Required		
		Year	Amount (gallons)	% of total usage
House with 4 person occupancy, 2400 sq. ft. irrigated area				
Roofprint:	5,000 sq. ft.			
Cistern size:	40,000 gallons	Backup water required in 11 years		
		Max yr. =	48,000 in	2011
Occupancy:	4 persons	2nd most =	38,000 in	2006
Usage rate:	50 gpcd	Total req. =	232,000 gallons	
Daily use:	200 gpd			
System Size & Water Use		Backup Water Required		
		Year	Amount (gallons)	% of total usage
Roofprint:	5,000 sq. ft.			
Cistern size:	40,000 gallons	Backup water required in 8 years		
		Max yr. =	40,000 in	2011
Occupancy:	4 persons	2nd most =	32,000 in	2006
Usage rate:	45 gpcd	Total req. =	162,000 gallons	
Daily use:	180 gpd			
System Size & Water Use		Backup Water Required		
		Year	Amount (gallons)	% of total usage
Roofprint:	5,000 sq. ft.			
Cistern size:	40,000 gallons	Backup water required in 7 years		
		Max yr. =	32,000 in	2011
Occupancy:	4 persons	2nd most =	26,000 in	2009
Usage rate:	40 gpcd	Total req. =	110,000 gallons	
Daily use:	160 gpd			
System Size & Water Use		Backup Water Required		
		Year	Amount (gallons)	% of total usage
Roofprint:	5,000 sq. ft.			
Cistern size:	40,000 gallons	Backup water required in 11 years		
		Max yr. =	14,000 in	2 years
Curtailment vol:	6,000 gallons	2nd most =	12,000 in	
Curtailment rate:	0.7 + irr.	Total req. =	74,000 gallons	
Occupancy:	4 persons			
Usage rate:	50 gpcd			
Daily use:	200 gpd			

Blanco Rainwater Harvesting Model Summary
Interior Use & Irrigation with Wastewater Reuse

System Size & Water Use		Backup Water Required		
		Year	Amount (gallons)	% of total usage
House with 4 person occupancy, 2400 sq. ft. irrigated area				
Roofprint:	5,000 sq. ft.			
Cistern size:	40,000 gallons	2008	2,000	3
		2009	14,000	19
Occupancy:	4 persons	2011	14,000	18
Usage rate:	50 gpcd	Total:	30,000	
Daily use:	200 gpd			
System Size & Water Use		Backup Water Required		
		Year	Amount (gallons)	% of total usage
Roofprint:	5,000 sq. ft.			
Cistern size:	40,000 gallons	2009	6,000	9
		2011	8,000	11
Occupancy:	4 persons	Total:	14,000	
Usage rate:	45 gpcd			
Daily use:	180 gpd			
System Size & Water Use		Backup Water Required		
		Year	Amount (gallons)	% of total usage
Roofprint:	5,000 sq. ft.			
Cistern size:	40,000 gallons	2011	2,000	3
Occupancy:	4 persons	Total:	2,000	
Usage rate:	40 gpcd			
Daily use:	160 gpd			
System Size & Water Use		Backup Water Required		
		Year	Amount (gallons)	% of total usage
Roofprint:	5,000 sq. ft.			
Cistern size:	40,000 gallons	1994	2,000	3
Curtailment vol:	6,000 gallons	2009	6,000	9
Curtailment rate:	0.7 + irr.	2011	6,000	9
Occupancy:	4 persons	Total:	14,000	
Usage rate:	50 gpcd			
Daily use:	200 gpd			

Blanco Rainwater Harvesting Model Summary				Blanco Rainwater Harvesting Model Summary				Blanco Rainwater Harvesting Model Summary			
Interior Use Only				Interior Use & Irrigation				Interior Use & Irrigation with Wastewater Reuse			
House with 4 person occupancy				House with 4 person occupancy, 2400 sq. ft. irrigated area				House with 4 person occupancy, 2400 sq. ft. irrigated area			
System Size & Water Use				System Size & Water Use				System Size & Water Use			
Roofprint:	5,500	sq. ft.		Roofprint:	5,500	sq. ft.		Roofprint:	5,500	sq. ft.	
Cistern size:	50,000	gallons		Cistern size:	50,000	gallons		Cistern size:	50,000	gallons	
Occupancy:	4	persons		Occupancy:	4	persons		Occupancy:	4	persons	
Usage rate:	60	gpcd		Usage rate:	60	gpcd		Usage rate:	60	gpcd	
Daily use:	240	gpd		Daily use:	240	gpd		Daily use:	240	gpd	
Backup Water Required				Backup Water Required				Backup Water Required			
Year	Amount (gallons)	% of total usage		Year	Amount (gallons)	% of total usage		Year	Amount (gallons)	% of total usage	
2006	2,000	2		Backup water required in 11 years				2006	2,000	2	
2008	4,000	5		Max yr. =	52,000	in	2011	2008	4,000	5	
2009	18,000	21		2nd most =	46,000	in	2006	2009	18,000	21	
2011	12,000	14		Total req. =	282,000	gallons		2011	12,000	14	
Total:	36,000							Total:	36,000		
System Size & Water Use				System Size & Water Use				System Size & Water Use			
Roofprint:	5,500	sq. ft.		Roofprint:	5,500	sq. ft.		Roofprint:	5,500	sq. ft.	
Cistern size:	50,000	gallons		Cistern size:	50,000	gallons		Cistern size:	50,000	gallons	
Curtailment vol:	7,200	gallons		Curtailment vol:	7,200	gallons		Curtailment vol:	7,200	gallons	
Curtailment rate:	0.7	+ irr.		Curtailment rate:	0.7	+ irr.		Curtailment rate:	0.7	+ irr.	
Occupancy:	4	persons		Occupancy:	4	persons		Occupancy:	4	persons	
Usage rate:	60	gpcd		Usage rate:	60	gpcd		Usage rate:	60	gpcd	
Daily use:	240	gpd		Daily use:	240	gpd		Daily use:	240	gpd	
Backup Water Required				Backup Water Required				Backup Water Required			
Year	Amount (gallons)	% of total usage		Year	Amount (gallons)	% of total usage		Year	Amount (gallons)	% of total usage	
2008	2,000	2		Backup water required in 10 years				2008	2,000	2	
2009	6,000	8		Max yr. =	16,000	in	2006	2009	8,000	11	
2011	6,000	8		2nd most =	14,000	in	3 years	2011	6,000	8	
Total:	14,000			Total req. =	90,000	gallons		Total:	16,000		
System Size & Water Use				System Size & Water Use				System Size & Water Use			
Roofprint:	6,000	sq. ft.		Roofprint:	6,000	sq. ft.		Roofprint:	6,000	sq. ft.	
Cistern size:	55,000	gallons		Cistern size:	55,000	gallons		Cistern size:	55,000	gallons	
Occupancy:	4	persons		Occupancy:	4	persons		Occupancy:	4	persons	
Usage rate:	60	gpcd		Usage rate:	60	gpcd		Usage rate:	60	gpcd	
Daily use:	240	gpd		Daily use:	240	gpd		Daily use:	240	gpd	
Backup Water Required				Backup Water Required				Backup Water Required			
Year	Amount (gallons)	% of total usage		Year	Amount (gallons)	% of total usage		Year	Amount (gallons)	% of total usage	
2009	8,000	9		Backup water required in 8 years				2009	10,000	11	
2011	4,000	5		Max yr. =	42,000	in	2011	2011	4,000	5	
Total:	12,000			2nd most =	40,000	in	2006	Total:	14,000		
System Size & Water Use				System Size & Water Use				System Size & Water Use			
Roofprint:	6,000	sq. ft.		Roofprint:	6,000	sq. ft.		Roofprint:	6,000	sq. ft.	
Cistern size:	55,000	gallons		Cistern size:	55,000	gallons		Cistern size:	55,000	gallons	
Curtailment vol:	7,200	gallons		Curtailment vol:	7,200	gallons		Curtailment vol:	7,200	gallons	
Curtailment rate:	0.7	+ irr.		Curtailment rate:	0.7	+ irr.		Curtailment rate:	0.7	+ irr.	
Occupancy:	4	persons		Occupancy:	4	persons		Occupancy:	4	persons	
Usage rate:	60	gpcd		Usage rate:	60	gpcd		Usage rate:	60	gpcd	
Daily use:	240	gpd		Daily use:	240	gpd		Daily use:	240	gpd	
Backup Water Required				Backup Water Required				Backup Water Required			
Year	Amount (gallons)	% of total usage		Year	Amount (gallons)	% of total usage		Year	Amount (gallons)	% of total usage	
2009	2,000	8		Backup water required in 7 years				2009	2,000	3	
Total:	2,000			Max yr. =	14,000	in	2 years	2011	2,000	2	
System Size & Water Use				System Size & Water Use				System Size & Water Use			
Roofprint:	6,000	sq. ft.		Roofprint:	6,000	sq. ft.		Roofprint:	6,000	sq. ft.	
Cistern size:	55,000	gallons		Cistern size:	55,000	gallons		Cistern size:	55,000	gallons	
Curtailment vol:	7,200	gallons		Curtailment vol:	7,200	gallons		Curtailment vol:	7,200	gallons	
Curtailment rate:	0.7	+ irr.		Curtailment rate:	0.7	+ irr.		Curtailment rate:	0.7	+ irr.	
Occupancy:	4	persons		Occupancy:	4	persons		Occupancy:	4	persons	
Usage rate:	60	gpcd		Usage rate:	60	gpcd		Usage rate:	60	gpcd	
Daily use:	240	gpd		Daily use:	240	gpd		Daily use:	240	gpd	
Backup Water Required				Backup Water Required				Backup Water Required			
Year	Amount (gallons)	% of total usage		Year	Amount (gallons)	% of total usage		Year	Amount (gallons)	% of total usage	
2009	2,000	8		Backup water required in 2 years				Total:	4,000		
Total:	2,000			2nd most =	6,000	in	2009				
System Size & Water Use				System Size & Water Use				System Size & Water Use			
Roofprint:	7,500	sq. ft.		Roofprint:	7,500	sq. ft.		Roofprint:	7,500	sq. ft.	
Cistern size:	55,000	gallons		Cistern size:	55,000	gallons		Cistern size:	55,000	gallons	
Occupancy:	4	persons		Occupancy:	4	persons		Occupancy:	4	persons	
Usage rate:	50	gpcd		Usage rate:	45	gpcd		Usage rate:	40	gpcd	
Daily use:	200	gpd		Daily use:	180	gpd		Daily use:	160	gpd	
Backup Water Required				Backup Water Required				Backup Water Required			
Year	Amount (gallons)	% of total usage		Year	Amount (gallons)	% of total usage		Year	Amount (gallons)	% of total usage	
2009	10,000	10		Backup water required in 10 years				2011	2,000	2	
2011	18,000	17		Max yr. =	10,000	in		Total:	2,000		
Total:	28,000			2nd most =	10,000	in					
System Size & Water Use				System Size & Water Use				System Size & Water Use			
Roofprint:	7,500	sq. ft.		Roofprint:	7,500	sq. ft.		Roofprint:	7,500	sq. ft.	
Cistern size:	55,000	gallons		Cistern size:	55,000	gallons		Cistern size:	55,000	gallons	
Curtailment vol:	6,000	gallons		Curtailment vol:	6,000	gallons		Curtailment vol:	6,000	gallons	
Curtailment rate:	1.0	irr. only		Curtailment rate:	1.0	irr. only		Curtailment rate:	1.0	irr. only	
Occupancy:	4	persons		Occupancy:	4	persons		Occupancy:	4	persons	
Usage rate:	50	gpcd		Usage rate:	45	gpcd		Usage rate:	40	gpcd	
Daily use:	200	gpd		Daily use:	180	gpd		Daily use:	160	gpd	
Backup Water Required				Backup Water Required				Backup Water Required			
Year	Amount (gallons)	% of total usage		Year	Amount (gallons)	% of total usage		Year	Amount (gallons)	% of total usage	
2009	4,000	4		Backup water required in 4 years				NONE required			
2011	4,000	4		Max yr. =	4,000	in					
Total:	8,000			2nd most =	4,000	in					

Appendix D – Boerne Rainwater Harvesting Modeling Summary

Boerne Rainwater Harvesting Model Summary				Boerne Rainwater Harvesting Model Summary				Boerne Rainwater Harvesting Model Summary			
Interior Use Only				Interior Use & Irrigation				Interior Use & Irrigation with Wastewater Reuse			
House with 2 person occupancy				House with 2 person occupancy, 1200 sq. ft. irrigated area				House with 2 person occupancy, 1200 sq. ft. irrigated area			
System Size & Water Use				System Size & Water Use				System Size & Water Use			
Roofprint:	2,500	sq. ft.		Roofprint:	2,500	sq. ft.		Roofprint:	2,500	sq. ft.	
Cistern size:	15,000	gallons		Cistern size:	15,000	gallons		Cistern size:	15,000	gallons	
Occupancy:	2	persons		Occupancy:	2	persons		Occupancy:	2	persons	
Usage rate:	50	gpcd		Usage rate:	50	gpcd		Usage rate:	50	gpcd	
Daily use:	100	gpd		Daily use:	100	gpd		Daily use:	100	gpd	
Backup Water Required				Backup Water Required				Backup Water Required			
Year	Amount (gallons)	% of total usage		Year	Amount (gallons)	% of total usage		Year	Amount (gallons)	% of total usage	
2000	4,000	11		2000	4,000	11		2000	4,000	11	
2008	10,000	27		2008	10,000	27		2008	10,000	27	
2009	6,000	16		2009	6,000	16		2009	6,000	21	
2011	10,000	27		2011	10,000	27		2011	12,000	31	
Total:	30,000			Total:	30,000			Total:	34,000		

Boerne Rainwater Harvesting Model Summary				Boerne Rainwater Harvesting Model Summary				Boerne Rainwater Harvesting Model Summary			
Interior Use Only				Interior Use & Irrigation				Interior Use & Irrigation with Wastewater Reuse			
House with 2.5 person occupancy				House with 2.5 person occupancy, 1500 sq. ft. irrigated area				House with 2.5 person occupancy, 1500 sq. ft. irrigated area			
System Size & Water Use		Backup Water Required		System Size & Water Use		Backup Water Required		System Size & Water Use		Backup Water Required	
Roofprint:	3,500 sq. ft.	Year	Amount (gallons)	% of total usage	Roofprint:	3,500 sq. ft.	Year	Amount (gallons)	% of total usage	Roofprint:	3,500 sq. ft.
Cistern size:	20,000 gallons	2008	6,000	13	Cistern size:	20,000 gallons	2009	6,000	13	Cistern size:	20,000 gallons
Occupancy:	2.5 persons	2011	10,000	22	Occupancy:	2.5 persons	Total	22,000		Occupancy:	2.5 persons
Usage rate:	50 gpcd				Usage rate:	50 gpcd				Usage rate:	50 gpcd
Daily use:	125 gpd				Daily use:	125 gpd				Daily use:	125 gpd
System Size & Water Use		Backup Water Required		System Size & Water Use		Backup Water Required		System Size & Water Use		Backup Water Required	
Roofprint:	3,500 sq. ft.	Year	Amount (gallons)	% of total usage	Roofprint:	3,500 sq. ft.	Year	Amount (gallons)	% of total usage	Roofprint:	3,500 sq. ft.
Cistern size:	20,000 gallons	2008	2,000	5	Cistern size:	20,000 gallons	2009	4,000	10	Cistern size:	20,000 gallons
Occupancy:	2.5 persons	2011	4,000	10	Occupancy:	2.5 persons	Total	10,000		Occupancy:	2.5 persons
Usage rate:	45 gpcd				Usage rate:	45 gpcd				Usage rate:	45 gpcd
Daily use:	112.5 gpd				Daily use:	112.5 gpd				Daily use:	112.5 gpd
System Size & Water Use		Backup Water Required		System Size & Water Use		Backup Water Required		System Size & Water Use		Backup Water Required	
Roofprint:	3,500 sq. ft.	Year	Amount (gallons)	% of total usage	Roofprint:	3,500 sq. ft.	Year	Amount (gallons)	% of total usage	Roofprint:	3,500 sq. ft.
Cistern size:	20,000 gallons	2011	2,000	5	Cistern size:	20,000 gallons	2009	2,000	5	Cistern size:	20,000 gallons
Occupancy:	2.5 persons	Total	2,000		Occupancy:	2.5 persons	2011	4,000	10	Occupancy:	2.5 persons
Usage rate:	40 gpcd				Usage rate:	40 gpcd				Usage rate:	40 gpcd
Daily use:	100 gpd				Daily use:	100 gpd				Daily use:	100 gpd
System Size & Water Use		Backup Water Required		System Size & Water Use		Backup Water Required		System Size & Water Use		Backup Water Required	
Roofprint:	3,500 sq. ft.	Year	Amount (gallons)	% of total usage	Roofprint:	3,500 sq. ft.	Year	Amount (gallons)	% of total usage	Roofprint:	3,500 sq. ft.
Cistern size:	20,000 gallons	2008	2,000	5	Cistern size:	20,000 gallons	2009	2,000	5	Cistern size:	20,000 gallons
Curtailment vol:	3,750 gallons	2009	4,000	9	Curtailment vol:	3,750 gallons	2011	4,000	10	Curtailment vol:	3,750 gallons
Curtailment rate:	0.7 + irr.	2011	4,000	10	Curtailment rate:	0.7 + irr.	Total	10,000		Curtailment rate:	0.7 + irr.
Occupancy:	2.5 persons				Occupancy:	2.5 persons				Occupancy:	2.5 persons
Usage rate:	50 gpcd				Usage rate:	50 gpcd				Usage rate:	50 gpcd
Daily use:	125 gpd				Daily use:	125 gpd				Daily use:	125 gpd

Boerne Rainwater Harvesting Model Summary				Boerne Rainwater Harvesting Model Summary				Boerne Rainwater Harvesting Model Summary			
Interior Use Only				Interior Use & Irrigation				Interior Use & Irrigation with Wastewater Reuse			
House with 3 person occupancy				House with 3 person occupancy, 1800 sq. ft. irrigated area				House with 3 person occupancy, 1800 sq. ft. irrigated area			
System Size & Water Use		Backup Water Required		System Size & Water Use		Backup Water Required		System Size & Water Use		Backup Water Required	
Roofprint:	4,000 sq. ft.	Year	Amount (gallons)	% of total usage	Roofprint:	4,000 sq. ft.	Year	Amount (gallons)	% of total usage	Roofprint:	4,000 sq. ft.
Cistern size:	20,000 gallons	2000	4,000	7	Cistern size:	20,000 gallons	2008	6,000	11	Cistern size:	20,000 gallons
Occupancy:	3 persons	2008	12,000	22	Occupancy:	3 persons	2009	12,000	22	Occupancy:	3 persons
Usage rate:	50 gpcd	2011	16,000	29	Usage rate:	50 gpcd	2011	16,000	29	Usage rate:	50 gpcd
Daily use:	150 gpd	Total	36,000		Daily use:	150 gpd	Total	46,000		Daily use:	150 gpd
System Size & Water Use		Backup Water Required		System Size & Water Use		Backup Water Required		System Size & Water Use		Backup Water Required	
Roofprint:	4,000 sq. ft.	Year	Amount (gallons)	% of total usage	Roofprint:	4,000 sq. ft.	Year	Amount (gallons)	% of total usage	Roofprint:	4,000 sq. ft.
Cistern size:	20,000 gallons	2008	6,000	12	Cistern size:	20,000 gallons	2000	2,000	4	Cistern size:	20,000 gallons
Occupancy:	3 persons	2009	4,000	8	Occupancy:	3 persons	2008	6,000	12	Occupancy:	3 persons
Usage rate:	45 gpcd	2011	10,000	20	Usage rate:	45 gpcd	2009	8,000	15	Usage rate:	45 gpcd
Daily use:	135 gpd	Total	20,000		Daily use:	135 gpd	2011	14,000	26	Daily use:	135 gpd
System Size & Water Use		Backup Water Required		System Size & Water Use		Backup Water Required		System Size & Water Use		Backup Water Required	
Roofprint:	4,000 sq. ft.	Year	Amount (gallons)	% of total usage	Roofprint:	4,000 sq. ft.	Year	Amount (gallons)	% of total usage	Roofprint:	4,000 sq. ft.
Cistern size:	20,000 gallons	2009	4,000	9	Cistern size:	20,000 gallons	2008	2,000	4	Cistern size:	20,000 gallons
Occupancy:	3 persons	2011	4,000	9	Occupancy:	3 persons	2009	6,000	13	Occupancy:	3 persons
Usage rate:	40 gpcd	Total	8,000		Usage rate:	40 gpcd	2011	10,000	20	Usage rate:	40 gpcd
Daily use:	120 gpd				Daily use:	120 gpd				Daily use:	120 gpd
System Size & Water Use		Backup Water Required		System Size & Water Use		Backup Water Required		System Size & Water Use		Backup Water Required	
Roofprint:	4,000 sq. ft.	Year	Amount (gallons)	% of total usage	Roofprint:	4,000 sq. ft.	Year	Amount (gallons)	% of total usage	Roofprint:	4,000 sq. ft.
Cistern size:	20,000 gallons	2008	4,000	9	Cistern size:	20,000 gallons	2008	4,000	9	Cistern size:	20,000 gallons
Curtailment vol:	4,500 gallons	2009	4,000	8	Curtailment vol:	4,500 gallons	2009	6,000	12	Curtailment vol:	4,500 gallons
Curtailment rate:	0.7 + irr.	2011	8,000	18	Curtailment rate:	0.7 + irr.	2011	8,000	18	Curtailment rate:	0.7 + irr.
Occupancy:	3 persons	Total	16,000		Occupancy:	3 persons	Total	14,000		Occupancy:	3 persons
Usage rate:	50 gpcd				Usage rate:	50 gpcd				Usage rate:	50 gpcd
Daily use:	150 gpd				Daily use:	150 gpd				Daily use:	150 gpd

Boerne Rainwater Harvesting Model Summary
Interior Use Only

House with 3 person occupancy			
System Size & Water Use			
Roofprint:	4,000 sq. ft.		
Cistern size:	25,000 gallons		
Occupancy:	3 persons		
Usage rate:	50 gpcd		
Daily use:	150 gpd		
Backup Water Required			
Year	Amount (gallons)	% of total usage	
2008	6,000	11	
2009	10,000	18	
2011	10,000	18	
Total:	26,000		

Boerne Rainwater Harvesting Model Summary
Interior Use & Irrigation

House with 3 person occupancy, 1800 sq. ft. irrigated area			
System Size & Water Use			
Roofprint:	4,000 sq. ft.		
Cistern size:	25,000 gallons		
Occupancy:	3 persons		
Usage rate:	50 gpcd		
Daily use:	150 gpd		
Backup Water Required			
Year	Amount (gallons)	% of total usage	
Backup water required in 10 years			
Max yr. =	36,000 in	2011	
2nd most =	30,000 in	2008	
Total req. =	160,000 gallons		

Boerne Rainwater Harvesting Model Summary
Interior Use & Irrigation with Wastewater Reuse

House with 3 person occupancy, 1800 sq. ft. irrigated area			
System Size & Water Use			
Roofprint:	4,000 sq. ft.		
Cistern size:	25,000 gallons		
Occupancy:	3 persons		
Usage rate:	50 gpcd		
Daily use:	150 gpd		
Backup Water Required			
Year	Amount (gallons)	% of total usage	
2008	8,000	14	
2009	10,000	18	
2011	14,000	24	
Total:	32,000		

Boerne Rainwater Harvesting Model Summary
Interior Use Only

House with 4 person occupancy			
System Size & Water Use			
Roofprint:	4,500 sq. ft.		
Cistern size:	25,000 gallons		
Occupancy:	3 persons		
Usage rate:	50 gpcd		
Daily use:	150 gpd		
Backup Water Required			
Year	Amount (gallons)	% of total usage	
2008	4,000	8	
2009	4,000	8	
2011	4,000	9	
Total:	12,000		

Boerne Rainwater Harvesting Model Summary
Interior Use & Irrigation

House with 4 person occupancy, 2400 sq. ft. irrigated area			
System Size & Water Use			
Roofprint:	4,500 sq. ft.		
Cistern size:	25,000 gallons		
Occupancy:	3 persons		
Usage rate:	50 gpcd		
Daily use:	150 gpd		
Backup Water Required			
Year	Amount (gallons)	% of total usage	
Backup water required in 10 years			
Max yr. =	10,000 in	2009	
2nd most =	8,000 in	2008	
Total req. =	42,000 gallons		

Boerne Rainwater Harvesting Model Summary
Interior Use & Irrigation with Wastewater Reuse

House with 4 person occupancy, 2400 sq. ft. irrigated area			
System Size & Water Use			
Roofprint:	4,500 sq. ft.		
Cistern size:	25,000 gallons		
Occupancy:	3 persons		
Usage rate:	50 gpcd		
Daily use:	150 gpd		
Backup Water Required			
Year	Amount (gallons)	% of total usage	
2008	4,000	8	
2009	6,000	12	
2011	4,000	9	
Total:	14,000		

Boerne Rainwater Harvesting Model Summary
Interior Use Only

House with 4 person occupancy			
System Size & Water Use			
Roofprint:	4,500 sq. ft.		
Cistern size:	35,000 gallons		
Occupancy:	4 persons		
Usage rate:	50 gpcd		
Daily use:	200 gpd		
Backup Water Required			
Year	Amount (gallons)	% of total usage	
2000	4,000	5	
2008	14,000	19	
2009	18,000	25	
2011	16,000	22	
Total:	52,000		

Boerne Rainwater Harvesting Model Summary
Interior Use & Irrigation

House with 4 person occupancy, 2400 sq. ft. irrigated area			
System Size & Water Use			
Roofprint:	4,500 sq. ft.		
Cistern size:	35,000 gallons		
Occupancy:	4 persons		
Usage rate:	50 gpcd		
Daily use:	200 gpd		
Backup Water Required			
Year	Amount (gallons)	% of total usage	
Backup water required in 13 years			
Max yr. =	52,000 in	2011	
2nd most =	48,000 in	2008	
Total req. =	302,000 gallons		

Boerne Rainwater Harvesting Model Summary
Interior Use & Irrigation with Wastewater Reuse

House with 4 person occupancy, 2400 sq. ft. irrigated area			
System Size & Water Use			
Roofprint:	4,500 sq. ft.		
Cistern size:	35,000 gallons		
Occupancy:	4 persons		
Usage rate:	50 gpcd		
Daily use:	200 gpd		
Backup Water Required			
Year	Amount (gallons)	% of total usage	
1989	2,000	3	
1990	2,000	3	
2000	4,000	5	
2008	16,000	22	
2009	18,000	24	
2011	20,000	26	
Total:	62,000		

Boerne Rainwater Harvesting Model Summary
Interior Use Only

House with 4 person occupancy			
Backup Water Required			
System Size & Water Use			
Year	Amount (gallons)	% of total usage	
2008	10,000	14	
2009	16,000	22	
2011	10,000	14	
Total:	36,000		

System Size & Water Use			
Year	Amount (gallons)	% of total usage	
2008	2,000	3	
2009	10,000	15	
2011	4,000	6	
Total:	16,000		

System Size & Water Use			
Year	Amount (gallons)	% of total usage	
NONE required			

System Size & Water Use			
Year	Amount (gallons)	% of total usage	
2008	4,000	6	
2009	8,000	13	
2011	6,000	9	
Total:	18,000		

Boerne Rainwater Harvesting Model Summary
Interior Use & Irrigation

House with 4 person occupancy, 2400 sq. ft. irrigated area			
Backup Water Required			
System Size & Water Use			
Year	Amount (gallons)	% of total usage	
Backup water required in 11 years			
Max yr. =	46,000 in	2011	
2nd most =	42,000 in	2008	
Total req. =	270,000	gallons	

System Size & Water Use			
Year	Amount (gallons)	% of total usage	
Backup water required in 9 years			
Max yr. =	38,000 in	2011	
2nd most =	34,000 in	2 years	
Total req. =	188,000	gallons	

System Size & Water Use			
Year	Amount (gallons)	% of total usage	
Backup water required in 7 years			
Max yr. =	32,000 in	2011	
2nd most =	28,000 in	2009	
Total req. =	120,000	gallons	

System Size & Water Use			
Year	Amount (gallons)	% of total usage	
Backup water required in 10 years			
Max yr. =	14,000 in	2009	
2nd most =	12,000 in	2011	
Total req. =	78,000	gallons	

Boerne Rainwater Harvesting Model Summary
Interior Use & Irrigation with Wastewater Reuse

House with 4 person occupancy, 2400 sq. ft. irrigated area			
Backup Water Required			
System Size & Water Use			
Year	Amount (gallons)	% of total usage	
2000	2,000	3	
2008	10,000	13	
2009	20,000	27	
2011	14,000	18	
Total:	46,000		

System Size & Water Use			
Year	Amount (gallons)	% of total usage	
2008	2,000	3	
2009	16,000	23	
2011	10,000	14	
Total:	28,000		

System Size & Water Use			
Year	Amount (gallons)	% of total usage	
2009	8,000	13	
2011	4,000	6	
Total:	12,000		

System Size & Water Use			
Year	Amount (gallons)	% of total usage	
2008	4,000	6	
2009	8,000	13	
2011	6,000	9	
Total:	18,000		

Boerne Rainwater Harvesting Model Summary
Interior Use Only

House with 4 person occupancy			
Backup Water Required			
System Size & Water Use			
Year	Amount (gallons)	% of total usage	
2008	4,000	5	
2009	14,000	19	
2011	8,000	11	
Total:	26,000		

System Size & Water Use			
Year	Amount (gallons)	% of total usage	
2009	6,000	9	
2011	2,000	3	
Total:	8,000		

System Size & Water Use			
Year	Amount (gallons)	% of total usage	
None required			

System Size & Water Use			
Year	Amount (gallons)	% of total usage	
2008	2,000	3	
2009	6,000	10	
2011	6,000	9	
Total:	14,000		

Boerne Rainwater Harvesting Model Summary
Interior Use & Irrigation

House with 4 person occupancy, 2400 sq. ft. irrigated area			
Backup Water Required			
System Size & Water Use			
Year	Amount (gallons)	% of total usage	
Backup water required in 9 years			
Max yr. =	44,000 in	2011	
2nd most =	38,000 in	2008	
Total req. =	204,000	gallons	

System Size & Water Use			
Year	Amount (gallons)	% of total usage	
Backup water required in 7 years			
Max yr. =	36,000 in	2011	
2nd most =	30,000 in	2009	
Total req. =	136,000	gallons	

System Size & Water Use			
Year	Amount (gallons)	% of total usage	
Backup water required in 4 years			
Max yr. =	28,000 in	2011	
2nd most =	24,000 in	2009	
Total req. =	82,000	gallons	

System Size & Water Use			
Year	Amount (gallons)	% of total usage	
Backup water required in 9 years			
Max yr. =	12,000 in	2009	
2nd most =	8,000 in	2 years	
Total req. =	48,000	gallons	

Boerne Rainwater Harvesting Model Summary
Interior Use & Irrigation with Wastewater Reuse

House with 4 person occupancy, 2400 sq. ft. irrigated area			
Backup Water Required			
System Size & Water Use			
Year	Amount (gallons)	% of total usage	
2008	6,000	8	
2009	16,000	21	
2011	12,000	16	
Total:	34,000		

System Size & Water Use			
Year	Amount (gallons)	% of total usage	
2009	10,000	14	
2011	6,000	8	
Total:	16,000		

System Size & Water Use			
Year	Amount (gallons)	% of total usage	
Backup water required in 4 years			
Max yr. =	28,000 in	2011	
2nd most =	24,000 in	2009	
Total req. =	82,000	gallons	

System Size & Water Use			
Year	Amount (gallons)	% of total usage	
1994	2,000	3	
2009	8,000	13	
2011	4,000	6	
Total:	14,000		

Boerne Rainwater Harvesting Model Summary				Boerne Rainwater Harvesting Model Summary				Boerne Rainwater Harvesting Model Summary			
Interior Use Only				Interior Use & Irrigation				Interior Use & Irrigation with Wastewater Reuse			
House with 4 person occupancy				House with 4 person occupancy, 2400 sq. ft. irrigated area				House with 4 person occupancy, 2400 sq. ft. irrigated area			
System Size & Water Use				System Size & Water Use				System Size & Water Use			
Roofprint:	5,500	sq. ft.		Roofprint:	5,500	sq. ft.		Roofprint:	5,500	sq. ft.	
Cistern size:	50,000	gallons		Cistern size:	50,000	gallons		Cistern size:	50,000	gallons	
Occupancy:	4	persons		Occupancy:	4	persons		Occupancy:	4	persons	
Usage rate:	60	gpcd		Usage rate:	60	gpcd		Usage rate:	60	gpcd	
Daily use:	240	gpd		Daily use:	240	gpd		Daily use:	240	gpd	
Backup Water Required				Backup Water Required				Backup Water Required			
Year	Amount (gallons)	% of total usage		Year	Amount (gallons)	% of total usage		Year	Amount (gallons)	% of total usage	
2008	8,000	9		2008	8,000	9		2008	8,000	9	
2009	20,000	23		2009	20,000	23		2009	20,000	23	
2011	10,000	11		2011	10,000	11		2011	10,000	11	
Total:	38,000			Total:	38,000			Total:	38,000		
System Size & Water Use				System Size & Water Use				System Size & Water Use			
Roofprint:	5,500	sq. ft.		Roofprint:	5,500	sq. ft.		Roofprint:	5,500	sq. ft.	
Cistern size:	50,000	gallons		Cistern size:	50,000	gallons		Cistern size:	50,000	gallons	
Curtailment vol:	7,200	gallons		Curtailment vol:	7,200	gallons		Curtailment vol:	7,200	gallons	
Curtailment rate:	0.7	+ irr.		Curtailment rate:	0.7	+ irr.		Curtailment rate:	0.7	+ irr.	
Occupancy:	4	persons		Occupancy:	4	persons		Occupancy:	4	persons	
Usage rate:	60	gpcd		Usage rate:	60	gpcd		Usage rate:	60	gpcd	
Daily use:	240	gpd		Daily use:	240	gpd		Daily use:	240	gpd	
Backup Water Required				Backup Water Required				Backup Water Required			
Year	Amount (gallons)	% of total usage		Year	Amount (gallons)	% of total usage		Year	Amount (gallons)	% of total usage	
2008	4,000	5		2008	4,000	5		2008	4,000	5	
2009	8,000	11		2009	8,000	11		2009	8,000	11	
2011	4,000	5		2011	4,000	5		2011	4,000	5	
Total:	16,000			Total:	16,000			Total:	16,000		
System Size & Water Use				System Size & Water Use				System Size & Water Use			
Roofprint:	6,000	sq. ft.		Roofprint:	6,000	sq. ft.		Roofprint:	6,000	sq. ft.	
Cistern size:	55,000	gallons		Cistern size:	55,000	gallons		Cistern size:	55,000	gallons	
Occupancy:	4	persons		Occupancy:	4	persons		Occupancy:	4	persons	
Usage rate:	60	gpcd		Usage rate:	60	gpcd		Usage rate:	60	gpcd	
Daily use:	240	gpd		Daily use:	240	gpd		Daily use:	240	gpd	
Backup Water Required				Backup Water Required				Backup Water Required			
Year	Amount (gallons)	% of total usage		Year	Amount (gallons)	% of total usage		Year	Amount (gallons)	% of total usage	
2009	14,000	16		2009	14,000	16		2009	14,000	16	
2011	2,000	2		2011	2,000	2		2011	2,000	2	
Total:	16,000			Total:	16,000			Total:	16,000		
System Size & Water Use				System Size & Water Use				System Size & Water Use			
Roofprint:	6,000	sq. ft.		Roofprint:	6,000	sq. ft.		Roofprint:	6,000	sq. ft.	
Cistern size:	55,000	gallons		Cistern size:	55,000	gallons		Cistern size:	55,000	gallons	
Curtailment vol:	7,200	gallons		Curtailment vol:	7,200	gallons		Curtailment vol:	7,200	gallons	
Curtailment rate:	0.7	+ irr.		Curtailment rate:	0.7	+ irr.		Curtailment rate:	0.7	+ irr.	
Occupancy:	4	persons		Occupancy:	4	persons		Occupancy:	4	persons	
Usage rate:	60	gpcd		Usage rate:	60	gpcd		Usage rate:	60	gpcd	
Daily use:	240	gpd		Daily use:	240	gpd		Daily use:	240	gpd	
Backup Water Required				Backup Water Required				Backup Water Required			
Year	Amount (gallons)	% of total usage		Year	Amount (gallons)	% of total usage		Year	Amount (gallons)	% of total usage	
2009	6,000	8		2009	6,000	8		2009	6,000	8	
2011	2,000	2		2011	2,000	2		2011	2,000	2	
Total:	8,000			Total:	8,000			Total:	8,000		

Requirements for house with 4 person occupancy, 2400 sq. ft. irrigated area with no wastewater irrigation											
System Size & Water Use				System Size & Water Use				System Size & Water Use			
Roofprint:	7,500	sq. ft.		Roofprint:	7,500	sq. ft.		Roofprint:	7,500	sq. ft.	
Cistern size:	55,000	gallons		Cistern size:	55,000	gallons		Cistern size:	55,000	gallons	
Occupancy:	4	persons		Occupancy:	4	persons		Occupancy:	4	persons	
Usage rate:	50	gpcd		Usage rate:	45	gpcd		Usage rate:	40	gpcd	
Daily use:	200	gpd		Daily use:	180	gpd		Daily use:	160	gpd	
Backup Water Required				Backup Water Required				Backup Water Required			
Year	Amount (gallons)	% of total usage		Year	Amount (gallons)	% of total usage		Year	Amount (gallons)	% of total usage	
2009	16,000	17		2009	2,000	2		2009	2,000	2	
2011	16,000	15		2011	10,000	10		2011	2,000	2	
Total:	32,000			Total:	12,000			Total:	2,000		
System Size & Water Use				System Size & Water Use				System Size & Water Use			
Roofprint:	7,500	sq. ft.		Roofprint:	7,500	sq. ft.		Roofprint:	7,500	sq. ft.	
Cistern size:	55,000	gallons		Cistern size:	55,000	gallons		Cistern size:	55,000	gallons	
Curtailment vol:	6,000	gallons		Curtailment vol:	6,000	gallons		Curtailment vol:	6,000	gallons	
Curtailment rate:	1.0	irr. only		Curtailment rate:	1.0	irr. only		Curtailment rate:	1.0	irr. only	
Occupancy:	4	persons		Occupancy:	4	persons		Occupancy:	4	persons	
Usage rate:	50	gpcd		Usage rate:	45	gpcd		Usage rate:	40	gpcd	
Daily use:	200	gpd		Daily use:	180	gpd		Daily use:	160	gpd	
Backup Water Required				Backup Water Required				Backup Water Required			
Year	Amount (gallons)	% of total usage		Year	Amount (gallons)	% of total usage		Year	Amount (gallons)	% of total usage	
2009	10,000	11		2009	2,000	2		2009	2,000	2	
2011	6,000	6		2011	8,000	8		2011	2,000	2	
Total:	16,000			Total:	10,000			Total:	2,000		

Appendix E – Burnet Rainwater Harvesting Modeling Summary

Burnet Rainwater Harvesting Model Summary					Burnet Rainwater Harvesting Model Summary					Burnet Rainwater Harvesting Model Summary							
Interior Use Only					Interior Use & Irrigation					Interior Use & Irrigation with Wastewater Reuse							
House with 2 person occupancy					House with 2 person occupancy, 1200 sq. ft. irrigated area					House with 2 person occupancy, 1200 sq. ft. irrigated area							
Backup Water Required					Backup Water Required					Backup Water Required							
System Size & Water Use			Year	Amount (gallons)	% of total usage	System Size & Water Use			Year	Amount (gallons)	% of total usage	System Size & Water Use			Year	Amount (gallons)	% of total usage
Roofprint:	2,500	sq. ft.	1990	2,000	5	Roofprint:	2,500	sq. ft.	1990	2,000	5	Roofprint:	2,500	sq. ft.	1989	2,000	5
Cistern size:	15,000	gallons	2008	2,000	5	Cistern size:	15,000	gallons	2008	2,000	5	Cistern size:	15,000	gallons	2009	2,000	6
Occupancy:	2	persons	2009	6,000	16	Occupancy:	2	persons	2009	6,000	16	Occupancy:	2	persons	2009	4,000	11
Usage rate:	50	gpcd	2011	8,000	22	Usage rate:	50	gpcd	2011	8,000	22	Usage rate:	50	gpcd	2009	4,000	11
Daily use:	100	gpd	Total:	16,000		Daily use:	100	gpd	Total:	16,000		Daily use:	100	gpd	Total:	10,000	26
Backup Water Required					Backup Water Required					Backup Water Required							
System Size & Water Use			Year	Amount (gallons)	% of total usage	System Size & Water Use			Year	Amount (gallons)	% of total usage	System Size & Water Use			Year	Amount (gallons)	% of total usage
Roofprint:	2,500	sq. ft.	1990	2,000	6	Roofprint:	2,500	sq. ft.	1990	2,000	6	Roofprint:	2,500	sq. ft.	1989	2,000	6
Cistern size:	15,000	gallons	2009	2,000	6	Cistern size:	15,000	gallons	2009	2,000	6	Cistern size:	15,000	gallons	2009	2,000	6
Occupancy:	2	persons	2011	4,000	12	Occupancy:	2	persons	2011	4,000	12	Occupancy:	2	persons	2011	6,000	17
Usage rate:	45	gpcd	Total:	6,000		Usage rate:	45	gpcd	Total:	6,000		Usage rate:	45	gpcd	Total:	10,000	
Daily use:	90	gpd				Daily use:	90	gpd				Daily use:	90	gpd			
Backup Water Required					Backup Water Required					Backup Water Required							
System Size & Water Use			Year	Amount (gallons)	% of total usage	System Size & Water Use			Year	Amount (gallons)	% of total usage	System Size & Water Use			Year	Amount (gallons)	% of total usage
Roofprint:	2,500	sq. ft.	2011	2,000	7	Roofprint:	2,500	sq. ft.	2011	2,000	7	Roofprint:	2,500	sq. ft.	2011	4,000	12
Cistern size:	15,000	gallons	Total:	2,000		Cistern size:	15,000	gallons	Total:	2,000		Cistern size:	15,000	gallons	Total:	4,000	
Occupancy:	2	persons				Occupancy:	2	persons				Occupancy:	2	persons			
Usage rate:	40	gpcd				Usage rate:	40	gpcd				Usage rate:	40	gpcd			
Daily use:	80	gpd				Daily use:	80	gpd				Daily use:	80	gpd			
Backup Water Required					Backup Water Required					Backup Water Required							
System Size & Water Use			Year	Amount (gallons)	% of total usage	System Size & Water Use			Year	Amount (gallons)	% of total usage	System Size & Water Use			Year	Amount (gallons)	% of total usage
Roofprint:	2,500	sq. ft.	1990	2,000	6	Roofprint:	2,500	sq. ft.	1990	2,000	6	Roofprint:	2,500	sq. ft.	1989	2,000	5
Cistern size:	15,000	gallons	2008	2,000	6	Cistern size:	15,000	gallons	2008	2,000	6	Cistern size:	15,000	gallons	1990	2,000	5
Occupancy:	2	persons	2009	2,000	6	Occupancy:	2	persons	2009	2,000	6	Occupancy:	2	persons	2008	2,000	6
Usage rate:	50	gpcd	2011	6,000	18	Usage rate:	50	gpcd	2011	6,000	18	Usage rate:	50	gpcd	2009	2,000	6
Daily use:	100	gpd	Total:	10,000		Daily use:	100	gpd	Total:	10,000		Daily use:	100	gpd	Total:	6,000	18
Backup Water Required					Backup Water Required					Backup Water Required							
System Size & Water Use			Year	Amount (gallons)	% of total usage	System Size & Water Use			Year	Amount (gallons)	% of total usage	System Size & Water Use			Year	Amount (gallons)	% of total usage
Roofprint:	3,000	sq. ft.	1990	2,000	5	Roofprint:	3,000	sq. ft.	1990	2,000	5	Roofprint:	3,000	sq. ft.	1990	2,000	5
Cistern size:	15,000	gallons	2011	4,000	11	Cistern size:	15,000	gallons	2011	4,000	11	Cistern size:	15,000	gallons	2011	6,000	16
Occupancy:	2	persons	Total:	6,000		Occupancy:	2	persons	Total:	6,000		Occupancy:	2	persons	Total:	8,000	
Usage rate:	50	gpcd				Usage rate:	50	gpcd				Usage rate:	50	gpcd			
Daily use:	100	gpd				Daily use:	100	gpd				Daily use:	100	gpd			
Backup Water Required					Backup Water Required					Backup Water Required							
System Size & Water Use			Year	Amount (gallons)	% of total usage	System Size & Water Use			Year	Amount (gallons)	% of total usage	System Size & Water Use			Year	Amount (gallons)	% of total usage
Roofprint:	3,000	sq. ft.	2011	2,000	6	Roofprint:	3,000	sq. ft.	2011	2,000	6	Roofprint:	3,000	sq. ft.	2011	4,000	11
Cistern size:	15,000	gallons	Total:	2,000		Cistern size:	15,000	gallons	Total:	2,000		Cistern size:	15,000	gallons	Total:	4,000	
Occupancy:	2	persons				Occupancy:	2	persons				Occupancy:	2	persons			
Usage rate:	45	gpcd				Usage rate:	45	gpcd				Usage rate:	45	gpcd			
Daily use:	90	gpd				Daily use:	90	gpd				Daily use:	90	gpd			
Backup Water Required					Backup Water Required					Backup Water Required							
System Size & Water Use			Year	Amount (gallons)	% of total usage	System Size & Water Use			Year	Amount (gallons)	% of total usage	System Size & Water Use			Year	Amount (gallons)	% of total usage
Roofprint:	3,000	sq. ft.	NONE required			Roofprint:	3,000	sq. ft.	NONE required			Roofprint:	3,000	sq. ft.	2011	2,000	6
Cistern size:	15,000	gallons				Cistern size:	15,000	gallons				Cistern size:	15,000	gallons	2011	2,000	6
Occupancy:	2	persons				Occupancy:	2	persons				Occupancy:	2	persons	Total:	2,000	
Usage rate:	40	gpcd				Usage rate:	40	gpcd				Usage rate:	40	gpcd			
Daily use:	80	gpd				Daily use:	80	gpd				Daily use:	80	gpd			
Backup Water Required					Backup Water Required					Backup Water Required							
System Size & Water Use			Year	Amount (gallons)	% of total usage	System Size & Water Use			Year	Amount (gallons)	% of total usage	System Size & Water Use			Year	Amount (gallons)	% of total usage
Roofprint:	3,000	sq. ft.	1990	2,000	5	Roofprint:	3,000	sq. ft.	1990	2,000	5	Roofprint:	3,000	sq. ft.	1990	2,000	5
Cistern size:	15,000	gallons	2011	4,000	12	Cistern size:	15,000	gallons	2011	4,000	12	Cistern size:	15,000	gallons	2011	6,000	16
Curtailment vol:	3,000	gallons	Total:	6,000		Curtailment vol:	3,000	gallons	Total:	6,000		Curtailment vol:	3,000	gallons	Total:	8,000	
Curtailment rate:	0.7	+ irr.				Curtailment rate:	0.7	+ irr.				Curtailment rate:	0.7	+ irr.			
Occupancy:	2	persons				Occupancy:	2	persons				Occupancy:	2	persons			
Usage rate:	50	gpcd				Usage rate:	50	gpcd				Usage rate:	50	gpcd			
Daily use:	100	gpd				Daily use:	100	gpd				Daily use:	100	gpd			

Burnet Rainwater Harvesting Model Summary					Burnet Rainwater Harvesting Model Summary					Burnet Rainwater Harvesting Model Summary				
Interior Use Only					Interior Use & Irrigation					Interior Use & Irrigation with Wastewater Reuse				
House with 2.5 person occupancy					House with 2.5 person occupancy, 1500 sq. ft. irrigated area					House with 2.5 person occupancy, 1500 sq. ft. irrigated area				
Backup Water Required					Backup Water Required					Backup Water Required				
System Size & Water Use					System Size & Water Use					System Size & Water Use				
Roofprint:	3,500	sq. ft.			Roofprint:	3,500	sq. ft.			Roofprint:	3,500	sq. ft.		
Cistern size:	20,000	gallons			Cistern size:	20,000	gallons			Cistern size:	20,000	gallons		
Occupancy:	2.5	persons			Occupancy:	2.5	persons			Occupancy:	2.5	persons		
Usage rate:	50	gpcd			Usage rate:	50	gpcd			Usage rate:	50	gpcd		
Daily use:	125	gpd			Daily use:	125	gpd			Daily use:	125	gpd		
Year					Year					Year				
Amount (gallons)					Amount (gallons)					Amount (gallons)				
% of total usage					% of total usage					% of total usage				
2009					2011					1990				
2011					Total:					2009				
Total:					Total:					2011				
8,000					2,000					8,000				
13					5					17				

Burnet Rainwater Harvesting Model Summary					Burnet Rainwater Harvesting Model Summary					Burnet Rainwater Harvesting Model Summary				
Interior Use Only					Interior Use & Irrigation					Interior Use & Irrigation with Wastewater Reuse				
House with 3 person occupancy					House with 3 person occupancy, 1800 sq. ft. irrigated area					House with 3 person occupancy, 1800 sq. ft. irrigated area				
Backup Water Required					Backup Water Required					Backup Water Required				
System Size & Water Use					System Size & Water Use					System Size & Water Use				
Roofprint:	4,000	sq. ft.			Roofprint:	4,000	sq. ft.			Roofprint:	4,000	sq. ft.		
Cistern size:	20,000	gallons			Cistern size:	20,000	gallons			Cistern size:	20,000	gallons		
Occupancy:	3	persons			Occupancy:	3	persons			Occupancy:	3	persons		
Usage rate:	50	gpcd			Usage rate:	50	gpcd			Usage rate:	50	gpcd		
Daily use:	150	gpd			Daily use:	150	gpd			Daily use:	150	gpd		
Year					Year					Year				
Amount (gallons)					Amount (gallons)					Amount (gallons)				
% of total usage					% of total usage					% of total usage				
1989					2011					1989				
1990					Total:					1990				
2008					Total:					2008				
2009					6,000					2009				
2011					12,000					2011				
Total:					22,000					Total:				
22					12					24				

Burnet Rainwater Harvesting Model Summary				Burnet Rainwater Harvesting Model Summary				Burnet Rainwater Harvesting Model Summary			
Interior Use Only				Interior Use & Irrigation				Interior Use & Irrigation with Wastewater Reuse			
House with 3 person occupancy				House with 3 person occupancy, 1800 sq. ft. irrigated area				House with 3 person occupancy, 1800 sq. ft. irrigated area			
System Size & Water Use		Backup Water Required		System Size & Water Use		Backup Water Required		System Size & Water Use		Backup Water Required	
Roofprint:	4,000 sq. ft.	Year	Amount (gallons)	% of total usage	Roofprint:	4,000 sq. ft.	Year	Amount (gallons)	% of total usage	Roofprint:	4,000 sq. ft.
Cistern size:	25,000 gallons	2009	2,000	4	Cistern size:	25,000 gallons	2011	6,000	11	Cistern size:	25,000 gallons
Occupancy:	3 persons	2011	6,000		Occupancy:	3 persons	Total:	8,000		Occupancy:	3 persons
Usage rate:	50 gpcd				Usage rate:	50 gpcd				Usage rate:	50 gpcd
Daily use:	150 gpd				Daily use:	150 gpd				Daily use:	150 gpd
System Size & Water Use		Backup Water Required		System Size & Water Use		Backup Water Required		System Size & Water Use		Backup Water Required	
Roofprint:	4,000 sq. ft.	Year	Amount (gallons)	% of total usage	Roofprint:	4,000 sq. ft.	Year	Amount (gallons)	% of total usage	Roofprint:	4,000 sq. ft.
Cistern size:	25,000 gallons	2011	2,000	4	Cistern size:	25,000 gallons	2011	4,000	8	Cistern size:	25,000 gallons
Occupancy:	3 persons	Total:	2,000		Occupancy:	3 persons	Total:	4,000		Occupancy:	3 persons
Usage rate:	45 gpcd				Usage rate:	45 gpcd				Usage rate:	45 gpcd
Daily use:	135 gpd				Daily use:	135 gpd				Daily use:	135 gpd
System Size & Water Use		Backup Water Required		System Size & Water Use		Backup Water Required		System Size & Water Use		Backup Water Required	
Roofprint:	4,000 sq. ft.	Year	Amount (gallons)	% of total usage	Roofprint:	4,000 sq. ft.	Year	Amount (gallons)	% of total usage	Roofprint:	4,000 sq. ft.
Cistern size:	25,000 gallons	NONE required			Cistern size:	25,000 gallons	2011	2,000	4	Cistern size:	25,000 gallons
Occupancy:	3 persons				Occupancy:	3 persons	Total:	2,000		Occupancy:	3 persons
Usage rate:	40 gpcd				Usage rate:	40 gpcd				Usage rate:	40 gpcd
Daily use:	120 gpd				Daily use:	120 gpd				Daily use:	120 gpd
System Size & Water Use		Backup Water Required		System Size & Water Use		Backup Water Required		System Size & Water Use		Backup Water Required	
Roofprint:	4,000 sq. ft.	Year	Amount (gallons)	% of total usage	Roofprint:	4,000 sq. ft.	Year	Amount (gallons)	% of total usage	Roofprint:	4,000 sq. ft.
Cistern size:	25,000 gallons	2009	2,000	4	Cistern size:	25,000 gallons	2011	2,000	4	Cistern size:	25,000 gallons
Curtailment vol:	4,500 gallons	2011	4,000	8	Curtailment vol:	4,500 gallons	2011	6,000	12	Curtailment vol:	4,500 gallons
Curtailment rate:	0.7 + irr.	Total:	6,000		Curtailment rate:	0.7 + irr.	Total:	8,000		Curtailment rate:	0.7 + irr.
Occupancy:	3 persons				Occupancy:	3 persons				Occupancy:	3 persons
Usage rate:	50 gpcd				Usage rate:	50 gpcd				Usage rate:	50 gpcd
Daily use:	150 gpd				Daily use:	150 gpd				Daily use:	150 gpd

Burnet Rainwater Harvesting Model Summary				Burnet Rainwater Harvesting Model Summary				Burnet Rainwater Harvesting Model Summary			
Interior Use Only				Interior Use & Irrigation				Interior Use & Irrigation with Wastewater Reuse			
House with 4 person occupancy				House with 4 person occupancy, 2400 sq. ft. irrigated area				House with 4 person occupancy, 2400 sq. ft. irrigated area			
System Size & Water Use		Backup Water Required		System Size & Water Use		Backup Water Required		System Size & Water Use		Backup Water Required	
Roofprint:	4,500 sq. ft.	Year	Amount (gallons)	% of total usage	Roofprint:	4,500 sq. ft.	Year	Amount (gallons)	% of total usage	Roofprint:	4,500 sq. ft.
Cistern size:	30,000 gallons	1988	2,000	3	Cistern size:	30,000 gallons	1988	2,000	3	Cistern size:	30,000 gallons
Occupancy:	4 persons	1990	2,000	3	Occupancy:	4 persons	1990	2,000	3	Occupancy:	4 persons
Usage rate:	50 gpcd	2008	8,000	11	Usage rate:	50 gpcd	2008	10,000	13	Usage rate:	50 gpcd
Daily use:	200 gpd	2009	10,000	14	Daily use:	200 gpd	2009	10,000	13	Daily use:	200 gpd
		2011	16,000	25			2011	22,000	29		
		Total:	38,000				Total:	48,000			
System Size & Water Use		Backup Water Required		System Size & Water Use		Backup Water Required		System Size & Water Use		Backup Water Required	
Roofprint:	4,500 sq. ft.	Year	Amount (gallons)	% of total usage	Roofprint:	4,500 sq. ft.	Year	Amount (gallons)	% of total usage	Roofprint:	4,500 sq. ft.
Cistern size:	30,000 gallons	2009	6,000	9	Cistern size:	30,000 gallons	1990	2,000	3	Cistern size:	30,000 gallons
Occupancy:	4 persons	2011	10,000	15	Occupancy:	4 persons	2008	2,000	3	Occupancy:	4 persons
Usage rate:	45 gpcd	Total:	16,000		Usage rate:	45 gpcd	2009	8,000	12	Usage rate:	45 gpcd
Daily use:	180 gpd				Daily use:	180 gpd	2011	14,000	20	Daily use:	180 gpd
							Total:	26,000			
System Size & Water Use		Backup Water Required		System Size & Water Use		Backup Water Required		System Size & Water Use		Backup Water Required	
Roofprint:	4,500 sq. ft.	Year	Amount (gallons)	% of total usage	Roofprint:	4,500 sq. ft.	Year	Amount (gallons)	% of total usage	Roofprint:	4,500 sq. ft.
Cistern size:	30,000 gallons	2011	2,000	3	Cistern size:	30,000 gallons	2011	8,000	12	Cistern size:	30,000 gallons
Occupancy:	4 persons	Total:	2,000		Occupancy:	4 persons	Total:	8,000		Occupancy:	4 persons
Usage rate:	40 gpcd				Usage rate:	40 gpcd				Usage rate:	40 gpcd
Daily use:	160 gpd				Daily use:	200 gpd				Daily use:	200 gpd
System Size & Water Use		Backup Water Required		System Size & Water Use		Backup Water Required		System Size & Water Use		Backup Water Required	
Roofprint:	4,500 sq. ft.	Year	Amount (gallons)	% of total usage	Roofprint:	4,500 sq. ft.	Year	Amount (gallons)	% of total usage	Roofprint:	4,500 sq. ft.
Cistern size:	30,000 gallons	1990	2,000	3	Cistern size:	30,000 gallons	1988	2,000	3	Cistern size:	30,000 gallons
Curtailment vol:	6,000 gallons	2008	2,000	3	Curtailment vol:	6,000 gallons	1989	2,000	3	Curtailment vol:	6,000 gallons
Curtailment rate:	0.7 + irr.	2009	4,000	6	Curtailment rate:	0.7 + irr.	1990	2,000	3	Curtailment rate:	0.7 + irr.
Occupancy:	4 persons	2011	8,000	13	Occupancy:	4 persons	2008	2,000	3	Occupancy:	4 persons
Usage rate:	50 gpcd	Total:	14,000		Usage rate:	50 gpcd	2009	6,000	9	Usage rate:	50 gpcd
Daily use:	200 gpd				Daily use:	200 gpd	2011	8,000	13	Daily use:	200 gpd
							Total:	22,000			

Burnet Rainwater Harvesting Model Summary				Burnet Rainwater Harvesting Model Summary				Burnet Rainwater Harvesting Model Summary			
Interior Use Only				Interior Use & Irrigation				Interior Use & Irrigation with Wastewater Reuse			
House with 4 person occupancy				House with 4 person occupancy, 2400 sq. ft. irrigated area				House with 4 person occupancy, 2400 sq. ft. irrigated area			
System Size & Water Use		Backup Water Required		System Size & Water Use		Backup Water Required		System Size & Water Use		Backup Water Required	
Roofprint:	4,500 sq. ft.	Year	Amount (gallons)	% of total usage	Roofprint:	4,500 sq. ft.	Year	Amount (gallons)	% of total usage	Roofprint:	4,500 sq. ft.
Cistern size:	35,000 gallons	2008	2,000	3	Cistern size:	35,000 gallons	2009	10,000	14	Cistern size:	35,000 gallons
Occupancy:	4 persons	2011	12,000	16	Occupancy:	4 persons	2011	10,000	13	Occupancy:	4 persons
Usage rate:	50 gpcd	Total:	24,000		Usage rate:	50 gpcd	Total:	16,000	21	Usage rate:	50 gpcd
Daily use:	200 gpd				Daily use:	200 gpd				Daily use:	200 gpd
System Size & Water Use		Backup Water Required		System Size & Water Use		Backup Water Required		System Size & Water Use		Backup Water Required	
Roofprint:	4,500 sq. ft.	Year	Amount (gallons)	% of total usage	Roofprint:	4,500 sq. ft.	Year	Amount (gallons)	% of total usage	Roofprint:	4,500 sq. ft.
Cistern size:	35,000 gallons	2009	2,000	3	Cistern size:	35,000 gallons	2011	4,000	6	Cistern size:	35,000 gallons
Occupancy:	4 persons	2011	4,000	6	Occupancy:	4 persons	2011	6,000	9	Occupancy:	4 persons
Usage rate:	45 gpcd	Total:	6,000		Usage rate:	45 gpcd	Total:	10,000	14	Usage rate:	45 gpcd
Daily use:	180 gpd				Daily use:	180 gpd				Daily use:	180 gpd
System Size & Water Use		Backup Water Required		System Size & Water Use		Backup Water Required		System Size & Water Use		Backup Water Required	
Roofprint:	4,500 sq. ft.	Year	Amount (gallons)	% of total usage	Roofprint:	4,500 sq. ft.	Year	Amount (gallons)	% of total usage	Roofprint:	4,500 sq. ft.
Cistern size:	35,000 gallons	NONE required			Cistern size:	35,000 gallons	2011	4,000	6	Cistern size:	35,000 gallons
Occupancy:	4 persons				Occupancy:	4 persons	Total:	4,000		Occupancy:	4 persons
Usage rate:	40 gpcd				Usage rate:	40 gpcd				Usage rate:	40 gpcd
Daily use:	160 gpd				Daily use:	160 gpd				Daily use:	160 gpd
System Size & Water Use		Backup Water Required		System Size & Water Use		Backup Water Required		System Size & Water Use		Backup Water Required	
Roofprint:	4,500 sq. ft.	Year	Amount (gallons)	% of total usage	Roofprint:	4,500 sq. ft.	Year	Amount (gallons)	% of total usage	Roofprint:	4,500 sq. ft.
Cistern size:	35,000 gallons	2008	2,000	3	Cistern size:	35,000 gallons	2008	2,000	3	Cistern size:	35,000 gallons
Curtailment vol:	6,000 gallons	2009	4,000	6	Curtailment vol:	6,000 gallons	2009	4,000	6	Curtailment vol:	6,000 gallons
Curtailment rate:	0.7 + irr.	2011	8,000	13	Curtailment rate:	0.7 + irr.	2011	10,000	15	Curtailment rate:	0.7 + irr.
Occupancy:	4 persons	Total:	14,000		Occupancy:	4 persons	Total:	16,000		Occupancy:	4 persons
Usage rate:	50 gpcd				Usage rate:	50 gpcd				Usage rate:	50 gpcd
Daily use:	200 gpd				Daily use:	200 gpd				Daily use:	200 gpd

Burnet Rainwater Harvesting Model Summary				Burnet Rainwater Harvesting Model Summary				Burnet Rainwater Harvesting Model Summary			
Interior Use Only				Interior Use & Irrigation				Interior Use & Irrigation with Wastewater Reuse			
House with 4 person occupancy				House with 4 person occupancy, 2400 sq. ft. irrigated area				House with 4 person occupancy, 2400 sq. ft. irrigated area			
System Size & Water Use		Backup Water Required		System Size & Water Use		Backup Water Required		System Size & Water Use		Backup Water Required	
Roofprint:	4,500 sq. ft.	Year	Amount (gallons)	% of total usage	Roofprint:	4,500 sq. ft.	Year	Amount (gallons)	% of total usage	Roofprint:	4,500 sq. ft.
Cistern size:	40,000 gallons	2009	8,000	11	Cistern size:	40,000 gallons	2008	2,000	3	Cistern size:	40,000 gallons
Occupancy:	4 persons	2011	8,000	11	Occupancy:	4 persons	2009	8,000	11	Occupancy:	4 persons
Usage rate:	50 gpcd	Total:	16,000		Usage rate:	50 gpcd	2011	14,000	18	Usage rate:	50 gpcd
Daily use:	200 gpd				Daily use:	200 gpd	Total:	24,000		Daily use:	200 gpd
System Size & Water Use		Backup Water Required		System Size & Water Use		Backup Water Required		System Size & Water Use		Backup Water Required	
Roofprint:	4,500 sq. ft.	Year	Amount (gallons)	% of total usage	Roofprint:	4,500 sq. ft.	Year	Amount (gallons)	% of total usage	Roofprint:	4,500 sq. ft.
Cistern size:	40,000 gallons	2011	2,000	3	Cistern size:	40,000 gallons	2011	4,000	6	Cistern size:	40,000 gallons
Occupancy:	4 persons	Total:	2,000		Occupancy:	4 persons	Total:	4,000		Occupancy:	4 persons
Usage rate:	45 gpcd				Usage rate:	45 gpcd				Usage rate:	45 gpcd
Daily use:	180 gpd				Daily use:	180 gpd				Daily use:	180 gpd
System Size & Water Use		Backup Water Required		System Size & Water Use		Backup Water Required		System Size & Water Use		Backup Water Required	
Roofprint:	4,500 sq. ft.	Year	Amount (gallons)	% of total usage	Roofprint:	4,500 sq. ft.	Year	Amount (gallons)	% of total usage	Roofprint:	4,500 sq. ft.
Cistern size:	40,000 gallons	NONE required			Cistern size:	40,000 gallons	2011	NONE required		Cistern size:	40,000 gallons
Occupancy:	4 persons				Occupancy:	4 persons	Total:	4,000		Occupancy:	4 persons
Usage rate:	40 gpcd				Usage rate:	40 gpcd				Usage rate:	40 gpcd
Daily use:	160 gpd				Daily use:	160 gpd				Daily use:	160 gpd
System Size & Water Use		Backup Water Required		System Size & Water Use		Backup Water Required		System Size & Water Use		Backup Water Required	
Roofprint:	4,500 sq. ft.	Year	Amount (gallons)	% of total usage	Roofprint:	4,500 sq. ft.	Year	Amount (gallons)	% of total usage	Roofprint:	4,500 sq. ft.
Cistern size:	40,000 gallons	2009	4,000	6	Cistern size:	40,000 gallons	1994	2,000	3	Cistern size:	40,000 gallons
Curtailment vol:	6,000 gallons	2011	4,000	6	Curtailment vol:	6,000 gallons	2009	4,000	6	Curtailment vol:	6,000 gallons
Curtailment rate:	0.7 + irr.	Total:	8,000		Curtailment rate:	0.7 + irr.	2011	4,000	6	Curtailment rate:	0.7 + irr.
Occupancy:	4 persons				Occupancy:	4 persons	Total:	10,000		Occupancy:	4 persons
Usage rate:	50 gpcd				Usage rate:	50 gpcd				Usage rate:	50 gpcd
Daily use:	200 gpd				Daily use:	200 gpd				Daily use:	200 gpd

Burnet Rainwater Harvesting Model Summary Interior Use Only				Burnet Rainwater Harvesting Model Summary Interior Use & Irrigation				Burnet Rainwater Harvesting Model Summary Interior Use & Irrigation with Wastewater Reuse			
House with 4 person occupancy				House with 4 person occupancy, 2400 sq. ft. irrigated area				House with 4 person occupancy, 2400 sq. ft. irrigated area			
System Size & Water Use				System Size & Water Use				System Size & Water Use			
Roofprint:	5,500	sq. ft.		Roofprint:	5,500	sq. ft.		Roofprint:	5,500	sq. ft.	
Cistern size:	45,000	gallons		Cistern size:	45,000	gallons		Cistern size:	45,000	gallons	
Occupancy:	4	persons		Occupancy:	4	persons		Occupancy:	4	persons	
Usage rate:	60	gpcd		Usage rate:	45	gpcd		Usage rate:	45	gpcd	
Daily use:	240	gpd		Daily use:	180	gpd		Daily use:	180	gpd	
Backup Water Required				Backup Water Required				Backup Water Required			
Year	Amount (gallons)	% of total usage		Year	Amount (gallons)	% of total usage		Year	Amount (gallons)	% of total usage	
2008	2,000	2		2008	2,000	2		2008	2,000	2	
2009	8,000	9		2009	8,000	9		2009	8,000	9	
2011	10,000	11		2011	10,000	11		2011	12,000	14	
Total:	20,000			Total:	20,000			Total:	22,000		
System Size & Water Use				System Size & Water Use				System Size & Water Use			
Roofprint:	5,500	sq. ft.		Roofprint:	5,500	sq. ft.		Roofprint:	5,500	sq. ft.	
Cistern size:	45,000	gallons		Cistern size:	45,000	gallons		Cistern size:	45,000	gallons	
Curtailment vol:	7,200	gallons		Curtailment vol:	7,200	gallons		Curtailment vol:	7,200	gallons	
Curtailment rate:	0.7	+ irr.		Curtailment rate:	0.7	+ irr.		Curtailment rate:	0.7	+ irr.	
Occupancy:	4	persons		Occupancy:	4	persons		Occupancy:	4	persons	
Usage rate:	60	gpcd		Usage rate:	45	gpcd		Usage rate:	60	gpcd	
Daily use:	240	gpd		Daily use:	240	gpd		Daily use:	240	gpd	
Backup Water Required				Backup Water Required				Backup Water Required			
Year	Amount (gallons)	% of total usage		Year	Amount (gallons)	% of total usage		Year	Amount (gallons)	% of total usage	
2008	2,000	2		2008	2,000	2		2008	2,000	2	
2009	4,000	5		2009	4,000	5		2009	4,000	5	
2011	6,000	8		2011	6,000	8		2011	6,000	8	
Total:	12,000			Total:	12,000			Total:	12,000		
System Size & Water Use				System Size & Water Use				System Size & Water Use			
Roofprint:	5,500	sq. ft.		Roofprint:	5,500	sq. ft.		Roofprint:	5,500	sq. ft.	
Cistern size:	50,000	gallons		Cistern size:	50,000	gallons		Cistern size:	50,000	gallons	
Occupancy:	4	persons		Occupancy:	4	persons		Occupancy:	4	persons	
Usage rate:	60	gpcd		Usage rate:	60	gpcd		Usage rate:	60	gpcd	
Daily use:	240	gpd		Daily use:	240	gpd		Daily use:	240	gpd	
Backup Water Required				Backup Water Required				Backup Water Required			
Year	Amount (gallons)	% of total usage		Year	Amount (gallons)	% of total usage		Year	Amount (gallons)	% of total usage	
2009	6,000	7		2009	6,000	7		2009	6,000	7	
2011	6,000	7		2011	6,000	7		2011	8,000	9	
Total:	12,000			Total:	12,000			Total:	14,000		
System Size & Water Use				System Size & Water Use				System Size & Water Use			
Roofprint:	5,500	sq. ft.		Roofprint:	5,500	sq. ft.		Roofprint:	5,500	sq. ft.	
Cistern size:	50,000	gallons		Cistern size:	50,000	gallons		Cistern size:	50,000	gallons	
Curtailment vol:	7,200	gallons		Curtailment vol:	7,200	gallons		Curtailment vol:	7,200	gallons	
Curtailment rate:	0.7	+ irr.		Curtailment rate:	0.7	+ irr.		Curtailment rate:	0.7	+ irr.	
Occupancy:	4	persons		Occupancy:	4	persons		Occupancy:	4	persons	
Usage rate:	60	gpcd		Usage rate:	60	gpcd		Usage rate:	60	gpcd	
Daily use:	240	gpd		Daily use:	240	gpd		Daily use:	240	gpd	
Backup Water Required				Backup Water Required				Backup Water Required			
Year	Amount (gallons)	% of total usage		Year	Amount (gallons)	% of total usage		Year	Amount (gallons)	% of total usage	
2009	2,000	3		2009	2,000	3		2009	2,000	3	
2011	4,000	5		2011	4,000	5		2011	4,000	5	
Total:	6,000			Total:	6,000			Total:	6,000		

Requirements for house with 4 person occupancy, 2400 sq. ft. irrigated area with no wastewater irrigation											
System Size & Water Use				System Size & Water Use				System Size & Water Use			
Roofprint:	7,000	sq. ft.		Roofprint:	7,000	sq. ft.		Roofprint:	7,000	sq. ft.	
Cistern size:	50,000	gallons		Cistern size:	50,000	gallons		Cistern size:	50,000	gallons	
Occupancy:	4	persons		Occupancy:	4	persons		Occupancy:	4	persons	
Usage rate:	50	gpcd		Usage rate:	45	gpcd		Usage rate:	40	gpcd	
Daily use:	200	gpd		Daily use:	180	gpd		Daily use:	160	gpd	
Backup Water Required				Backup Water Required				Backup Water Required			
Year	Amount (gallons)	% of total usage		Year	Amount (gallons)	% of total usage		Year	Amount (gallons)	% of total usage	
2011	16,000	15		2011	10,000	10		2011	2,000	2	
Total:	16,000			Total:	10,000			Total:	2,000		
System Size & Water Use				System Size & Water Use				System Size & Water Use			
Roofprint:	7,000	sq. ft.		Roofprint:	7,000	sq. ft.		Roofprint:	7,000	sq. ft.	
Cistern size:	50,000	gallons		Cistern size:	50,000	gallons		Cistern size:	50,000	gallons	
Curtailment vol:	6,000	gallons		Curtailment vol:	6,000	gallons		Curtailment vol:	6,000	gallons	
Curtailment rate:	1.0	irr. only		Curtailment rate:	1.0	irr. only		Curtailment rate:	1.0	irr. only	
Occupancy:	4	persons		Occupancy:	4	persons		Occupancy:	4	persons	
Usage rate:	50	gpcd		Usage rate:	45	gpcd		Usage rate:	40	gpcd	
Daily use:	200	gpd		Daily use:	180	gpd		Daily use:	160	gpd	
Backup Water Required				Backup Water Required				Backup Water Required			
Year	Amount (gallons)	% of total usage		Year	Amount (gallons)	% of total usage		Year	Amount (gallons)	% of total usage	
2011	12,000	12		2011	4,000	4		2011	2,000	2	
Total:	12,000			Total:	4,000			Total:	2,000		

Appendix F – Dripping Springs Rainwater Harvesting Modeling Summary

Dripping Springs Rainwater Harvesting Model Summary Interior Use Only					Dripping Springs Rainwater Harvesting Model Summary Interior Use & Irrigation					Dripping Springs Rainwater Harvesting Model Summary Interior Use & Irrigation with Wastewater Reuse				
House with 2 person occupancy					House with 2 person occupancy, 1200 sq. ft. irrigated area					House with 2 person occupancy, 1200 sq. ft. irrigated area				
System Size & Water Use					System Size & Water Use					System Size & Water Use				
Roofprint:	2,500	sq. ft.			Roofprint:	2,500	sq. ft.			Roofprint:	2,500	sq. ft.		
Cistern size:	15,000	gallons			Cistern size:	15,000	gallons			Cistern size:	15,000	gallons		
Occupancy:	2	persons			Occupancy:	2	persons			Occupancy:	2	persons		
Usage rate:	50	gpcd			Usage rate:	50	gpcd			Usage rate:	50	gpcd		
Daily use:	100	gpd			Daily use:	100	gpd			Daily use:	100	gpd		
Backup Water Required					Backup Water Required					Backup Water Required				
	Year	Amount (gallons)	% of total usage			Year	Amount (gallons)	% of total usage			Year	Amount (gallons)	% of total usage	
	1996	2,000	5			1996	2,000	5			1996	4,000	11	
	2008	4,000	11			2008	4,000	11			2008	4,000	11	
	2009	4,000	11			2009	4,000	11			2009	6,000	16	
	2011	12,000	33			2011	12,000	33			2011	14,000	36	
	Total:	22,000				Total req. =	132,000	gallons			Total:	28,000		
System Size & Water Use					System Size & Water Use					System Size & Water Use				
Roofprint:	2,500	sq. ft.			Roofprint:	2,500	sq. ft.			Roofprint:	2,500	sq. ft.		
Cistern size:	15,000	gallons			Cistern size:	15,000	gallons			Cistern size:	15,000	gallons		
Occupancy:	2	persons			Occupancy:	2	persons			Occupancy:	2	persons		
Usage rate:	45	gpcd			Usage rate:	45	gpcd			Usage rate:	45	gpcd		
Daily use:	90	gpd			Daily use:	90	gpd			Daily use:	90	gpd		
Backup Water Required					Backup Water Required					Backup Water Required				
	Year	Amount (gallons)	% of total usage			Year	Amount (gallons)	% of total usage			Year	Amount (gallons)	% of total usage	
	2009	2,000	6			2009	2,000	6			2009	4,000	12	
	2011	8,000	24			2011	8,000	24			2011	10,000	28	
	Total:	10,000				Total req. =	92,000	gallons			Total:	14,000		
System Size & Water Use					System Size & Water Use					System Size & Water Use				
Roofprint:	2,500	sq. ft.			Roofprint:	2,500	sq. ft.			Roofprint:	2,500	sq. ft.		
Cistern size:	15,000	gallons			Cistern size:	15,000	gallons			Cistern size:	15,000	gallons		
Occupancy:	2	persons			Occupancy:	2	persons			Occupancy:	2	persons		
Usage rate:	40	gpcd			Usage rate:	40	gpcd			Usage rate:	40	gpcd		
Daily use:	80	gpd			Daily use:	80	gpd			Daily use:	80	gpd		
Backup Water Required					Backup Water Required					Backup Water Required				
	Year	Amount (gallons)	% of total usage			Year	Amount (gallons)	% of total usage			Year	Amount (gallons)	% of total usage	
	2011	4,000	14			2011	4,000	14			2011	8,000	24	
	Total:	4,000				Total req. =	64,000	gallons			Total:	8,000		
System Size & Water Use					System Size & Water Use					System Size & Water Use				
Roofprint:	2,500	sq. ft.			Roofprint:	2,500	sq. ft.			Roofprint:	2,500	sq. ft.		
Cistern size:	15,000	gallons			Cistern size:	15,000	gallons			Cistern size:	15,000	gallons		
Curtailment vol.:	3,000	gallons			Curtailment vol.:	3,000	gallons			Curtailment vol.:	3,000	gallons		
Curtailment rate:	0.7	+ irr.			Curtailment rate:	0.7	+ irr.			Curtailment rate:	0.7	+ irr.		
Occupancy:	2	persons			Occupancy:	2	persons			Occupancy:	2	persons		
Usage rate:	50	gpcd			Usage rate:	50	gpcd			Usage rate:	50	gpcd		
Daily use:	100	gpd			Daily use:	100	gpd			Daily use:	100	gpd		
Backup Water Required					Backup Water Required					Backup Water Required				
	Year	Amount (gallons)	% of total usage			Year	Amount (gallons)	% of total usage			Year	Amount (gallons)	% of total usage	
	1996	2,000	6			1996	2,000	6			1999	2,000	6	
	2008	4,000	11			2008	4,000	11			2008	4,000	11	
	2009	2,000	6			2009	2,000	6			2009	4,000	11	
	2011	8,000	25			2011	8,000	25			2011	8,000	25	
	Total:	14,000				Total req. =	72,000	gallons			Total:	18,000		

Dripping Springs Rainwater Harvesting Model Summary Interior Use Only				Dripping Springs Rainwater Harvesting Model Summary Interior Use & Irrigation				Dripping Springs Rainwater Harvesting Model Summary Interior Use & Irrigation with Wastewater Reuse			
House with 2.5 person occupancy				House with 2.5 person occupancy, 1500 sq. ft. irrigated area				House with 2.5 person occupancy, 1500 sq. ft. irrigated area			
System Size & Water Use		Backup Water Required		System Size & Water Use		Backup Water Required		System Size & Water Use		Backup Water Required	
Roofprint:	3,500 sq. ft.	Year	Amount (gallons)	% of total usage	Roofprint:	3,500 sq. ft.	Year	Amount (gallons)	% of total usage	Roofprint:	3,500 sq. ft.
Cistern size:	20,000 gallons	2009	2,000	4	Cistern size:	20,000 gallons	2011	4,000	10	Cistern size:	20,000 gallons
Occupancy:	2.5 persons	2011	10,000	22	Occupancy:	2.5 persons	Total:	2,000	5	Occupancy:	2.5 persons
Usage rate:	50 gpcd				Usage rate:	40 gpcd				Usage rate:	50 gpcd
Daily use:	125 gpd				Daily use:	112.5 gpd				Daily use:	125 gpd
System Size & Water Use		Backup Water Required		System Size & Water Use		Backup Water Required		System Size & Water Use		Backup Water Required	
Roofprint:	3,500 sq. ft.	Year	Amount (gallons)	% of total usage	Roofprint:	3,500 sq. ft.	Year	Amount (gallons)	% of total usage	Roofprint:	3,500 sq. ft.
Cistern size:	20,000 gallons	2011	4,000	10	Cistern size:	20,000 gallons	2011	8,000	18	Cistern size:	20,000 gallons
Occupancy:	2.5 persons	Total:	4,000		Occupancy:	2.5 persons	Total:	8,000		Occupancy:	2.5 persons
Usage rate:	45 gpcd				Usage rate:	45 gpcd				Usage rate:	45 gpcd
Daily use:	112.5 gpd				Daily use:	112.5 gpd				Daily use:	112.5 gpd
System Size & Water Use		Backup Water Required		System Size & Water Use		Backup Water Required		System Size & Water Use		Backup Water Required	
Roofprint:	3,500 sq. ft.	Year	Amount (gallons)	% of total usage	Roofprint:	3,500 sq. ft.	Year	Amount (gallons)	% of total usage	Roofprint:	3,500 sq. ft.
Cistern size:	20,000 gallons	2011	2,000	5	Cistern size:	20,000 gallons	2011	4,000	10	Cistern size:	20,000 gallons
Occupancy:	2.5 persons	Total:	2,000		Occupancy:	2.5 persons	Total:	4,000		Occupancy:	2.5 persons
Usage rate:	40 gpcd				Usage rate:	40 gpcd				Usage rate:	40 gpcd
Daily use:	100 gpd				Daily use:	100 gpd				Daily use:	100 gpd
System Size & Water Use		Backup Water Required		System Size & Water Use		Backup Water Required		System Size & Water Use		Backup Water Required	
Roofprint:	3,500 sq. ft.	Year	Amount (gallons)	% of total usage	Roofprint:	3,500 sq. ft.	Year	Amount (gallons)	% of total usage	Roofprint:	3,500 sq. ft.
Cistern size:	20,000 gallons	2011	6,000	15	Cistern size:	20,000 gallons	2011	6,000	15	Cistern size:	20,000 gallons
Curtailment vol:	3,750 gallons	Total:	6,000		Curtailment vol:	3,750 gallons	Total:	6,000		Curtailment vol:	3,750 gallons
Curtailment rate:	0.7 + irr.				Curtailment rate:	0.7 + irr.				Curtailment rate:	0.7 + irr.
Occupancy:	2.5 persons				Occupancy:	2.5 persons				Occupancy:	2.5 persons
Usage rate:	50 gpcd				Usage rate:	50 gpcd				Usage rate:	50 gpcd
Daily use:	125 gpd				Daily use:	125 gpd				Daily use:	125 gpd

Dripping Springs Rainwater Harvesting Model Summary Interior Use Only				Dripping Springs Rainwater Harvesting Model Summary Interior Use & Irrigation				Dripping Springs Rainwater Harvesting Model Summary Interior Use & Irrigation with Wastewater Reuse			
House with 3 person occupancy				House with 3 person occupancy, 1800 sq. ft. irrigated area				House with 3 person occupancy, 1800 sq. ft. irrigated area			
System Size & Water Use		Backup Water Required		System Size & Water Use		Backup Water Required		System Size & Water Use		Backup Water Required	
Roofprint:	4,000 sq. ft.	Year	Amount (gallons)	% of total usage	Roofprint:	4,000 sq. ft.	Year	Amount (gallons)	% of total usage	Roofprint:	4,000 sq. ft.
Cistern size:	20,000 gallons	1996	2,000	4	Cistern size:	20,000 gallons	2009	2,000	4	Cistern size:	20,000 gallons
Occupancy:	3 persons	2009	6,000	11	Occupancy:	3 persons	2011	16,000	29	Occupancy:	3 persons
Usage rate:	50 gpcd	2011	16,000	29	Usage rate:	50 gpcd	Total:	26,000		Usage rate:	50 gpcd
Daily use:	150 gpd				Daily use:	150 gpd				Daily use:	150 gpd
System Size & Water Use		Backup Water Required		System Size & Water Use		Backup Water Required		System Size & Water Use		Backup Water Required	
Roofprint:	4,000 sq. ft.	Year	Amount (gallons)	% of total usage	Roofprint:	4,000 sq. ft.	Year	Amount (gallons)	% of total usage	Roofprint:	4,000 sq. ft.
Cistern size:	20,000 gallons	2011	10,000	20	Cistern size:	20,000 gallons	2011	10,000	20	Cistern size:	20,000 gallons
Occupancy:	3 persons	Total:	10,000		Occupancy:	3 persons	Total:	10,000		Occupancy:	3 persons
Usage rate:	45 gpcd				Usage rate:	45 gpcd				Usage rate:	45 gpcd
Daily use:	135 gpd				Daily use:	135 gpd				Daily use:	135 gpd
System Size & Water Use		Backup Water Required		System Size & Water Use		Backup Water Required		System Size & Water Use		Backup Water Required	
Roofprint:	4,000 sq. ft.	Year	Amount (gallons)	% of total usage	Roofprint:	4,000 sq. ft.	Year	Amount (gallons)	% of total usage	Roofprint:	4,000 sq. ft.
Cistern size:	20,000 gallons	2011	4,000	9	Cistern size:	20,000 gallons	2011	4,000	9	Cistern size:	20,000 gallons
Occupancy:	3 persons	Total:	4,000		Occupancy:	3 persons	Total:	4,000		Occupancy:	3 persons
Usage rate:	40 gpcd				Usage rate:	40 gpcd				Usage rate:	40 gpcd
Daily use:	120 gpd				Daily use:	120 gpd				Daily use:	120 gpd
System Size & Water Use		Backup Water Required		System Size & Water Use		Backup Water Required		System Size & Water Use		Backup Water Required	
Roofprint:	4,000 sq. ft.	Year	Amount (gallons)	% of total usage	Roofprint:	4,000 sq. ft.	Year	Amount (gallons)	% of total usage	Roofprint:	4,000 sq. ft.
Cistern size:	20,000 gallons	2008	2,000	4	Cistern size:	20,000 gallons	2008	2,000	4	Cistern size:	20,000 gallons
Curtailment vol:	4,500 gallons	2009	2,000	4	Curtailment vol:	4,500 gallons	2009	2,000	4	Curtailment vol:	4,500 gallons
Curtailment rate:	0.7 + irr.	2011	8,000	18	Curtailment rate:	0.7 + irr.	2011	8,000	18	Curtailment rate:	0.7 + irr.
Occupancy:	3 persons	Total:	12,000		Occupancy:	3 persons	Total:	12,000		Occupancy:	3 persons
Usage rate:	50 gpcd				Usage rate:	50 gpcd				Usage rate:	50 gpcd
Daily use:	150 gpd				Daily use:	150 gpd				Daily use:	150 gpd

Dripping Springs Rainwater Harvesting Model Summary
Interior Use Only

House with 3 person occupancy			
System Size & Water Use			
Year	Amount (gallons)	% of total usage	
2009	4,000	7	
2011	12,000	22	
Total: 16,000			
Backup Water Required			
System Size & Water Use			
Year	Amount (gallons)	% of total usage	
2011	6,000	12	
Total: 6,000			
Backup Water Required			
System Size & Water Use			
Year	Amount (gallons)	% of total usage	
2011	2,000	5	
Total: 2,000			
Backup Water Required			
System Size & Water Use			
Year	Amount (gallons)	% of total usage	
2009	2,000	4	
2011	6,000	13	
Total: 8,000			

Dripping Springs Rainwater Harvesting Model Summary
Interior Use & Irrigation

House with 3 person occupancy, 1800 sq. ft. irrigated area			
System Size & Water Use			
Year	Amount (gallons)	% of total usage	
2009	4,000	7	
2011	12,000	22	
Total: 16,000			
Backup Water Required			
System Size & Water Use			
Year	Amount (gallons)	% of total usage	
2011	6,000	12	
Total: 6,000			
Backup Water Required			
System Size & Water Use			
Year	Amount (gallons)	% of total usage	
2011	2,000	5	
Total: 2,000			
Backup Water Required			
System Size & Water Use			
Year	Amount (gallons)	% of total usage	
2009	2,000	4	
2011	6,000	13	
Total: 8,000			

Dripping Springs Rainwater Harvesting Model Summary
Interior Use & Irrigation with Wastewater Reuse

House with 3 person occupancy, 1800 sq. ft. irrigated area			
System Size & Water Use			
Year	Amount (gallons)	% of total usage	
2009	4,000	7	
2011	14,000	24	
Total: 20,000			
Backup Water Required			
System Size & Water Use			
Year	Amount (gallons)	% of total usage	
2011	10,000	19	
Total: 10,000			
Backup Water Required			
System Size & Water Use			
Year	Amount (gallons)	% of total usage	
2011	6,000	12	
Total: 6,000			
Backup Water Required			
System Size & Water Use			
Year	Amount (gallons)	% of total usage	
2009	2,000	4	
2011	6,000	12	
Total: 8,000			

Dripping Springs Rainwater Harvesting Model Summary
Interior Use Only

House with 4 person occupancy			
System Size & Water Use			
Year	Amount (gallons)	% of total usage	
1996	2,000	3	
2008	4,000	5	
2009	14,000	19	
2011	18,000	25	
Total: 38,000			
Backup Water Required			
System Size & Water Use			
Year	Amount (gallons)	% of total usage	
2009	4,000	6	
2011	10,000	15	
Total: 14,000			
Backup Water Required			
System Size & Water Use			
Year	Amount (gallons)	% of total usage	
2011	2,000	3	
Total: 2,000			
Backup Water Required			
System Size & Water Use			
Year	Amount (gallons)	% of total usage	
2008	2,000	3	
2009	4,000	7	
2011	10,000	16	
Total: 16,000			

Dripping Springs Rainwater Harvesting Model Summary
Interior Use & Irrigation

House with 4 person occupancy, 2400 sq. ft. irrigated area			
System Size & Water Use			
Year	Amount (gallons)	% of total usage	
1996	2,000	3	
2008	4,000	5	
2009	14,000	19	
2011	18,000	25	
Total: 38,000			
Backup Water Required			
System Size & Water Use			
Year	Amount (gallons)	% of total usage	
2009	4,000	6	
2011	10,000	15	
Total: 14,000			
Backup Water Required			
System Size & Water Use			
Year	Amount (gallons)	% of total usage	
2011	2,000	3	
Total: 2,000			
Backup Water Required			
System Size & Water Use			
Year	Amount (gallons)	% of total usage	
2008	2,000	3	
2009	4,000	7	
2011	10,000	16	
Total: 16,000			

Dripping Springs Rainwater Harvesting Model Summary
Interior Use & Irrigation with Wastewater Reuse

House with 4 person occupancy, 2400 sq. ft. irrigated area			
System Size & Water Use			
Year	Amount (gallons)	% of total usage	
1996	2,000	3	
2008	6,000	8	
2009	14,000	19	
2011	22,000	29	
Total: 44,000			
Backup Water Required			
System Size & Water Use			
Year	Amount (gallons)	% of total usage	
2009	8,000	12	
2011	16,000	22	
Total: 24,000			
Backup Water Required			
System Size & Water Use			
Year	Amount (gallons)	% of total usage	
2011	10,000	15	
Total: 10,000			
Backup Water Required			
System Size & Water Use			
Year	Amount (gallons)	% of total usage	
2008	2,000	3	
2009	4,000	7	
2011	10,000	16	
Total: 16,000			

Dripping Springs Rainwater Harvesting Model Summary
Interior Use Only

House with 4 person occupancy			
Backup Water Required			
System Size & Water Use	Year	Amount (gallons)	% of total usage
Roofprint: 4,500 sq. ft.			
Cistern size: 40,000 gallons	2009	12,000	16
	2011	14,000	19
Occupancy: 4 persons	Total:	26,000	
Usage rate: 50 gpcd			
Daily use: 200 gpd			
Backup Water Required			
System Size & Water Use	Year	Amount (gallons)	% of total usage
Roofprint: 4,500 sq. ft.			
Cistern size: 40,000 gallons	2011	6,000	9
Occupancy: 4 persons	Total:	6,000	
Usage rate: 45 gpcd			
Daily use: 180 gpd			
Backup Water Required			
System Size & Water Use	Year	Amount (gallons)	% of total usage
Roofprint: 4,500 sq. ft.			
Cistern size: 40,000 gallons	NONE required		
Occupancy: 4 persons			
Usage rate: 45 gpcd			
Daily use: 160 gpd			
Backup Water Required			
System Size & Water Use	Year	Amount (gallons)	% of total usage
Roofprint: 4,500 sq. ft.			
Cistern size: 40,000 gallons	2009	4,000	6
Curtailment vol: 6,000 gallons	2011	8,000	12
Curtailment rate: 0.7 + irr.	Total:	12,000	
Occupancy: 4 persons			
Usage rate: 50 gpcd			
Daily use: 200 gpd			

Dripping Springs Rainwater Harvesting Model Summary
Interior Use & Irrigation

House with 4 person occupancy, 2400 sq. ft. irrigated area			
Backup Water Required			
System Size & Water Use	Year	Amount (gallons)	% of total usage
Roofprint: 4,500 sq. ft.			
Cistern size: 40,000 gallons			
Backup water required in 12 years			
Max yr. = 52,000 in 2011			
2nd most = 36,000 in 2 years			
Total req. = 232,000 gallons			
Occupancy: 4 persons			
Usage rate: 50 gpcd			
Daily use: 200 gpd			
Backup Water Required			
System Size & Water Use	Year	Amount (gallons)	% of total usage
Roofprint: 4,500 sq. ft.			
Cistern size: 40,000 gallons			
Backup water required in 10 years			
Max yr. = 44,000 in 2011			
2nd most = 30,000 in 2009			
Total req. = 144,000 gallons			
Occupancy: 4 persons			
Usage rate: 45 gpcd			
Daily use: 180 gpd			
Backup Water Required			
System Size & Water Use	Year	Amount (gallons)	% of total usage
Roofprint: 4,500 sq. ft.			
Cistern size: 40,000 gallons			
Backup water required in 4 years			
Max yr. = 38,000 in 2011			
2nd most = 26,000 in 2009			
Total req. = 94,000 gallons			
Occupancy: 4 persons			
Usage rate: 40 gpcd			
Daily use: 160 gpd			
Backup Water Required			
System Size & Water Use	Year	Amount (gallons)	% of total usage
Roofprint: 4,500 sq. ft.			
Cistern size: 40,000 gallons			
Backup water required in 12 years			
Max yr. = 12,000 in 2 years			
2nd most = 10,000 in 2 years			
Total req. = 70,000 gallons			
Occupancy: 4 persons			
Usage rate: 50 gpcd			
Daily use: 200 gpd			

Dripping Springs Rainwater Harvesting Model Summary
Interior Use & Irrigation with Wastewater Reuse

House with 4 person occupancy, 2400 sq. ft. irrigated area			
Backup Water Required			
System Size & Water Use	Year	Amount (gallons)	% of total usage
Roofprint: 4,500 sq. ft.			
Cistern size: 40,000 gallons	2008	2,000	3
	2009	14,000	19
	2011	18,000	33
Occupancy: 4 persons	Total:	34,000	
Usage rate: 50 gpcd			
Daily use: 200 gpd			
Backup Water Required			
System Size & Water Use	Year	Amount (gallons)	% of total usage
Roofprint: 4,500 sq. ft.			
Cistern size: 40,000 gallons	2009	4,000	6
	2011	10,000	14
Occupancy: 4 persons	Total:	14,000	
Usage rate: 45 gpcd			
Daily use: 180 gpd			
Backup Water Required			
System Size & Water Use	Year	Amount (gallons)	% of total usage
Roofprint: 4,500 sq. ft.			
Cistern size: 40,000 gallons	2011	6,000	9
Occupancy: 4 persons	Total:	6,000	
Usage rate: 40 gpcd			
Daily use: 160 gpd			
Backup Water Required			
System Size & Water Use	Year	Amount (gallons)	% of total usage
Roofprint: 4,500 sq. ft.			
Cistern size: 40,000 gallons	2008	2,000	3
Curtailment vol: 6,000 gallons	2009	6,000	10
Curtailment rate: 0.7 + irr.	2011	10,000	15
Occupancy: 4 persons	Total:	18,000	
Usage rate: 50 gpcd			
Daily use: 200 gpd			

Dripping Springs Rainwater Harvesting Model Summary
Interior Use Only

House with 4 person occupancy			
Backup Water Required			
System Size & Water Use	Year	Amount (gallons)	% of total usage
Roofprint: 5,000 sq. ft.			
Cistern size: 40,000 gallons	2009	4,000	5
	2011	10,000	14
Occupancy: 4 persons	Total:	14,000	
Usage rate: 50 gpcd			
Daily use: 200 gpd			
Backup Water Required			
System Size & Water Use	Year	Amount (gallons)	% of total usage
Roofprint: 5,000 sq. ft.			
Cistern size: 40,000 gallons	2011	2,000	3
Occupancy: 4 persons	Total:	2,000	
Usage rate: 45 gpcd			
Daily use: 180 gpd			
Backup Water Required			
System Size & Water Use	Year	Amount (gallons)	% of total usage
Roofprint: 5,000 sq. ft.			
Cistern size: 40,000 gallons	NONE required		
Occupancy: 4 persons			
Usage rate: 40 gpcd			
Daily use: 160 gpd			
Backup Water Required			
System Size & Water Use	Year	Amount (gallons)	% of total usage
Roofprint: 5,000 sq. ft.			
Cistern size: 40,000 gallons	2011	6,000	9
Curtailment vol: 6,000 gallons	Total:	6,000	
Curtailment rate: 0.7 + irr.			
Occupancy: 4 persons			
Usage rate: 50 gpcd			
Daily use: 200 gpd			

Dripping Springs Rainwater Harvesting Model Summary
Interior Use & Irrigation

House with 4 person occupancy, 2400 sq. ft. irrigated area			
Backup Water Required			
System Size & Water Use	Year	Amount (gallons)	% of total usage
Roofprint: 5,000 sq. ft.			
Cistern size: 40,000 gallons			
Backup water required in 9 years			
Max yr. = 50,000 in 2011			
2nd most = 32,000 in 2009			
Total req. = 156,000 gallons			
Occupancy: 4 persons			
Usage rate: 50 gpcd			
Daily use: 200 gpd			
Backup Water Required			
System Size & Water Use	Year	Amount (gallons)	% of total usage
Roofprint: 5,000 sq. ft.			
Cistern size: 40,000 gallons			
Backup water required in 4 years			
Max yr. = 42,000 in 2011			
2nd most = 28,000 in 2009			
Total req. = 104,000 gallons			
Occupancy: 4 persons			
Usage rate: 45 gpcd			
Daily use: 180 gpd			
Backup Water Required			
System Size & Water Use	Year	Amount (gallons)	% of total usage
Roofprint: 5,000 sq. ft.			
Cistern size: 40,000 gallons			
Backup water required in 7 years			
Max yr. = 14,000 in 2011			
2nd most = 6,000 in 3 years			
Total req. = 40,000 gallons			
Occupancy: 4 persons			
Usage rate: 50 gpcd			
Daily use: 200 gpd			

Dripping Springs Rainwater Harvesting Model Summary
Interior Use & Irrigation with Wastewater Reuse

House with 4 person occupancy, 2400 sq. ft. irrigated area			
Backup Water Required			
System Size & Water Use	Year	Amount (gallons)	% of total usage
Roofprint: 5,000 sq. ft.			
Cistern size: 40,000 gallons	2009	6,000	8
	2011	14,000	18
Occupancy: 4 persons	Total:	20,000	
Usage rate: 50 gpcd			
Daily use: 200 gpd			
Backup Water Required			
System Size & Water Use	Year	Amount (gallons)	% of total usage
Roofprint: 5,000 sq. ft.			
Cistern size: 40,000 gallons	2011	8,000	11
Occupancy: 4 persons	Total:	8,000	
Usage rate: 45 gpcd			
Daily use: 180 gpd			
Backup Water Required			
System Size & Water Use	Year	Amount (gallons)	% of total usage
Roofprint: 5,000 sq. ft.			
Cistern size: 40,000 gallons	2011	2,000	3
Occupancy: 4 persons	Total:	2,000	
Usage rate: 40 gpcd			
Daily use: 160 gpd			
Backup Water Required			
System Size & Water Use	Year	Amount (gallons)	% of total usage
Roofprint: 5,000 sq. ft.			
Cistern size: 40,000 gallons	2011	8,000	12
Curtailment vol: 6,000 gallons	Total:	8,000	
Curtailment rate: 0.7 + irr.			
Occupancy: 4 persons			
Usage rate: 50 gpcd			
Daily use: 200 gpd			

Dripping Springs Rainwater Harvesting Model Summary Interior Use Only				Dripping Springs Rainwater Harvesting Model Summary Interior Use & Irrigation				Dripping Springs Rainwater Harvesting Model Summary Interior Use & Irrigation with Wastewater Reuse			
House with 4 person occupancy				House with 4 person occupancy, 2400 sq. ft. irrigated area				House with 4 person occupancy, 2400 sq. ft. irrigated area			
System Size & Water Use				System Size & Water Use				System Size & Water Use			
Roofprint:	5,500	sq. ft.		Roofprint:	5,500	sq. ft.		Roofprint:	5,500	sq. ft.	
Cistern size:	45,000	gallons		Cistern size:	45,000	gallons		Cistern size:	45,000	gallons	
Occupancy:	4	persons		Occupancy:	4	persons		Occupancy:	4	persons	
Usage rate:	60	gpcd		Usage rate:	45	gpcd		Usage rate:	45	gpcd	
Daily use:	240	gpd		Daily use:	180	gpd		Daily use:	180	gpd	
Backup Water Required				Backup Water Required				Backup Water Required			
Year	Amount (gallons)	% of total usage		Year	Amount (gallons)	% of total usage		Year	Amount (gallons)	% of total usage	
2008	2,000	2		2008	2,000	2		2008	2,000	2	
2009	14,000	16		2009	14,000	16		2009	14,000	16	
2011	18,000	21		2011	18,000	21		2011	18,000	21	
Total:	34,000			Total:	34,000			Total:	34,000		
System Size & Water Use				System Size & Water Use				System Size & Water Use			
Roofprint:	5,500	sq. ft.		Roofprint:	5,500	sq. ft.		Roofprint:	5,500	sq. ft.	
Cistern size:	45,000	gallons		Cistern size:	45,000	gallons		Cistern size:	45,000	gallons	
Occupancy:	4	persons		Occupancy:	4	persons		Occupancy:	4	persons	
Usage rate:	60	gpcd		Usage rate:	45	gpcd		Usage rate:	45	gpcd	
Daily use:	240	gpd		Daily use:	180	gpd		Daily use:	180	gpd	
Backup Water Required				Backup Water Required				Backup Water Required			
Year	Amount (gallons)	% of total usage		Year	Amount (gallons)	% of total usage		Year	Amount (gallons)	% of total usage	
2008	2,000	2		2008	2,000	2		2008	2,000	2	
2009	14,000	13		2009	14,000	13		2009	14,000	13	
2011	10,000			2011	10,000			2011	10,000		
Total:	16,000			Total:	16,000			Total:	14,000		
System Size & Water Use				System Size & Water Use				System Size & Water Use			
Roofprint:	6,000	sq. ft.		Roofprint:	6,000	sq. ft.		Roofprint:	6,000	sq. ft.	
Cistern size:	50,000	gallons		Cistern size:	50,000	gallons		Cistern size:	50,000	gallons	
Occupancy:	4	persons		Occupancy:	4	persons		Occupancy:	4	persons	
Usage rate:	60	gpcd		Usage rate:	60	gpcd		Usage rate:	60	gpcd	
Daily use:	240	gpd		Daily use:	240	gpd		Daily use:	240	gpd	
Backup Water Required				Backup Water Required				Backup Water Required			
Year	Amount (gallons)	% of total usage		Year	Amount (gallons)	% of total usage		Year	Amount (gallons)	% of total usage	
2009	2,000	2		2009	2,000	2		2009	2,000	2	
2011	10,000	11		2011	10,000	11		2011	10,000	11	
Total:	12,000			Total:	12,000			Total:	12,000		
System Size & Water Use				System Size & Water Use				System Size & Water Use			
Roofprint:	6,000	sq. ft.		Roofprint:	6,000	sq. ft.		Roofprint:	6,000	sq. ft.	
Cistern size:	50,000	gallons		Cistern size:	50,000	gallons		Cistern size:	50,000	gallons	
Occupancy:	4	persons		Occupancy:	4	persons		Occupancy:	4	persons	
Usage rate:	60	gpcd		Usage rate:	60	gpcd		Usage rate:	60	gpcd	
Daily use:	240	gpd		Daily use:	240	gpd		Daily use:	240	gpd	
Backup Water Required				Backup Water Required				Backup Water Required			
Year	Amount (gallons)	% of total usage		Year	Amount (gallons)	% of total usage		Year	Amount (gallons)	% of total usage	
2011	4,000	5		2011	4,000	5		2011	4,000	5	
Total:	4,000			Total:	4,000			Total:	4,000		

Requirements for house with 4 person occupancy, 2,400 sq. ft. irrigated area with no wastewater irrigation															
System Size & Water Use				System Size & Water Use				System Size & Water Use				System Size & Water Use			
Roofprint:	7,500	sq. ft.		Roofprint:	7,500	sq. ft.		Roofprint:	7,500	sq. ft.		Roofprint:	7,500	sq. ft.	
Cistern size:	50,000	gallons		Cistern size:	50,000	gallons		Cistern size:	50,000	gallons		Cistern size:	50,000	gallons	
Occupancy:	4	persons		Occupancy:	4	persons		Occupancy:	4	persons		Occupancy:	4	persons	
Usage rate:	50	gpcd		Usage rate:	45	gpcd		Usage rate:	40	gpcd		Usage rate:	40	gpcd	
Daily use:	200	gpd		Daily use:	180	gpd		Daily use:	160	gpd		Daily use:	160	gpd	
Backup Water Required				Backup Water Required				Backup Water Required				Backup Water Required			
Year	Amount (gallons)	% of total usage		Year	Amount (gallons)	% of total usage		Year	Amount (gallons)	% of total usage		Year	Amount (gallons)	% of total usage	
2009	2,000	2		2009	2,000	2		2009	2,000	2		2009	2,000	2	
2011	24,000	22		2011	18,000	18		2011	18,000	18		2011	10,000	11	
Total:	26,000			Total:	18,000			Total:	18,000			Total:	10,000		
System Size & Water Use				System Size & Water Use				System Size & Water Use				System Size & Water Use			
Roofprint:	7,500	sq. ft.		Roofprint:	7,500	sq. ft.		Roofprint:	7,500	sq. ft.		Roofprint:	7,500	sq. ft.	
Cistern size:	50,000	gallons		Cistern size:	50,000	gallons		Cistern size:	50,000	gallons		Cistern size:	50,000	gallons	
Occupancy:	4	persons		Occupancy:	4	persons		Occupancy:	4	persons		Occupancy:	4	persons	
Usage rate:	50	gpcd		Usage rate:	45	gpcd		Usage rate:	40	gpcd		Usage rate:	40	gpcd	
Daily use:	200	gpd		Daily use:	180	gpd		Daily use:	160	gpd		Daily use:	160	gpd	
Backup Water Required				Backup Water Required				Backup Water Required				Backup Water Required			
Year	Amount (gallons)	% of total usage		Year	Amount (gallons)	% of total usage		Year	Amount (gallons)	% of total usage		Year	Amount (gallons)	% of total usage	
2009	2,000	2		2009	2,000	2		2009	2,000	2		2009	2,000	2	
2011	12,000	13		2011	6,000	7		2011	6,000	7		2011	6,000	7	
Total:	14,000			Total:	6,000			Total:	6,000			Total:	6,000		

Appendix G – Fredericksburg Rainwater Harvesting Modeling Summary

Fredericksburg Rainwater Harvesting Model Summary				Fredericksburg Rainwater Harvesting Model Summary				Fredericksburg Rainwater Harvesting Model Summary				
Interior Use Only				Interior Use & Irrigation				Interior Use & Irrigation with Wastewater Reuse				
House with 2 person occupancy				House with 2 person occupancy, 1200 sq. ft. irrigated area				House with 2 person occupancy, 1200 sq. ft. irrigated area				
System Size & Water Use		Backup Water Required		System Size & Water Use		Backup Water Required		System Size & Water Use		Backup Water Required		
Roofprint:	2,500 sq. ft.	Year	Amount (gallons)	% of total usage	Roofprint:	2,500 sq. ft.	Year	Amount (gallons)	% of total usage	Roofprint:	2,500 sq. ft.	
Cistern size:	15,000 gallons	1998	2,000	5	Cistern size:	15,000 gallons	2009	4,000	12	Cistern size:	15,000 gallons	
Occupancy:	2 persons	2000	4,000	11	Occupancy:	2 persons	2011	12,000	27	Occupancy:	2 persons	
Usage rate:	50 gpcd	2008	4,000	11	Usage rate:	45 gpcd	Total:	16,000		Usage rate:	50 gpcd	
Daily use:	100 gpd	2009	4,000	11	Daily use:	90 gpd				Daily use:	100 gpd	
		2011	16,000	46								
		Total:	30,000								Total:	34,000
System Size & Water Use		Backup Water Required		System Size & Water Use		Backup Water Required		System Size & Water Use		Backup Water Required		
Roofprint:	2,500 sq. ft.	Year	Amount (gallons)	% of total usage	Roofprint:	2,500 sq. ft.	Year	Amount (gallons)	% of total usage	Roofprint:	2,500 sq. ft.	
Cistern size:	15,000 gallons	2009	4,000	12	Cistern size:	15,000 gallons	2000	4,000	11	Cistern size:	15,000 gallons	
Occupancy:	2 persons	2011	12,000	27	Occupancy:	2 persons	2008	4,000	11	Occupancy:	2 persons	
Usage rate:	45 gpcd	Total:	16,000		Usage rate:	45 gpcd	2009	4,000	12	Usage rate:	45 gpcd	
Daily use:	90 gpd				Daily use:	90 gpd	2011	16,000	46	Daily use:	90 gpd	
											Total:	26,000
System Size & Water Use		Backup Water Required		System Size & Water Use		Backup Water Required		System Size & Water Use		Backup Water Required		
Roofprint:	2,500 sq. ft.	Year	Amount (gallons)	% of total usage	Roofprint:	2,500 sq. ft.	Year	Amount (gallons)	% of total usage	Roofprint:	2,500 sq. ft.	
Cistern size:	15,000 gallons	2011	8,000	27	Cistern size:	15,000 gallons	2000	4,000	11	Cistern size:	15,000 gallons	
Occupancy:	2 persons	Total:	8,000		Occupancy:	2 persons	2008	4,000	11	Occupancy:	2 persons	
Usage rate:	40 gpcd				Usage rate:	40 gpcd	2009	4,000	12	Usage rate:	40 gpcd	
Daily use:	80 gpd				Daily use:	80 gpd	2011	12,000	36	Daily use:	80 gpd	
											Total:	16,000
System Size & Water Use		Backup Water Required		System Size & Water Use		Backup Water Required		System Size & Water Use		Backup Water Required		
Roofprint:	2,500 sq. ft.	Year	Amount (gallons)	% of total usage	Roofprint:	2,500 sq. ft.	Year	Amount (gallons)	% of total usage	Roofprint:	2,500 sq. ft.	
Cistern size:	15,000 gallons	2000	4,000	11	Cistern size:	15,000 gallons	2000	4,000	11	Cistern size:	15,000 gallons	
Curtailment vol:	3,000 gallons	2008	4,000	11	Curtailment vol:	3,000 gallons	2008	4,000	11	Curtailment vol:	3,000 gallons	
Curtailment rate:	0.7 + irr.	2009	4,000	12	Curtailment rate:	0.7 + irr.	2009	4,000	11	Curtailment rate:	0.7 + irr.	
Occupancy:	2 persons	2011	14,000	43	Occupancy:	2 persons	2009	4,000	11	Occupancy:	2 persons	
Usage rate:	50 gpcd	Total:	22,000		Usage rate:	50 gpcd	2011	14,000	42	Usage rate:	50 gpcd	
Daily use:	100 gpd				Daily use:	100 gpd	2011	14,000	42	Daily use:	100 gpd	
											Total:	28,000
System Size & Water Use		Backup Water Required		System Size & Water Use		Backup Water Required		System Size & Water Use		Backup Water Required		
Roofprint:	3,000 sq. ft.	Year	Amount (gallons)	% of total usage	Roofprint:	3,000 sq. ft.	Year	Amount (gallons)	% of total usage	Roofprint:	3,000 sq. ft.	
Cistern size:	20,000 gallons	2011	10,000	27	Cistern size:	20,000 gallons	2011	12,000	31	Cistern size:	20,000 gallons	
Occupancy:	2 persons	Total:	10,000		Occupancy:	2 persons	Total:	12,000		Occupancy:	2 persons	
Usage rate:	50 gpcd				Usage rate:	50 gpcd				Usage rate:	50 gpcd	
Daily use:	100 gpd				Daily use:	100 gpd				Daily use:	100 gpd	
System Size & Water Use		Backup Water Required		System Size & Water Use		Backup Water Required		System Size & Water Use		Backup Water Required		
Roofprint:	3,000 sq. ft.	Year	Amount (gallons)	% of total usage	Roofprint:	3,000 sq. ft.	Year	Amount (gallons)	% of total usage	Roofprint:	3,000 sq. ft.	
Cistern size:	20,000 gallons	2011	6,000	18	Cistern size:	20,000 gallons	2011	8,000	22	Cistern size:	20,000 gallons	
Occupancy:	2 persons	Total:	6,000		Occupancy:	2 persons	Total:	8,000		Occupancy:	2 persons	
Usage rate:	45 gpcd				Usage rate:	45 gpcd				Usage rate:	45 gpcd	
Daily use:	90 gpd				Daily use:	90 gpd				Daily use:	90 gpd	
System Size & Water Use		Backup Water Required		System Size & Water Use		Backup Water Required		System Size & Water Use		Backup Water Required		
Roofprint:	3,000 sq. ft.	Year	Amount (gallons)	% of total usage	Roofprint:	3,000 sq. ft.	Year	Amount (gallons)	% of total usage	Roofprint:	3,000 sq. ft.	
Cistern size:	20,000 gallons	2011	2,000	7	Cistern size:	20,000 gallons	2011	6,000	18	Cistern size:	20,000 gallons	
Occupancy:	2 persons	Total:	2,000		Occupancy:	2 persons	Total:	6,000		Occupancy:	2 persons	
Usage rate:	40 gpcd				Usage rate:	40 gpcd				Usage rate:	40 gpcd	
Daily use:	80 gpd				Daily use:	80 gpd				Daily use:	80 gpd	
System Size & Water Use		Backup Water Required		System Size & Water Use		Backup Water Required		System Size & Water Use		Backup Water Required		
Roofprint:	3,000 sq. ft.	Year	Amount (gallons)	% of total usage	Roofprint:	3,000 sq. ft.	Year	Amount (gallons)	% of total usage	Roofprint:	3,000 sq. ft.	
Cistern size:	20,000 gallons	NONE required			Cistern size:	20,000 gallons	2011	4,000	13	Cistern size:	20,000 gallons	
Curtailment vol:	3,000 gallons				Curtailment vol:	3,000 gallons	Total:	4,000		Curtailment vol:	3,000 gallons	
Curtailment rate:	0.7 + irr.				Curtailment rate:	0.7 + irr.				Curtailment rate:	0.7 + irr.	
Occupancy:	2 persons				Occupancy:	2 persons				Occupancy:	2 persons	
Usage rate:	50 gpcd				Usage rate:	50 gpcd				Usage rate:	50 gpcd	
Daily use:	100 gpd				Daily use:	100 gpd				Daily use:	100 gpd	

Fredericksburg Rainwater Harvesting Model Summary
Interior Use Only

House with 2.5 person occupancy		Backup Water Required		
System Size & Water Use		Year	Amount (gallons)	% of total usage
Roofprint:	3,500 sq. ft.			
Cistern size:	20,000 gallons	2009	4,000	9
		2011	16,000	35
Occupancy:	2.5 persons	Total:	20,000	
Usage rate:	50 gpcd			
Daily use:	125 gpd			

System Size & Water Use		Backup Water Required		
System Size & Water Use		Year	Amount (gallons)	% of total usage
Roofprint:	3,500 sq. ft.			
Cistern size:	20,000 gallons	2011	12,000	29
Occupancy:	2.5 persons	Total:	12,000	
Usage rate:	45 gpcd			
Daily use:	112.5 gpd			

System Size & Water Use		Backup Water Required		
System Size & Water Use		Year	Amount (gallons)	% of total usage
Roofprint:	3,500 sq. ft.			
Cistern size:	20,000 gallons	2011	8,000	22
Occupancy:	2.5 persons	Total:	8,000	
Usage rate:	40 gpcd			
Daily use:	100 gpd			

System Size & Water Use		Backup Water Required		
System Size & Water Use		Year	Amount (gallons)	% of total usage
Roofprint:	3,500 sq. ft.			
Cistern size:	20,000 gallons	2009	4,000	9
Curtailment vol:	3,750 gallons	2011	10,000	27
Curtailment rate:	0.7 + irr.	Total:	14,000	
Occupancy:	2.5 persons			
Usage rate:	50 gpcd			
Daily use:	125 gpd			

Fredericksburg Rainwater Harvesting Model Summary
Interior Use & Irrigation

House with 2.5 person occupancy, 1500 sq. ft. irrigated area		Backup Water Required		
System Size & Water Use		Year	Amount (gallons)	% of total usage
Roofprint:	3,500 sq. ft.			
Cistern size:	20,000 gallons			
Occupancy:	2.5 persons			
Usage rate:	2.5 gpcd			
Daily use:	125 gpd			

System Size & Water Use		Backup Water Required		
System Size & Water Use		Year	Amount (gallons)	% of total usage
Roofprint:	3,500 sq. ft.			
Cistern size:	20,000 gallons			
Occupancy:	2.5 persons			
Usage rate:	45 gpcd			
Daily use:	112.5 gpd			

System Size & Water Use		Backup Water Required		
System Size & Water Use		Year	Amount (gallons)	% of total usage
Roofprint:	3,500 sq. ft.			
Cistern size:	20,000 gallons			
Occupancy:	2.5 persons			
Usage rate:	40 gpcd			
Daily use:	100 gpd			

System Size & Water Use		Backup Water Required		
System Size & Water Use		Year	Amount (gallons)	% of total usage
Roofprint:	3,500 sq. ft.			
Cistern size:	20,000 gallons			
Occupancy:	2.5 persons			
Usage rate:	50 gpcd			
Daily use:	125 gpd			

Fredericksburg Rainwater Harvesting Model Summary
Interior Use & Irrigation with Wastewater Reuse

House with 2.5 person occupancy, 1500 sq. ft. irrigated area		Backup Water Required		
System Size & Water Use		Year	Amount (gallons)	% of total usage
Roofprint:	3,500 sq. ft.			
Cistern size:	20,000 gallons	2000	2,000	4
		2009	4,000	9
Occupancy:	2.5 persons	2011	20,000	41
Usage rate:	50 gpcd	Total:	26,000	
Daily use:	125 gpd			

System Size & Water Use		Backup Water Required		
System Size & Water Use		Year	Amount (gallons)	% of total usage
Roofprint:	3,500 sq. ft.			
Cistern size:	20,000 gallons	2011	16,000	35
Occupancy:	2.5 persons	Total:	16,000	
Usage rate:	45 gpcd			
Daily use:	112.5 gpd			

System Size & Water Use		Backup Water Required		
System Size & Water Use		Year	Amount (gallons)	% of total usage
Roofprint:	3,500 sq. ft.			
Cistern size:	20,000 gallons	2011	12,000	29
Occupancy:	2.5 persons	Total:	12,000	
Usage rate:	40 gpcd			
Daily use:	100 gpd			

System Size & Water Use		Backup Water Required		
System Size & Water Use		Year	Amount (gallons)	% of total usage
Roofprint:	3,500 sq. ft.			
Cistern size:	20,000 gallons	2009	4,000	9
Curtailment vol:	3,750 gallons	2011	10,000	27
Curtailment rate:	0.7 + irr.	Total:	14,000	
Occupancy:	2.5 persons			
Usage rate:	50 gpcd			
Daily use:	125 gpd			

Fredericksburg Rainwater Harvesting Model Summary
Interior Use Only

House with 3 person occupancy		Backup Water Required		
System Size & Water Use		Year	Amount (gallons)	% of total usage
Roofprint:	4,000 sq. ft.			
Cistern size:	25,000 gallons	2009	6,000	11
		2011	20,000	37
Occupancy:	3 persons	Total:	26,000	
Usage rate:	50 gpcd			
Daily use:	150 gpd			

System Size & Water Use		Backup Water Required		
System Size & Water Use		Year	Amount (gallons)	% of total usage
Roofprint:	4,000 sq. ft.			
Cistern size:	25,000 gallons	2011	14,000	28
Occupancy:	3 persons	Total:	14,000	
Usage rate:	45 gpcd			
Daily use:	135 gpd			

System Size & Water Use		Backup Water Required		
System Size & Water Use		Year	Amount (gallons)	% of total usage
Roofprint:	4,000 sq. ft.			
Cistern size:	25,000 gallons	2011	8,000	18
Occupancy:	3 persons	Total:	8,000	
Usage rate:	40 gpcd			
Daily use:	120 gpd			

System Size & Water Use		Backup Water Required		
System Size & Water Use		Year	Amount (gallons)	% of total usage
Roofprint:	4,000 sq. ft.			
Cistern size:	25,000 gallons	2009	4,000	8
Curtailment vol:	4,500 gallons	2011	12,000	27
Curtailment rate:	0.7 + irr.	Total:	16,000	
Occupancy:	3 persons			
Usage rate:	50 gpcd			
Daily use:	150 gpd			

Fredericksburg Rainwater Harvesting Model Summary
Interior Use & Irrigation

House with 3 person occupancy, 1800 sq. ft. irrigated area		Backup Water Required		
System Size & Water Use		Year	Amount (gallons)	% of total usage
Roofprint:	4,000 sq. ft.			
Cistern size:	25,000 gallons			
Occupancy:	3 persons			
Usage rate:	50 gpcd			
Daily use:	150 gpd			

System Size & Water Use		Backup Water Required		
System Size & Water Use		Year	Amount (gallons)	% of total usage
Roofprint:	4,000 sq. ft.			
Cistern size:	25,000 gallons			
Occupancy:	3 persons			
Usage rate:	45 gpcd			
Daily use:	135 gpd			

System Size & Water Use		Backup Water Required		
System Size & Water Use		Year	Amount (gallons)	% of total usage
Roofprint:	4,000 sq. ft.			
Cistern size:	25,000 gallons			
Occupancy:	3 persons			
Usage rate:	40 gpcd			
Daily use:	120 gpd			

System Size & Water Use		Backup Water Required		
System Size & Water Use		Year	Amount (gallons)	% of total usage
Roofprint:	4,000 sq. ft.			
Cistern size:	25,000 gallons			
Occupancy:	3 persons			
Usage rate:	50 gpcd			
Daily use:	150 gpd			

Fredericksburg Rainwater Harvesting Model Summary
Interior Use & Irrigation with Wastewater Reuse

House with 3 person occupancy, 1800 sq. ft. irrigated area		Backup Water Required		
System Size & Water Use		Year	Amount (gallons)	% of total usage
Roofprint:	4,000 sq. ft.			
Cistern size:	25,000 gallons	2000	4,000	7
		2008	2,000	4
Occupancy:	3 persons	2009	4,000	7
Usage rate:	50 gpcd	2011	24,000	41
Daily use:	150 gpd	Total:	34,000	

System Size & Water Use		Backup Water Required		
System Size & Water Use		Year	Amount (gallons)	% of total usage
Roofprint:	4,000 sq. ft.			
Cistern size:	25,000 gallons	2009	2,000	4
Occupancy:	3 persons	2011	18,000	33
Usage rate:	45 gpcd	Total:	20,000	
Daily use:	135 gpd			

System Size & Water Use		Backup Water Required		
System Size & Water Use		Year	Amount (gallons)	% of total usage
Roofprint:	4,000 sq. ft.			
Cistern size:	25,000 gallons	2011	14,000	28
Occupancy:	3 persons	Total:	14,000	
Usage rate:	40 gpcd			
Daily use:	120 gpd			

System Size & Water Use		Backup Water Required		
System Size & Water Use		Year	Amount (gallons)	% of total usage
Roofprint:	4,000 sq. ft.			
Cistern size:	25,000 gallons	2000	2,000	4
Curtailment vol:	4,500 gallons	2008	2,000	4
Curtailment rate:	0.7 + irr.	2009	2,000	4
Occupancy:	3 persons	2011	12,000	27
Usage rate:	50 gpcd	Total:	18,000	
Daily use:	150 gpd			

Fredericksburg Rainwater Harvesting Model Summary
Interior Use Only

System Size & Water Use			Backup Water Required		
	Year	Amount (gallons)	% of total usage		
Roofprint:	6,000	sq. ft.			
Cistern size:	50,000	gallons			
Occupancy:	4	persons			
Usage rate:	60	gpcd			
Daily use:	240	gpd			
	2009	4,000	5		
	2011	22,000	25		
	Total:	26,000			

System Size & Water Use			Backup Water Required		
	Year	Amount (gallons)	% of total usage		
Roofprint:	6,000	sq. ft.			
Cistern size:	50,000	gallons			
Curtailment vol:	7,200	gallons			
Curtailment rate:	0.7	+ irr.			
Occupancy:	4	persons			
Usage rate:	60	gpcd			
Daily use:	240	gpd			
	2009	2,000	2		
	2011	12,000	16		
	Total:	14,000			

System Size & Water Use			Backup Water Required		
	Year	Amount (gallons)	% of total usage		
Roofprint:	6,500	sq. ft.			
Cistern size:	55,000	gallons			
Occupancy:	4	persons			
Usage rate:	60	gpcd			
Daily use:	240	gpd			
	2011	14,000	16		
	Total:	14,000			

System Size & Water Use			Backup Water Required		
	Year	Amount (gallons)	% of total usage		
Roofprint:	6,500	sq. ft.			
Cistern size:	55,000	gallons			
Curtailment vol:	7,200	gallons			
Curtailment rate:	0.7	+ irr.			
Occupancy:	4	persons			
Usage rate:	60	gpcd			
Daily use:	240	gpd			
	2011	8,000	10		
	Total:	8,000			

Fredericksburg Rainwater Harvesting Model Summary
Interior Use & Irrigation

System Size & Water Use			Backup Water Required		
	Year	Amount (gallons)	% of total usage		
Roofprint:	6,000	sq. ft.			
Cistern size:	50,000	gallons			
Occupancy:	4	persons			
Usage rate:	45	gpcd			
Daily use:	180	gpd			
	2009	4,000	5		
	2011	24,000	27		
	Total:	28,000			

System Size & Water Use			Backup Water Required		
	Year	Amount (gallons)	% of total usage		
Roofprint:	6,000	sq. ft.			
Cistern size:	50,000	gallons			
Curtailment vol:	7,200	gallons			
Curtailment rate:	0.7	+ irr.			
Occupancy:	4	persons			
Usage rate:	60	gpcd			
Daily use:	240	gpd			
	2009	2,000	2		
	2011	14,000	19		
	Total:	16,000			

System Size & Water Use			Backup Water Required		
	Year	Amount (gallons)	% of total usage		
Roofprint:	6,500	sq. ft.			
Cistern size:	55,000	gallons			
Occupancy:	4	persons			
Usage rate:	60	gpcd			
Daily use:	240	gpd			
	2011	16,000	18		
	Total:	16,000			

System Size & Water Use			Backup Water Required		
	Year	Amount (gallons)	% of total usage		
Roofprint:	6,500	sq. ft.			
Cistern size:	55,000	gallons			
Curtailment vol:	7,200	gallons			
Curtailment rate:	0.7	+ irr.			
Occupancy:	4	persons			
Usage rate:	60	gpcd			
Daily use:	240	gpd			
	2011	10,000	13		
	Total:	10,000			

Fredericksburg Rainwater Harvesting Model Summary
Interior Use & Irrigation with Wastewater Reuse

System Size & Water Use			Backup Water Required		
	Year	Amount (gallons)	% of total usage		
Roofprint:	6,000	sq. ft.			
Cistern size:	50,000	gallons			
Occupancy:	4	persons			
Usage rate:	45	gpcd			
Daily use:	180	gpd			
	2009	4,000	5		
	2011	24,000	27		
	Total:	28,000			

System Size & Water Use			Backup Water Required		
	Year	Amount (gallons)	% of total usage		
Roofprint:	6,000	sq. ft.			
Cistern size:	50,000	gallons			
Curtailment vol:	7,200	gallons			
Curtailment rate:	0.7	+ irr.			
Occupancy:	4	persons			
Usage rate:	60	gpcd			
Daily use:	240	gpd			
	2009	2,000	2		
	2011	14,000	19		
	Total:	16,000			

System Size & Water Use			Backup Water Required		
	Year	Amount (gallons)	% of total usage		
Roofprint:	6,500	sq. ft.			
Cistern size:	55,000	gallons			
Occupancy:	4	persons			
Usage rate:	60	gpcd			
Daily use:	240	gpd			
	2011	16,000	18		
	Total:	16,000			

System Size & Water Use			Backup Water Required		
	Year	Amount (gallons)	% of total usage		
Roofprint:	6,500	sq. ft.			
Cistern size:	55,000	gallons			
Curtailment vol:	7,200	gallons			
Curtailment rate:	0.7	+ irr.			
Occupancy:	4	persons			
Usage rate:	60	gpcd			
Daily use:	240	gpd			
	2011	10,000	13		
	Total:	10,000			

Requirements for house with 4 person occupancy, 2,400 sq. ft. irrigated area with no wastewater irrigation

System Size & Water Use			Backup Water Required			System Size & Water Use			Backup Water Required		
	Year	Amount (gallons)	% of total usage				Year	Amount (gallons)	% of total usage		
Roofprint:	7,500	sq. ft.				Roofprint:	7,500	sq. ft.			
Cistern size:	55,000	gallons				Cistern size:	55,000	gallons			
Occupancy:	4	persons				Occupancy:	4	persons			
Usage rate:	50	gpcd				Usage rate:	40	gpcd			
Daily use:	200	gpd				Daily use:	160	gpd			
	2011	34,000	31				2011	18,000	19		
	Total:	34,000					Total:	18,000			

System Size & Water Use			Backup Water Required			System Size & Water Use			Backup Water Required		
	Year	Amount (gallons)	% of total usage				Year	Amount (gallons)	% of total usage		
Roofprint:	7,500	sq. ft.				Roofprint:	7,500	sq. ft.			
Cistern size:	55,000	gallons				Cistern size:	55,000	gallons			
Curtailment vol:	6,000	gallons				Curtailment vol:	6,000	gallons			
Curtailment rate:	1.0	irr. only				Curtailment rate:	1.0	irr. only			
Occupancy:	4	persons				Occupancy:	4	persons			
Usage rate:	50	gpcd				Usage rate:	40	gpcd			
Daily use:	200	gpd				Daily use:	160	gpd			
	2011	14,000	16				2011	6,000	7		
	Total:	14,000					Total:	6,000			

Appendix H – Menard Rainwater Harvesting Modeling Summary

Menard Rainwater Harvesting Model Summary					Menard Rainwater Harvesting Model Summary					Menard Rainwater Harvesting Model Summary				
Interior Use Only					Interior Use & Irrigation					Interior Use & Irrigation with Wastewater Reuse				
House with 2 person occupancy					House with 2 person occupancy, 1200 sq. ft. irrigated area					House with 2 person occupancy, 1200 sq. ft. irrigated area				
Backup Water Required					Backup Water Required					Backup Water Required				
System Size & Water Use					System Size & Water Use					System Size & Water Use				
Roofprint:	3,000	sq. ft.			Roofprint:	3,000	sq. ft.			Roofprint:	3,000	sq. ft.		
Cistern size:	15,000	gallons			Cistern size:	15,000	gallons			Cistern size:	15,000	gallons		
Occupancy:	2	persons			Occupancy:	2	persons			Occupancy:	2	persons		
Usage rate:	50	gpcd			Usage rate:	50	gpcd			Usage rate:	50	gpcd		
Daily use:	100	gpd			Daily use:	100	gpd			Daily use:	100	gpd		
Year					Year					Year				
Amount (gallons)					Amount (gallons)					Amount (gallons)				
% of total usage					% of total usage					% of total usage				
1988	4,000		11		1988	4,000		11		1988	4,000		11	
1996	2,000		5		1996	2,000		5		1996	2,000		5	
1998	2,000		5		1998	2,000		5		1998	2,000		5	
1999	2,000		5		1999	2,000		5		1999	2,000		5	
2000	8,000		22		2000	8,000		22		2000	8,000		22	
2006	2,000		5		2006	2,000		5		2006	2,000		5	
2011	14,000		38		2011	14,000		38		2011	14,000		38	
Total:	34,000				Total:	34,000				Total:	44,000			

Menard Rainwater Harvesting Model Summary					Menard Rainwater Harvesting Model Summary					Menard Rainwater Harvesting Model Summary				
Interior Use Only					Interior Use & Irrigation					Interior Use & Irrigation with Wastewater Reuse				
House with 2 person occupancy					House with 2 person occupancy, 1200 sq. ft. irrigated area					House with 2 person occupancy, 1200 sq. ft. irrigated area				
Backup Water Required					Backup Water Required					Backup Water Required				
System Size & Water Use					System Size & Water Use					System Size & Water Use				
Roofprint:	3,000	sq. ft.			Roofprint:	3,000	sq. ft.			Roofprint:	3,000	sq. ft.		
Cistern size:	20,000	gallons			Cistern size:	20,000	gallons			Cistern size:	20,000	gallons		
Occupancy:	2	persons			Occupancy:	2	persons			Occupancy:	2	persons		
Usage rate:	50	gpcd			Usage rate:	50	gpcd			Usage rate:	50	gpcd		
Daily use:	100	gpd			Daily use:	100	gpd			Daily use:	100	gpd		
Year					Year					Year				
Amount (gallons)					Amount (gallons)					Amount (gallons)				
% of total usage					% of total usage					% of total usage				
2000	8,000		22		2000	8,000		22		1999	2,000		5	
2011	10,000		27		2011	10,000		27		2000	8,000		21	
Total:	18,000				Total:	18,000				2011	12,000		31	
Total:	18,000				Total:	18,000				Total:	22,000			

Menard Rainwater Harvesting Model Summary Interior Use Only				Menard Rainwater Harvesting Model Summary Interior Use & Irrigation				Menard Rainwater Harvesting Model Summary Interior Use & Irrigation with Wastewater Reuse			
House with 2.5 person occupancy				House with 2.5 person occupancy, 1500 sq. ft. irrigated area				House with 2.5 person occupancy, 1500 sq. ft. irrigated area			
System Size & Water Use		Backup Water Required		System Size & Water Use		Backup Water Required		System Size & Water Use		Backup Water Required	
Roofprint:	4,000 sq. ft.	Year	Amount (gallons)	% of total usage	Roofprint:	4,000 sq. ft.	Year	Amount (gallons)	% of total usage	Roofprint:	4,000 sq. ft.
Cistern size:	20,000 gallons	1988	2,000	4	Cistern size:	20,000 gallons	1988	2,000	4	Cistern size:	20,000 gallons
Occupancy:	2.5 persons	2000	6,000	13	Occupancy:	2.5 persons	2000	6,000	13	Occupancy:	2.5 persons
Usage rate:	50 gpcd	2011	14,000	31	Usage rate:	50 gpcd	2011	14,000	31	Usage rate:	50 gpcd
Daily use:	125 gpd	Total:	22,000		Daily use:	125 gpd	Total:	22,000		Daily use:	125 gpd
System Size & Water Use		Backup Water Required		System Size & Water Use		Backup Water Required		System Size & Water Use		Backup Water Required	
Roofprint:	4,000 sq. ft.	Year	Amount (gallons)	% of total usage	Roofprint:	4,000 sq. ft.	Year	Amount (gallons)	% of total usage	Roofprint:	4,000 sq. ft.
Cistern size:	20,000 gallons	2000	2,000	5	Cistern size:	20,000 gallons	2000	2,000	5	Cistern size:	20,000 gallons
Occupancy:	2.5 persons	2011	10,000	24	Occupancy:	2.5 persons	2011	10,000	24	Occupancy:	2.5 persons
Usage rate:	45 gpcd	Total:	12,000		Usage rate:	45 gpcd	Total:	12,000		Usage rate:	45 gpcd
Daily use:	112.5 gpd				Daily use:	112.5 gpd				Daily use:	112.5 gpd
System Size & Water Use		Backup Water Required		System Size & Water Use		Backup Water Required		System Size & Water Use		Backup Water Required	
Roofprint:	4,000 sq. ft.	Year	Amount (gallons)	% of total usage	Roofprint:	4,000 sq. ft.	Year	Amount (gallons)	% of total usage	Roofprint:	4,000 sq. ft.
Cistern size:	20,000 gallons	2011	6,000	16	Cistern size:	20,000 gallons	2011	6,000	16	Cistern size:	20,000 gallons
Occupancy:	2.5 persons	Total:	6,000		Occupancy:	2.5 persons	Total:	6,000		Occupancy:	2.5 persons
Usage rate:	40 gpcd				Usage rate:	40 gpcd				Usage rate:	40 gpcd
Daily use:	100 gpd				Daily use:	100 gpd				Daily use:	100 gpd
System Size & Water Use		Backup Water Required		System Size & Water Use		Backup Water Required		System Size & Water Use		Backup Water Required	
Roofprint:	4,000 sq. ft.	Year	Amount (gallons)	% of total usage	Roofprint:	4,000 sq. ft.	Year	Amount (gallons)	% of total usage	Roofprint:	4,000 sq. ft.
Cistern size:	20,000 gallons	2011	4,000	12	Cistern size:	20,000 gallons	2011	4,000	12	Cistern size:	20,000 gallons
Curtailment vol:	3,750 gallons	Total:	4,000		Curtailment vol:	3,750 gallons	Total:	4,000		Curtailment vol:	3,750 gallons
Curtailment rate:	0.7 + irr.				Curtailment rate:	0.7 + irr.				Curtailment rate:	0.7 + irr.
Occupancy:	2.5 persons				Occupancy:	2.5 persons				Occupancy:	2.5 persons
Usage rate:	50 gpcd				Usage rate:	50 gpcd				Usage rate:	50 gpcd
Daily use:	125 gpd				Daily use:	125 gpd				Daily use:	125 gpd

Menard Rainwater Harvesting Model Summary Interior Use Only				Menard Rainwater Harvesting Model Summary Interior Use & Irrigation				Menard Rainwater Harvesting Model Summary Interior Use & Irrigation with Wastewater Reuse			
House with 3 person occupancy				House with 3 person occupancy, 1800 sq. ft. irrigated area				House with 3 person occupancy, 1800 sq. ft. irrigated area			
System Size & Water Use		Backup Water Required		System Size & Water Use		Backup Water Required		System Size & Water Use		Backup Water Required	
Roofprint:	4,500 sq. ft.	Year	Amount (gallons)	% of total usage	Roofprint:	4,500 sq. ft.	Year	Amount (gallons)	% of total usage	Roofprint:	4,500 sq. ft.
Cistern size:	25,000 gallons	1988	2,000	4	Cistern size:	25,000 gallons	1988	2,000	4	Cistern size:	25,000 gallons
Occupancy:	3 persons	1999	2,000	4	Occupancy:	3 persons	1999	2,000	4	Occupancy:	3 persons
Usage rate:	50 gpcd	2000	10,000	18	Usage rate:	50 gpcd	2000	10,000	18	Usage rate:	50 gpcd
Daily use:	150 gpd	2011	18,000	33	Daily use:	150 gpd	2011	18,000	33	Daily use:	150 gpd
		Total:	32,000				Total:	32,000			
System Size & Water Use		Backup Water Required		System Size & Water Use		Backup Water Required		System Size & Water Use		Backup Water Required	
Roofprint:	4,500 sq. ft.	Year	Amount (gallons)	% of total usage	Roofprint:	4,500 sq. ft.	Year	Amount (gallons)	% of total usage	Roofprint:	4,500 sq. ft.
Cistern size:	25,000 gallons	2000	4,000	8	Cistern size:	25,000 gallons	2000	4,000	8	Cistern size:	25,000 gallons
Occupancy:	3 persons	2011	12,000	24	Occupancy:	3 persons	2011	12,000	24	Occupancy:	3 persons
Usage rate:	45 gpcd	Total:	16,000		Usage rate:	45 gpcd	Total:	16,000		Usage rate:	45 gpcd
Daily use:	135 gpd				Daily use:	135 gpd				Daily use:	135 gpd
System Size & Water Use		Backup Water Required		System Size & Water Use		Backup Water Required		System Size & Water Use		Backup Water Required	
Roofprint:	4,500 sq. ft.	Year	Amount (gallons)	% of total usage	Roofprint:	4,500 sq. ft.	Year	Amount (gallons)	% of total usage	Roofprint:	4,500 sq. ft.
Cistern size:	25,000 gallons	2011	6,000	14	Cistern size:	25,000 gallons	2011	6,000	14	Cistern size:	25,000 gallons
Occupancy:	3 persons	Total:	6,000		Occupancy:	3 persons	Total:	6,000		Occupancy:	3 persons
Usage rate:	40 gpcd				Usage rate:	40 gpcd				Usage rate:	40 gpcd
Daily use:	120 gpd				Daily use:	120 gpd				Daily use:	120 gpd
System Size & Water Use		Backup Water Required		System Size & Water Use		Backup Water Required		System Size & Water Use		Backup Water Required	
Roofprint:	4,500 sq. ft.	Year	Amount (gallons)	% of total usage	Roofprint:	4,500 sq. ft.	Year	Amount (gallons)	% of total usage	Roofprint:	4,500 sq. ft.
Cistern size:	25,000 gallons	2000	6,000	13	Cistern size:	25,000 gallons	2000	6,000	13	Cistern size:	25,000 gallons
Curtailment vol:	4,500 gallons	2011	8,000	18	Curtailment vol:	4,500 gallons	2011	8,000	18	Curtailment vol:	4,500 gallons
Curtailment rate:	0.7 + irr.	Total:	14,000		Curtailment rate:	0.7 + irr.	Total:	14,000		Curtailment rate:	0.7 + irr.
Occupancy:	3 persons				Occupancy:	3 persons				Occupancy:	3 persons
Usage rate:	50 gpcd				Usage rate:	50 gpcd				Usage rate:	50 gpcd
Daily use:	150 gpd				Daily use:	150 gpd				Daily use:	150 gpd

Menard Rainwater Harvesting Model Summary Interior Use Only				Menard Rainwater Harvesting Model Summary Interior Use & Irrigation				Menard Rainwater Harvesting Model Summary Interior Use & Irrigation with Wastewater Reuse			
House with 4 person occupancy				House with 4 person occupancy, 2400 sq. ft. irrigated area				House with 4 person occupancy, 2400 sq. ft. irrigated area			
System Size & Water Use		Backup Water Required		System Size & Water Use		Backup Water Required		System Size & Water Use		Backup Water Required	
Roofprint:	5,500 sq. ft.	Year	Amount (gallons)	% of total usage	Roofprint:	5,500 sq. ft.	Year	Amount (gallons)	% of total usage	Roofprint:	5,500 sq. ft.
Cistern size:	45,000 gallons	1999	2,000	3	Cistern size:	45,000 gallons	2000	6,000	9	Cistern size:	45,000 gallons
Occupancy:	4 persons	2011	14,000	22	Occupancy:	4 persons	2011	12,000	17	Occupancy:	4 persons
Usage rate:	50 gpcd	Total:	32,000		Usage rate:	50 gpcd	Total:	18,000		Usage rate:	50 gpcd
Daily use:	200 gpd				Daily use:	180 gpd				Daily use:	200 gpd
System Size & Water Use		Backup Water Required		System Size & Water Use		Backup Water Required		System Size & Water Use		Backup Water Required	
Roofprint:	5,500 sq. ft.	Year	Amount (gallons)	% of total usage	Roofprint:	5,500 sq. ft.	Year	Amount (gallons)	% of total usage	Roofprint:	5,500 sq. ft.
Cistern size:	45,000 gallons	2011	6,000	9	Cistern size:	45,000 gallons	2000	6,000	9	Cistern size:	45,000 gallons
Occupancy:	4 persons	Total:	6,000		Occupancy:	4 persons	2011	12,000	17	Occupancy:	4 persons
Usage rate:	45 gpcd				Usage rate:	45 gpcd	Total:	18,000		Usage rate:	45 gpcd
Daily use:	180 gpd				Daily use:	180 gpd				Daily use:	180 gpd
System Size & Water Use		Backup Water Required		System Size & Water Use		Backup Water Required		System Size & Water Use		Backup Water Required	
Roofprint:	5,500 sq. ft.	Year	Amount (gallons)	% of total usage	Roofprint:	5,500 sq. ft.	Year	Amount (gallons)	% of total usage	Roofprint:	5,500 sq. ft.
Cistern size:	45,000 gallons	NONE required			Cistern size:	45,000 gallons	2011	6,000	9	Cistern size:	45,000 gallons
Occupancy:	4 persons				Occupancy:	4 persons	Total:	6,000		Occupancy:	4 persons
Usage rate:	40 gpcd				Usage rate:	40 gpcd				Usage rate:	40 gpcd
Daily use:	160 gpd				Daily use:	160 gpd				Daily use:	160 gpd
System Size & Water Use		Backup Water Required		System Size & Water Use		Backup Water Required		System Size & Water Use		Backup Water Required	
Roofprint:	5,500 sq. ft.	Year	Amount (gallons)	% of total usage	Roofprint:	5,500 sq. ft.	Year	Amount (gallons)	% of total usage	Roofprint:	5,500 sq. ft.
Cistern size:	45,000 gallons	1999	2,000	3	Cistern size:	45,000 gallons	2011	6,000	9	Cistern size:	45,000 gallons
Curtailment vol:	6,000 gallons	2009	10,000	16	Curtailment vol:	6,000 gallons	2009	10,000	16	Curtailment vol:	6,000 gallons
Curtailment rate:	0.7 + irr.	2011	8,000	13	Curtailment rate:	0.7 + irr.	2011	8,000	12	Curtailment rate:	0.7 + irr.
Occupancy:	4 persons	Total:	20,000		Occupancy:	4 persons	Total:	22,000		Occupancy:	4 persons
Usage rate:	50 gpcd				Usage rate:	50 gpcd				Usage rate:	50 gpcd
Daily use:	200 gpd				Daily use:	200 gpd				Daily use:	200 gpd

Menard Rainwater Harvesting Model Summary Interior Use Only				Menard Rainwater Harvesting Model Summary Interior Use & Irrigation				Menard Rainwater Harvesting Model Summary Interior Use & Irrigation with Wastewater Reuse			
House with 4 person occupancy				House with 4 person occupancy, 2400 sq. ft. irrigated area				House with 4 person occupancy, 2400 sq. ft. irrigated area			
System Size & Water Use		Backup Water Required		System Size & Water Use		Backup Water Required		System Size & Water Use		Backup Water Required	
Roofprint:	6,000 sq. ft.	Year	Amount (gallons)	% of total usage	Roofprint:	6,000 sq. ft.	Year	Amount (gallons)	% of total usage	Roofprint:	6,000 sq. ft.
Cistern size:	45,000 gallons	2000	6,000	8	Cistern size:	45,000 gallons	2011	10,000	13	Cistern size:	45,000 gallons
Occupancy:	4 persons	2011	12,000	16	Occupancy:	4 persons	2011	16,000	21	Occupancy:	4 persons
Usage rate:	50 gpcd	Total:	18,000		Usage rate:	50 gpcd	Total:	26,000		Usage rate:	50 gpcd
Daily use:	200 gpd				Daily use:	200 gpd				Daily use:	200 gpd
System Size & Water Use		Backup Water Required		System Size & Water Use		Backup Water Required		System Size & Water Use		Backup Water Required	
Roofprint:	6,000 sq. ft.	Year	Amount (gallons)	% of total usage	Roofprint:	6,000 sq. ft.	Year	Amount (gallons)	% of total usage	Roofprint:	6,000 sq. ft.
Cistern size:	45,000 gallons	2011	2,000	3	Cistern size:	45,000 gallons	2011	10,000	14	Cistern size:	45,000 gallons
Occupancy:	4 persons	Total:	2,000		Occupancy:	4 persons	Total:	10,000		Occupancy:	4 persons
Usage rate:	45 gpcd				Usage rate:	45 gpcd				Usage rate:	45 gpcd
Daily use:	180 gpd				Daily use:	180 gpd				Daily use:	180 gpd
System Size & Water Use		Backup Water Required		System Size & Water Use		Backup Water Required		System Size & Water Use		Backup Water Required	
Roofprint:	6,000 sq. ft.	Year	Amount (gallons)	% of total usage	Roofprint:	6,000 sq. ft.	Year	Amount (gallons)	% of total usage	Roofprint:	6,000 sq. ft.
Cistern size:	45,000 gallons	NONE required			Cistern size:	45,000 gallons	2011	4,000	6	Cistern size:	45,000 gallons
Occupancy:	4 persons				Occupancy:	4 persons	2011	6,000	9	Occupancy:	4 persons
Usage rate:	40 gpcd				Usage rate:	40 gpcd	Total:	10,000		Usage rate:	40 gpcd
Daily use:	160 gpd				Daily use:	160 gpd				Daily use:	160 gpd
System Size & Water Use		Backup Water Required		System Size & Water Use		Backup Water Required		System Size & Water Use		Backup Water Required	
Roofprint:	6,000 sq. ft.	Year	Amount (gallons)	% of total usage	Roofprint:	6,000 sq. ft.	Year	Amount (gallons)	% of total usage	Roofprint:	6,000 sq. ft.
Cistern size:	45,000 gallons	2000	2,000	3	Cistern size:	45,000 gallons	2000	4,000	6	Cistern size:	45,000 gallons
Curtailment vol:	6,000 gallons	2011	6,000	9	Curtailment vol:	6,000 gallons	2011	6,000	9	Curtailment vol:	6,000 gallons
Curtailment rate:	0.7 + irr.	Total:	8,000		Curtailment rate:	0.7 + irr.	Total:	10,000		Curtailment rate:	0.7 + irr.
Occupancy:	4 persons				Occupancy:	4 persons				Occupancy:	4 persons
Usage rate:	50 gpcd				Usage rate:	50 gpcd				Usage rate:	50 gpcd
Daily use:	200 gpd				Daily use:	200 gpd				Daily use:	200 gpd

Menard Rainwater Harvesting Model Summary				Menard Rainwater Harvesting Model Summary				Menard Rainwater Harvesting Model Summary			
Interior Use Only				Interior Use & Irrigation				Interior Use & Irrigation with Wastewater Reuse			
House with 4 person occupancy				House with 4 person occupancy, 2400 sq. ft. irrigated area				House with 4 person occupancy, 2400 sq. ft. irrigated area			
System Size & Water Use				System Size & Water Use				System Size & Water Use			
Roofprint:	6,500	sq. ft.		Roofprint:	6,000	sq. ft.		Roofprint:	6,000	sq. ft.	
Cistern size:	50,000	gallons		Cistern size:	50,000	gallons		Cistern size:	50,000	gallons	
Occupancy:	4	persons		Occupancy:	4	persons		Occupancy:	4	persons	
Usage rate:	60	gpcd		Usage rate:	60	gpcd		Usage rate:	60	gpcd	
Daily use:	240	gpd		Daily use:	240	gpd		Daily use:	240	gpd	
Backup Water Required				Backup Water Required				Backup Water Required			
Year	Amount (gallons)	% of total usage		Year	Amount (gallons)	% of total usage		Year	Amount (gallons)	% of total usage	
1999	6,000	7		1999	6,000	7		1999	6,000	7	
2000	22,000	25		2000	22,000	25		2000	24,000	27	
2011	22,000	25		2011	22,000	25		2011	22,000	25	
Total:	50,000			Total:	50,000			Total:	52,000		
System Size & Water Use				System Size & Water Use				System Size & Water Use			
Roofprint:	6,500	sq. ft.		Roofprint:	6,500	sq. ft.		Roofprint:	6,500	sq. ft.	
Cistern size:	50,000	gallons		Cistern size:	50,000	gallons		Cistern size:	50,000	gallons	
Curtailment vol:	7,200	gallons		Curtailment vol:	7,200	gallons		Curtailment vol:	7,200	gallons	
Curtailment rate:	0.7	+ irr.		Curtailment rate:	0.7	+ irr.		Curtailment rate:	0.7	+ irr.	
Occupancy:	4	persons		Occupancy:	4	persons		Occupancy:	4	persons	
Usage rate:	60	gpcd		Usage rate:	60	gpcd		Usage rate:	60	gpcd	
Daily use:	240	gpd		Daily use:	240	gpd		Daily use:	240	gpd	
Backup Water Required				Backup Water Required				Backup Water Required			
Year	Amount (gallons)	% of total usage		Year	Amount (gallons)	% of total usage		Year	Amount (gallons)	% of total usage	
1999	4,000	5		1999	4,000	5		1999	2,000	2	
2000	14,000	19		2000	14,000	19		2000	14,000	19	
2011	12,000	16		2011	12,000	16		2011	14,000	18	
Total:	30,000			Total:	30,000			Total:	30,000		
System Size & Water Use				System Size & Water Use				System Size & Water Use			
Roofprint:	7,000	sq. ft.		Roofprint:	7,000	sq. ft.		Roofprint:	7,000	sq. ft.	
Cistern size:	55,000	gallons		Cistern size:	55,000	gallons		Cistern size:	55,000	gallons	
Occupancy:	4	persons		Occupancy:	4	persons		Occupancy:	4	persons	
Usage rate:	60	gpcd		Usage rate:	60	gpcd		Usage rate:	60	gpcd	
Daily use:	240	gpd		Daily use:	240	gpd		Daily use:	240	gpd	
Backup Water Required				Backup Water Required				Backup Water Required			
Year	Amount (gallons)	% of total usage		Year	Amount (gallons)	% of total usage		Year	Amount (gallons)	% of total usage	
2000	10,000	11		2000	10,000	11		2000	10,000	11	
2011	14,000	16		2011	14,000	16		2011	16,000	18	
Total:	24,000			Total:	24,000			Total:	26,000		
System Size & Water Use				System Size & Water Use				System Size & Water Use			
Roofprint:	7,000	sq. ft.		Roofprint:	7,000	sq. ft.		Roofprint:	7,000	sq. ft.	
Cistern size:	55,000	gallons		Cistern size:	55,000	gallons		Cistern size:	55,000	gallons	
Curtailment vol:	7,200	gallons		Curtailment vol:	7,200	gallons		Curtailment vol:	7,200	gallons	
Curtailment rate:	0.7	+ irr.		Curtailment rate:	0.7	+ irr.		Curtailment rate:	0.7	+ irr.	
Occupancy:	4	persons		Occupancy:	4	persons		Occupancy:	4	persons	
Usage rate:	60	gpcd		Usage rate:	60	gpcd		Usage rate:	60	gpcd	
Daily use:	240	gpd		Daily use:	240	gpd		Daily use:	240	gpd	
Backup Water Required				Backup Water Required				Backup Water Required			
Year	Amount (gallons)	% of total usage		Year	Amount (gallons)	% of total usage		Year	Amount (gallons)	% of total usage	
2000	4,000	5		2000	4,000	5		2000	4,000	5	
2011	8,000	10		2011	8,000	10		2011	8,000	10	
Total:	12,000			Total:	12,000			Total:	12,000		

Requirements for house with 4 person occupancy, 2,400 sq. ft. irrigated area with no wastewater irrigation											
System Size & Water Use				System Size & Water Use				System Size & Water Use			
Roofprint:	8,500	sq. ft.		Roofprint:	8,500	sq. ft.		Roofprint:	8,500	sq. ft.	
Cistern size:	60,000	gallons		Cistern size:	60,000	gallons		Cistern size:	60,000	gallons	
Occupancy:	4	persons		Occupancy:	4	persons		Occupancy:	4	persons	
Usage rate:	50	gpcd		Usage rate:	45	gpcd		Usage rate:	40	gpcd	
Daily use:	200	gpd		Daily use:	180	gpd		Daily use:	160	gpd	
Backup Water Required				Backup Water Required				Backup Water Required			
Year	Amount (gallons)	% of total usage		Year	Amount (gallons)	% of total usage		Year	Amount (gallons)	% of total usage	
2000	8,000	8		2000	20,000	20		2000	8,000	8	
2011	28,000	26		2011	20,000	20		2011	12,000	13	
Total:	36,000			Total:	20,000			Total:	12,000		
System Size & Water Use				System Size & Water Use				System Size & Water Use			
Roofprint:	8,500	sq. ft.		Roofprint:	8,500	sq. ft.		Roofprint:	8,500	sq. ft.	
Cistern size:	60,000	gallons		Cistern size:	60,000	gallons		Cistern size:	60,000	gallons	
Curtailment vol:	6,000	gallons		Curtailment vol:	6,000	gallons		Curtailment vol:	6,000	gallons	
Curtailment rate:	1.0	irr. only		Curtailment rate:	1.0	irr. only		Curtailment rate:	1.0	irr. only	
Occupancy:	4	persons		Occupancy:	4	persons		Occupancy:	4	persons	
Usage rate:	50	gpcd		Usage rate:	45	gpcd		Usage rate:	40	gpcd	
Daily use:	200	gpd		Daily use:	180	gpd		Daily use:	160	gpd	
Backup Water Required				Backup Water Required				Backup Water Required			
Year	Amount (gallons)	% of total usage		Year	Amount (gallons)	% of total usage		Year	Amount (gallons)	% of total usage	
2000	2,000	2		2000	8,000	9		2000	8,000	9	
2011	16,000	17		2011	8,000	9		2011	8,000	9	
Total:	18,000			Total:	8,000			Total:	8,000		

Appendix I – San Marcos Rainwater Harvesting Modeling Summary

San Marcos Rainwater Harvesting Model Summary Interior Use Only				San Marcos Rainwater Harvesting Model Summary Interior Use & Irrigation				San Marcos Rainwater Harvesting Model Summary Interior Use & Irrigation with Wastewater Reuse			
House with 2 person occupancy				House with 2 person occupancy, 1200 sq. ft. irrigated area				House with 2 person occupancy, 1200 sq. ft. irrigated area			
System Size & Water Use		Backup Water Required		System Size & Water Use		Backup Water Required		System Size & Water Use		Backup Water Required	
Rootprint:	2,500 sq. ft.	Year	Amount (gallons)	% of total usage	Rootprint:	2,500 sq. ft.	Year	Amount (gallons)	% of total usage	Rootprint:	2,500 sq. ft.
Cistern size:	15,000 gallons	2008	8,000	22	Cistern size:	15,000 gallons	2008	8,000	16	Cistern size:	15,000 gallons
Occupancy:	2 persons	2009	6,000	16	Occupancy:	2 persons	2009	6,000	16	Occupancy:	2 persons
Usage rate:	50 gpcd	2011	8,000	22	Usage rate:	50 gpcd	2011	8,000	22	Usage rate:	50 gpcd
Daily use:	100 gpd	Total:	22,000		Daily use:	100 gpd	Total:	22,000		Daily use:	100 gpd
System Size & Water Use		Backup Water Required		System Size & Water Use		Backup Water Required		System Size & Water Use		Backup Water Required	
Rootprint:	2,500 sq. ft.	Year	Amount (gallons)	% of total usage	Rootprint:	2,500 sq. ft.	Year	Amount (gallons)	% of total usage	Rootprint:	2,500 sq. ft.
Cistern size:	15,000 gallons	2008	4,000	12	Cistern size:	15,000 gallons	2008	4,000	12	Cistern size:	15,000 gallons
Occupancy:	2 persons	2009	2,000	6	Occupancy:	2 persons	2009	2,000	6	Occupancy:	2 persons
Usage rate:	45 gpcd	2011	4,000	12	Usage rate:	45 gpcd	2011	4,000	12	Usage rate:	45 gpcd
Daily use:	90 gpd	Total:	10,000		Daily use:	90 gpd	Total:	10,000		Daily use:	90 gpd
System Size & Water Use		Backup Water Required		System Size & Water Use		Backup Water Required		System Size & Water Use		Backup Water Required	
Rootprint:	2,500 sq. ft.	Year	Amount (gallons)	% of total usage	Rootprint:	2,500 sq. ft.	Year	Amount (gallons)	% of total usage	Rootprint:	2,500 sq. ft.
Cistern size:	15,000 gallons	2009	2,000	7	Cistern size:	15,000 gallons	2009	2,000	7	Cistern size:	15,000 gallons
Occupancy:	2 persons	Total:	2,000		Occupancy:	2 persons	Total:	2,000		Occupancy:	2 persons
Usage rate:	40 gpcd				Usage rate:	40 gpcd				Usage rate:	40 gpcd
Daily use:	80 gpd				Daily use:	80 gpd				Daily use:	80 gpd
System Size & Water Use		Backup Water Required		System Size & Water Use		Backup Water Required		System Size & Water Use		Backup Water Required	
Rootprint:	2,500 sq. ft.	Year	Amount (gallons)	% of total usage	Rootprint:	2,500 sq. ft.	Year	Amount (gallons)	% of total usage	Rootprint:	2,500 sq. ft.
Cistern size:	15,000 gallons	2008	6,000	18	Cistern size:	15,000 gallons	2008	6,000	18	Cistern size:	15,000 gallons
Curtailment vol:	3,000 gallons	2009	2,000	6	Curtailment vol:	3,000 gallons	2009	2,000	6	Curtailment vol:	3,000 gallons
Curtailment rate:	0.7 + irr.	2011	6,000	17	Curtailment rate:	0.7 + irr.	2011	6,000	17	Curtailment rate:	0.7 + irr.
Occupancy:	2 persons	Total:	14,000		Occupancy:	2 persons	Total:	14,000		Occupancy:	2 persons
Usage rate:	50 gpcd				Usage rate:	50 gpcd				Usage rate:	50 gpcd
Daily use:	100 gpd				Daily use:	100 gpd				Daily use:	100 gpd

San Marcos Rainwater Harvesting Model Summary Interior Use Only				San Marcos Rainwater Harvesting Model Summary Interior Use & Irrigation				San Marcos Rainwater Harvesting Model Summary Interior Use & Irrigation with Wastewater Reuse			
House with 2 person occupancy				House with 2 person occupancy, 1200 sq. ft. irrigated area				House with 2 person occupancy, 1200 sq. ft. irrigated area			
System Size & Water Use		Backup Water Required		System Size & Water Use		Backup Water Required		System Size & Water Use		Backup Water Required	
Rootprint:	3,000 sq. ft.	Year	Amount (gallons)	% of total usage	Rootprint:	3,000 sq. ft.	Year	Amount (gallons)	% of total usage	Rootprint:	3,000 sq. ft.
Cistern size:	15,000 gallons	2008	2,000	5	Cistern size:	15,000 gallons	2008	2,000	5	Cistern size:	15,000 gallons
Occupancy:	2 persons	2009	4,000	11	Occupancy:	2 persons	2009	4,000	11	Occupancy:	2 persons
Usage rate:	50 gpcd	2011	4,000	11	Usage rate:	50 gpcd	2011	4,000	11	Usage rate:	50 gpcd
Daily use:	100 gpd	Total:	10,000		Daily use:	100 gpd	Total:	10,000		Daily use:	100 gpd
System Size & Water Use		Backup Water Required		System Size & Water Use		Backup Water Required		System Size & Water Use		Backup Water Required	
Rootprint:	3,000 sq. ft.	Year	Amount (gallons)	% of total usage	Rootprint:	3,000 sq. ft.	Year	Amount (gallons)	% of total usage	Rootprint:	3,000 sq. ft.
Cistern size:	15,000 gallons	NONE required			Cistern size:	15,000 gallons	NONE required			Cistern size:	15,000 gallons
Occupancy:	2 persons				Occupancy:	2 persons				Occupancy:	2 persons
Usage rate:	45 gpcd				Usage rate:	45 gpcd				Usage rate:	45 gpcd
Daily use:	90 gpd				Daily use:	90 gpd				Daily use:	90 gpd
System Size & Water Use		Backup Water Required		System Size & Water Use		Backup Water Required		System Size & Water Use		Backup Water Required	
Rootprint:	3,000 sq. ft.	Year	Amount (gallons)	% of total usage	Rootprint:	3,000 sq. ft.	Year	Amount (gallons)	% of total usage	Rootprint:	3,000 sq. ft.
Cistern size:	15,000 gallons	NONE required			Cistern size:	15,000 gallons	NONE required			Cistern size:	15,000 gallons
Occupancy:	2 persons				Occupancy:	2 persons				Occupancy:	2 persons
Usage rate:	40 gpcd				Usage rate:	40 gpcd				Usage rate:	40 gpcd
Daily use:	80 gpd				Daily use:	80 gpd				Daily use:	80 gpd
System Size & Water Use		Backup Water Required		System Size & Water Use		Backup Water Required		System Size & Water Use		Backup Water Required	
Rootprint:	3,000 sq. ft.	Year	Amount (gallons)	% of total usage	Rootprint:	3,000 sq. ft.	Year	Amount (gallons)	% of total usage	Rootprint:	3,000 sq. ft.
Cistern size:	15,000 gallons	2008	2,000	5	Cistern size:	15,000 gallons	2008	2,000	5	Cistern size:	15,000 gallons
Curtailment vol:	3,000 gallons	2009	4,000	11	Curtailment vol:	3,000 gallons	2009	4,000	11	Curtailment vol:	3,000 gallons
Curtailment rate:	0.7 + irr.	2011	2,000	6	Curtailment rate:	0.7 + irr.	2011	2,000	6	Curtailment rate:	0.7 + irr.
Occupancy:	2 persons	Total:	8,000		Occupancy:	2 persons	Total:	8,000		Occupancy:	2 persons
Usage rate:	50 gpcd				Usage rate:	50 gpcd				Usage rate:	50 gpcd
Daily use:	100 gpd				Daily use:	100 gpd				Daily use:	100 gpd

San Marcos Rainwater Harvesting Model Summary
Interior Use Only

System Size & Water Use		Backup Water Required		
		Year	Amount (gallons)	% of total usage
House with 2.5 person occupancy				
Roofprint:	3,500 sq. ft.			
Cistern size:	20,000 gallons	2008	4,000	9
		2009	4,000	9
Occupancy:	2.5 persons	2011	4,000	9
Usage rate:	50 gpcd	Total:	12,000	
Daily use:	125 gpd			
System Size & Water Use		Backup Water Required		
Roofprint:	3,500 sq. ft.	2009	2,000	5
Cistern size:	20,000 gallons	Total:	2,000	
Occupancy:	2.5 persons			
Usage rate:	45 gpcd			
Daily use:	112.5 gpd			
System Size & Water Use		Backup Water Required		
Roofprint:	3,500 sq. ft.	NONE required		
Cistern size:	20,000 gallons			
Occupancy:	2.5 persons			
Usage rate:	40 gpcd			
Daily use:	100 gpd			
System Size & Water Use		Backup Water Required		
Roofprint:	3,500 sq. ft.	2008	4,000	9
Cistern size:	20,000 gallons	2009	2,000	5
Curtailment vol:	3,750 gallons	2011	2,000	5
Curtailment rate:	0.7 + irr.	Total:	8,000	
Occupancy:	2.5 persons			
Usage rate:	50 gpcd			
Daily use:	125 gpd			

San Marcos Rainwater Harvesting Model Summary
Interior Use & Irrigation

System Size & Water Use		Backup Water Required		
		Year	Amount (gallons)	% of total usage
House with 2.5 person occupancy, 1500 sq. ft. irrigated area				
Roofprint:	3,500 sq. ft.			
Cistern size:	20,000 gallons	Backup water required in 10 years		
		Max yr. =	28,000 in	2008
Occupancy:	2.5 persons	2nd most =	26,000 in	2011
Usage rate:	40 gpcd	Total req. =	122,000	gallons
Daily use:	100 gpd			
System Size & Water Use		Backup Water Required		
Roofprint:	3,500 sq. ft.	2009	2,000	5
Cistern size:	20,000 gallons	Total:	2,000	
Occupancy:	2.5 persons			
Usage rate:	45 gpcd			
Daily use:	112.5 gpd			
System Size & Water Use		Backup Water Required		
Roofprint:	3,500 sq. ft.	Backup water required in 6 years		
Cistern size:	20,000 gallons	Max yr. =	16,000 in	2 years
Occupancy:	2.5 persons	2nd most =	12,000 in	2009
Usage rate:	40 gpcd	Total req. =	56,000	gallons
Daily use:	100 gpd			
System Size & Water Use		Backup Water Required		
Roofprint:	3,500 sq. ft.	NONE required		
Cistern size:	20,000 gallons			
Occupancy:	2.5 persons			
Usage rate:	40 gpcd			
Daily use:	100 gpd			
System Size & Water Use		Backup Water Required		
Roofprint:	3,500 sq. ft.	2008	4,000	9
Cistern size:	20,000 gallons	2009	2,000	5
Curtailment vol:	3,750 gallons	2011	2,000	5
Curtailment rate:	0.7 + irr.	Total:	8,000	
Occupancy:	2.5 persons			
Usage rate:	50 gpcd			
Daily use:	125 gpd			

San Marcos Rainwater Harvesting Model Summary
Interior Use & Irrigation with Wastewater Reuse

System Size & Water Use		Backup Water Required		
		Year	Amount (gallons)	% of total usage
House with 2.5 person occupancy, 1500 sq. ft. irrigated area				
Roofprint:	3,500 sq. ft.			
Cistern size:	20,000 gallons	Backup water required in 10 years		
		Max yr. =	28,000 in	2008
Occupancy:	2.5 persons	2nd most =	26,000 in	2011
Usage rate:	40 gpcd	Total req. =	122,000	gallons
Daily use:	100 gpd			
System Size & Water Use		Backup Water Required		
Roofprint:	3,500 sq. ft.	2009	2,000	5
Cistern size:	20,000 gallons	Total:	2,000	
Occupancy:	2.5 persons			
Usage rate:	45 gpcd			
Daily use:	112.5 gpd			
System Size & Water Use		Backup Water Required		
Roofprint:	3,500 sq. ft.	NONE required		
Cistern size:	20,000 gallons			
Occupancy:	2.5 persons			
Usage rate:	40 gpcd			
Daily use:	100 gpd			
System Size & Water Use		Backup Water Required		
Roofprint:	3,500 sq. ft.	2008	4,000	9
Cistern size:	20,000 gallons	2009	2,000	5
Curtailment vol:	3,750 gallons	2011	2,000	5
Curtailment rate:	0.7 + irr.	Total:	8,000	
Occupancy:	2.5 persons			
Usage rate:	50 gpcd			
Daily use:	125 gpd			

San Marcos Rainwater Harvesting Model Summary
Interior Use Only

System Size & Water Use		Backup Water Required		
		Year	Amount (gallons)	% of total usage
House with 3 person occupancy				
Roofprint:	4,000 sq. ft.			
Cistern size:	20,000 gallons	1996	2,000	4
		2006	2,000	4
Occupancy:	3 persons	2008	8,000	15
Usage rate:	50 gpcd	2009	10,000	18
Daily use:	150 gpd	2011	10,000	18
		Total:	32,000	
System Size & Water Use		Backup Water Required		
Roofprint:	4,000 sq. ft.	2008	2,000	4
Cistern size:	20,000 gallons	2009	4,000	8
Occupancy:	3 persons	2011	4,000	8
Usage rate:	45 gpcd	Total:	10,000	
Daily use:	135 gpd			
System Size & Water Use		Backup Water Required		
Roofprint:	4,000 sq. ft.	NONE required		
Cistern size:	20,000 gallons			
Occupancy:	3 persons			
Usage rate:	40 gpcd			
Daily use:	120 gpd			
System Size & Water Use		Backup Water Required		
Roofprint:	4,000 sq. ft.	2008	6,000	12
Cistern size:	20,000 gallons	2009	4,000	8
Curtailment vol:	4,500 gallons	2011	4,000	9
Curtailment rate:	0.7 + irr.	Total:	14,000	
Occupancy:	3 persons			
Usage rate:	50 gpcd			
Daily use:	150 gpd			

San Marcos Rainwater Harvesting Model Summary
Interior Use & Irrigation

System Size & Water Use		Backup Water Required		
		Year	Amount (gallons)	% of total usage
House with 3 person occupancy, 1800 sq. ft. irrigated area				
Roofprint:	4,000 sq. ft.			
Cistern size:	20,000 gallons	Backup water required in 18 years		
		Max yr. =	38,000 in	2008
Occupancy:	3 persons	2nd most =	36,000 in	2011
Usage rate:	50 gpcd	Total req. =	200,000	gallons
Daily use:	150 gpd			
System Size & Water Use		Backup Water Required		
Roofprint:	4,000 sq. ft.	2008	2,000	4
Cistern size:	20,000 gallons	2009	4,000	8
Occupancy:	3 persons	2011	4,000	8
Usage rate:	45 gpcd	Total:	10,000	
Daily use:	135 gpd			
System Size & Water Use		Backup Water Required		
Roofprint:	4,000 sq. ft.	Backup water required in 14 years		
Cistern size:	20,000 gallons	Max yr. =	32,000 in	2008
Occupancy:	3 persons	2nd most =	30,000 in	2011
Usage rate:	45 gpcd	Total req. =	150,000	gallons
Daily use:	135 gpd			
System Size & Water Use		Backup Water Required		
Roofprint:	4,000 sq. ft.	Backup water required in 11 years		
Cistern size:	20,000 gallons	Max yr. =	26,000 in	2 years
Occupancy:	3 persons	2nd most =	16,000 in	2009
Usage rate:	40 gpcd	Total req. =	102,000	gallons
Daily use:	120 gpd			
System Size & Water Use		Backup Water Required		
Roofprint:	4,000 sq. ft.	2008	2,000	4
Cistern size:	20,000 gallons	2009	4,000	8
Curtailment vol:	4,500 gallons	2011	4,000	8
Curtailment rate:	0.7 + irr.	Total:	10,000	
Occupancy:	3 persons			
Usage rate:	50 gpcd			
Daily use:	150 gpd			

San Marcos Rainwater Harvesting Model Summary
Interior Use & Irrigation with Wastewater Reuse

System Size & Water Use		Backup Water Required		
		Year	Amount (gallons)	% of total usage
House with 3 person occupancy, 1800 sq. ft. irrigated area				
Roofprint:	4,000 sq. ft.			
Cistern size:	20,000 gallons	Backup water required in 18 years		
		Max yr. =	38,000 in	2008
Occupancy:	3 persons	2nd most =	36,000 in	2011
Usage rate:	50 gpcd	Total req. =	200,000	gallons
Daily use:	150 gpd			
System Size & Water Use		Backup Water Required		
Roofprint:	4,000 sq. ft.	1999	2,000	4
Cistern size:	20,000 gallons	2006	2,000	4
Occupancy:	3 persons	2008	8,000	15
Usage rate:	50 gpcd	2009	10,000	18
Daily use:	150 gpd	2011	12,000	18
		Total:	36,000	21
System Size & Water Use		Backup Water Required		
Roofprint:	4,000 sq. ft.	2008	4,000	8
Cistern size:	20,000 gallons	2009	8,000	15
Occupancy:	3 persons	2011	6,000	11
Usage rate:	45 gpcd	Total:	18,000	
Daily use:	135 gpd			
System Size & Water Use		Backup Water Required		
Roofprint:	4,000 sq. ft.	Backup water required in 16 years		
Cistern size:	20,000 gallons	Max yr. =	12,000 in	2 years
Occupancy:	3 persons	2nd most =	10,000 in	2006
Usage rate:	45 gpcd	Total req. =	82,000	gallons
Daily use:	150 gpd			
System Size & Water Use		Backup Water Required		
Roofprint:	4,000 sq. ft.	2009	4,000	8
Cistern size:	20,000 gallons	2011	4,000	8
Occupancy:	3 persons	Total:	8,000	
Usage rate:	40 gpcd			
Daily use:	120 gpd			
System Size & Water Use		Backup Water Required		
Roofprint:	4,000 sq. ft.	1999	2,000	4
Cistern size:	20,000 gallons	2008	6,000	12
Curtailment vol:	4,500 gallons	2009	4,000	8
Curtailment rate:	0.7 + irr.	2011	6,000	12
Occupancy:	3 persons	Total:	18,000	
Usage rate:	50 gpcd			
Daily use:	150 gpd			

San Marcos Rainwater Harvesting Model Summary
Interior Use Only

House with 3 person occupancy		Backup Water Required		
System Size & Water Use		Year	Amount (gallons)	% of total usage
Roofprint:	4,000 sq. ft.			
Cistern size:	25,000 gallons	2008	4,000	7
		2009	8,000	15
Occupancy:	3 persons	2011	4,000	7
Usage rate:	50 gpcd	Total:	16,000	
Daily use:	150 gpd			

System Size & Water Use		Year	Amount (gallons)	% of total usage
Roofprint:	4,000 sq. ft.			
Cistern size:	25,000 gallons	2009	2,000	4
Occupancy:	3 persons	Total:	2,000	
Usage rate:	45 gpcd			
Daily use:	135 gpd			

System Size & Water Use		Year	Amount (gallons)	% of total usage
Roofprint:	4,000 sq. ft.			
Cistern size:	25,000 gallons	NONE required		
Occupancy:	3 persons			
Usage rate:	40 gpcd			
Daily use:	120 gpd			

System Size & Water Use		Year	Amount (gallons)	% of total usage
Roofprint:	4,000 sq. ft.			
Cistern size:	25,000 gallons	2008	4,000	7
Curtailment vol:	4,500 gallons	2009	4,000	8
Curtailment rate:	0.7 + irr.	2011	2,000	4
Occupancy:	3 persons	Total:	10,000	
Usage rate:	50 gpcd			
Daily use:	150 gpd			

San Marcos Rainwater Harvesting Model Summary
Interior Use & Irrigation

House with 3 person occupancy, 1800 sq. ft. irrigated area		Backup Water Required		
System Size & Water Use		Year	Amount (gallons)	% of total usage
Roofprint:	4,000 sq. ft.			
Cistern size:	25,000 gallons	Backup water required in 11 years		
		Max yr. =	36,000 in	2008
Occupancy:	3 persons	2nd most =	32,000 in	2011
Usage rate:	50 gpcd	Total req. =	154,000 gallons	
Daily use:	150 gpd			

System Size & Water Use		Year	Amount (gallons)	% of total usage
Roofprint:	4,000 sq. ft.			
Cistern size:	25,000 gallons	Backup water required in 10 years		
		Max yr. =	28,000 in	2008
Occupancy:	3 persons	2nd most =	26,000 in	2011
Usage rate:	45 gpcd	Total req. =	110,000 gallons	
Daily use:	135 gpd			

System Size & Water Use		Year	Amount (gallons)	% of total usage
Roofprint:	4,000 sq. ft.			
Cistern size:	25,000 gallons	Backup water required in 6 years		
		Max yr. =	20,000 in	2 years
Occupancy:	3 persons	2nd most =	16,000 in	2009
Usage rate:	40 gpcd	Total req. =	68,000 gallons	
Daily use:	120 gpd			

System Size & Water Use		Year	Amount (gallons)	% of total usage
Roofprint:	4,000 sq. ft.			
Cistern size:	25,000 gallons	Backup water required in 10 years		
		Max yr. =	12,000 in	2008
Occupancy:	3 persons	2nd most =	10,000 in	2 years
Usage rate:	50 gpcd	Total req. =	64,000 gallons	
Daily use:	150 gpd			

San Marcos Rainwater Harvesting Model Summary
Interior Use & Irrigation with Wastewater Reuse

House with 3 person occupancy, 1800 sq. ft. irrigated area		Backup Water Required		
System Size & Water Use		Year	Amount (gallons)	% of total usage
Roofprint:	4,000 sq. ft.			
Cistern size:	25,000 gallons	2008	4,000	7
		2009	10,000	18
Occupancy:	3 persons	2011	6,000	11
Usage rate:	50 gpcd	Total:	20,000	
Daily use:	150 gpd			

System Size & Water Use		Year	Amount (gallons)	% of total usage
Roofprint:	4,000 sq. ft.			
Cistern size:	25,000 gallons	2009	6,000	11
		2011	2,000	4
Occupancy:	3 persons	Total:	8,000	
Usage rate:	45 gpcd			
Daily use:	135 gpd			

System Size & Water Use		Year	Amount (gallons)	% of total usage
Roofprint:	4,000 sq. ft.			
Cistern size:	25,000 gallons	NONE required		
Occupancy:	3 persons			
Usage rate:	40 gpcd			
Daily use:	120 gpd			

System Size & Water Use		Year	Amount (gallons)	% of total usage
Roofprint:	4,000 sq. ft.			
Cistern size:	25,000 gallons	Backup water required in 10 years		
		Max yr. =	12,000 in	2008
Occupancy:	3 persons	2nd most =	10,000 in	2 years
Usage rate:	50 gpcd	Total req. =	64,000 gallons	
Daily use:	150 gpd			

San Marcos Rainwater Harvesting Model Summary
Interior Use Only

House with 4 person occupancy		Backup Water Required		
System Size & Water Use		Year	Amount (gallons)	% of total usage
Roofprint:	4,500 sq. ft.			
Cistern size:	30,000 gallons	1989	2,000	3
		1990	2,000	3
Occupancy:	4 persons	1996	2,000	3
Usage rate:	50 gpcd	2006	4,000	5
Daily use:	200 gpd	2008	18,000	25
		2009	16,000	22
		2011	14,000	19
		Total:	58,000	

System Size & Water Use		Year	Amount (gallons)	% of total usage
Roofprint:	4,500 sq. ft.			
Cistern size:	30,000 gallons	2008	8,000	12
		2009	12,000	18
Occupancy:	4 persons	2011	8,000	12
Usage rate:	45 gpcd	Total:	28,000	
Daily use:	180 gpd			

System Size & Water Use		Year	Amount (gallons)	% of total usage
Roofprint:	4,500 sq. ft.			
Cistern size:	30,000 gallons	2009	6,000	10
Occupancy:	4 persons	Total:	6,000	
Usage rate:	40 gpcd			
Daily use:	160 gpd			

System Size & Water Use		Year	Amount (gallons)	% of total usage
Roofprint:	4,500 sq. ft.			
Cistern size:	30,000 gallons	Backup water required in 15 years		
		Max yr. =	40,000 in	2008
Occupancy:	4 persons	2nd most =	42,000 in	2011
Usage rate:	45 gpcd	Total req. =	250,000 gallons	
Daily use:	180 gpd			

San Marcos Rainwater Harvesting Model Summary
Interior Use & Irrigation

House with 4 person occupancy, 2400 sq. ft. irrigated area		Backup Water Required		
System Size & Water Use		Year	Amount (gallons)	% of total usage
Roofprint:	4,500 sq. ft.			
Cistern size:	30,000 gallons	Backup water required in 19 years		
		Max yr. =	58,000 in	2008
Occupancy:	4 persons	2nd most =	52,000 in	2011
Usage rate:	50 gpcd	Total req. =	352,000 gallons	
Daily use:	200 gpd			

System Size & Water Use		Year	Amount (gallons)	% of total usage
Roofprint:	4,500 sq. ft.			
Cistern size:	30,000 gallons	Backup water required in 15 years		
		Max yr. =	50,000 in	2008
Occupancy:	4 persons	2nd most =	42,000 in	2011
Usage rate:	45 gpcd	Total req. =	250,000 gallons	
Daily use:	180 gpd			

System Size & Water Use		Year	Amount (gallons)	% of total usage
Roofprint:	4,500 sq. ft.			
Cistern size:	30,000 gallons	Backup water required in 11 years		
		Max yr. =	40,000 in	2008
Occupancy:	4 persons	2nd most =	34,000 in	2011
Usage rate:	40 gpcd	Total req. =	174,000 gallons	
Daily use:	160 gpd			

System Size & Water Use		Year	Amount (gallons)	% of total usage
Roofprint:	4,500 sq. ft.			
Cistern size:	30,000 gallons	Backup water required in 15 years		
		Max yr. =	16,000 in	2008
Occupancy:	4 persons	2nd most =	10,000 in	2 years
Usage rate:	50 gpcd	Total req. =	98,000 gallons	
Daily use:	200 gpd			

San Marcos Rainwater Harvesting Model Summary
Interior Use & Irrigation with Wastewater Reuse

House with 4 person occupancy, 2400 sq. ft. irrigated area		Backup Water Required		
System Size & Water Use		Year	Amount (gallons)	% of total usage
Roofprint:	4,500 sq. ft.			
Cistern size:	30,000 gallons	1989	4,000	5
		1990	2,000	3
Occupancy:	4 persons	1996	2,000	3
Usage rate:	50 gpcd	2006	6,000	8
Daily use:	200 gpd	2008	20,000	27
		2009	18,000	24
		2011	18,000	24
		Total:	70,000	

System Size & Water Use		Year	Amount (gallons)	% of total usage
Roofprint:	4,500 sq. ft.			
Cistern size:	30,000 gallons	2008	10,000	15
		2009	16,000	23
Occupancy:	4 persons	2011	12,000	17
Usage rate:	45 gpcd	Total:	38,000	
Daily use:	180 gpd			

System Size & Water Use		Year	Amount (gallons)	% of total usage
Roofprint:	4,500 sq. ft.			
Cistern size:	30,000 gallons	2008	4,000	6
		2009	10,000	16
Occupancy:	4 persons	2011	6,000	9
Usage rate:	40 gpcd	Total:	20,000	
Daily use:	160 gpd			

System Size & Water Use		Year	Amount (gallons)	% of total usage
Roofprint:	4,500 sq. ft.			
Cistern size:	30,000 gallons	Backup water required in 15 years		
		Max yr. =	16,000 in	2008
Occupancy:	4 persons	2nd most =	10,000 in	2 years
Usage rate:	50 gpcd	Total req. =	98,000 gallons	
Daily use:	200 gpd			

San Marcos Rainwater Harvesting Model Summary
Interior Use Only

House with 4 person occupancy		Backup Water Required		
System Size & Water Use		Year	Amount (gallons)	% of total usage
Roofprint:	4,500 sq. ft.	2008	14,000	19
Cistern size:	35,000 gallons	2009	14,000	19
Occupancy:	4 persons	2011	10,000	14
Usage rate:	50 gpcd	Total:	38,000	
Daily use:	200 gpd			

System Size & Water Use		Backup Water Required		
System Size & Water Use		Year	Amount (gallons)	% of total usage
Roofprint:	4,500 sq. ft.	2008	4,000	6
Cistern size:	35,000 gallons	2009	10,000	15
Occupancy:	4 persons	2011	2,000	3
Usage rate:	45 gpcd	Total:	16,000	
Daily use:	180 gpd			

System Size & Water Use		Backup Water Required		
System Size & Water Use		Year	Amount (gallons)	% of total usage
Roofprint:	4,500 sq. ft.	NONE required		
Cistern size:	35,000 gallons			
Occupancy:	4 persons			
Usage rate:	40 gpcd			
Daily use:	160 gpd			

System Size & Water Use		Backup Water Required		
System Size & Water Use		Year	Amount (gallons)	% of total usage
Roofprint:	4,500 sq. ft.	2008	4,000	6
Cistern size:	35,000 gallons	2009	6,000	10
Curtailment vol:	6,000 gallons	2011	4,000	6
Occupancy:	4 persons	Total:	14,000	
Usage rate:	50 gpcd			
Daily use:	200 gpd			

San Marcos Rainwater Harvesting Model Summary
Interior Use & Irrigation

House with 4 person occupancy, 2400 sq. ft. irrigated area		Backup Water Required		
System Size & Water Use		Year	Amount (gallons)	% of total usage
Roofprint:	4,500 sq. ft.	Backup water required in 15 years		
Cistern size:	35,000 gallons	Max yr. =	56,000 in	2008
Occupancy:	4 persons	2nd most =	48,000 in	2011
Usage rate:	50 gpcd	Total req. =	314,000 gallons	
Daily use:	200 gpd			

System Size & Water Use		Backup Water Required		
System Size & Water Use		Year	Amount (gallons)	% of total usage
Roofprint:	4,500 sq. ft.	Backup water required in 13 years		
Cistern size:	35,000 gallons	Max yr. =	46,000 in	2008
Occupancy:	4 persons	2nd most =	38,000 in	2011
Usage rate:	45 gpcd	Total req. =	214,000 gallons	
Daily use:	180 gpd			

System Size & Water Use		Backup Water Required		
System Size & Water Use		Year	Amount (gallons)	% of total usage
Roofprint:	4,500 sq. ft.	Backup water required in 9 years		
Cistern size:	35,000 gallons	Max yr. =	36,000 in	2008
Occupancy:	4 persons	2nd most =	30,000 in	2011
Usage rate:	40 gpcd	Total req. =	142,000 gallons	
Daily use:	160 gpd			

System Size & Water Use		Backup Water Required		
System Size & Water Use		Year	Amount (gallons)	% of total usage
Roofprint:	4,500 sq. ft.	Backup water required in 12 years		
Cistern size:	35,000 gallons	Max yr. =	22,000 in	2008
Curtailment vol:	6,000 gallons	2nd most =	12,000 in	2 years
Occupancy:	4 persons	Total req. =	92,000 gallons	
Usage rate:	50 gpcd			
Daily use:	200 gpd			

San Marcos Rainwater Harvesting Model Summary
Interior Use & Irrigation with Wastewater Reuse

House with 4 person occupancy, 2400 sq. ft. irrigated area		Backup Water Required		
System Size & Water Use		Year	Amount (gallons)	% of total usage
Roofprint:	4,500 sq. ft.	1989	2,000	3
Cistern size:	35,000 gallons	2006	2,000	3
Occupancy:	4 persons	2008	14,000	19
Usage rate:	50 gpcd	2009	18,000	24
Daily use:	200 gpd	2011	12,000	16
		Total:	48,000	

System Size & Water Use		Backup Water Required		
System Size & Water Use		Year	Amount (gallons)	% of total usage
Roofprint:	4,500 sq. ft.	2008	6,000	9
Cistern size:	35,000 gallons	2009	14,000	20
Occupancy:	4 persons	2011	6,000	9
Usage rate:	45 gpcd	Total:	26,000	
Daily use:	180 gpd			

System Size & Water Use		Backup Water Required		
System Size & Water Use		Year	Amount (gallons)	% of total usage
Roofprint:	4,500 sq. ft.	NONE required		
Cistern size:	35,000 gallons			
Occupancy:	4 persons			
Usage rate:	40 gpcd			
Daily use:	160 gpd			

System Size & Water Use		Backup Water Required		
System Size & Water Use		Year	Amount (gallons)	% of total usage
Roofprint:	4,500 sq. ft.	1989	2,000	3
Cistern size:	35,000 gallons	2008	6,000	9
Curtailment vol:	6,000 gallons	2009	8,000	13
Occupancy:	4 persons	2011	6,000	9
Usage rate:	50 gpcd	Total:	22,000	
Daily use:	200 gpd			

San Marcos Rainwater Harvesting Model Summary
Interior Use Only

House with 4 person occupancy		Backup Water Required		
System Size & Water Use		Year	Amount (gallons)	% of total usage
Roofprint:	4,500 sq. ft.	2008	8,000	11
Cistern size:	40,000 gallons	2009	16,000	22
Occupancy:	4 persons	2011	6,000	8
Usage rate:	50 gpcd	Total:	30,000	
Daily use:	200 gpd			

System Size & Water Use		Backup Water Required		
System Size & Water Use		Year	Amount (gallons)	% of total usage
Roofprint:	4,500 sq. ft.	NONE required		
Cistern size:	40,000 gallons			
Occupancy:	4 persons			
Usage rate:	40 gpcd			
Daily use:	160 gpd			

System Size & Water Use		Backup Water Required		
System Size & Water Use		Year	Amount (gallons)	% of total usage
Roofprint:	4,500 sq. ft.	2008	4,000	6
Cistern size:	40,000 gallons	2009	6,000	10
Curtailment vol:	6,000 gallons	2011	2,000	3
Occupancy:	4 persons	Total:	12,000	
Usage rate:	50 gpcd			
Daily use:	200 gpd			

San Marcos Rainwater Harvesting Model Summary
Interior Use & Irrigation

House with 4 person occupancy, 2400 sq. ft. irrigated area		Backup Water Required		
System Size & Water Use		Year	Amount (gallons)	% of total usage
Roofprint:	4,500 sq. ft.	Backup water required in 15 years		
Cistern size:	40,000 gallons	Max yr. =	50,000 in	2008
Occupancy:	4 persons	2nd most =	44,000 in	2011
Usage rate:	50 gpcd	Total req. =	274,000 gallons	
Daily use:	200 gpd			

System Size & Water Use		Backup Water Required		
System Size & Water Use		Year	Amount (gallons)	% of total usage
Roofprint:	4,500 sq. ft.	Backup water required in 9 years		
Cistern size:	40,000 gallons	Max yr. =	40,000 in	2008
Occupancy:	4 persons	2nd most =	32,000 in	2 years
Usage rate:	45 gpcd	Total req. =	176,000 gallons	
Daily use:	180 gpd			

System Size & Water Use		Backup Water Required		
System Size & Water Use		Year	Amount (gallons)	% of total usage
Roofprint:	4,500 sq. ft.	Backup water required in 7 years		
Cistern size:	40,000 gallons	Max yr. =	30,000 in	2008
Occupancy:	4 persons	2nd most =	28,000 in	2009
Usage rate:	40 gpcd	Total req. =	118,000 gallons	
Daily use:	160 gpd			

System Size & Water Use		Backup Water Required		
System Size & Water Use		Year	Amount (gallons)	% of total usage
Roofprint:	4,500 sq. ft.	Backup water required in 12 years		
Cistern size:	40,000 gallons	Max yr. =	20,000 in	2008
Curtailment vol:	6,000 gallons	2nd most =	16,000 in	2011
Occupancy:	4 persons	Total req. =	86,000 gallons	
Usage rate:	50 gpcd			
Daily use:	200 gpd			

San Marcos Rainwater Harvesting Model Summary
Interior Use & Irrigation with Wastewater Reuse

House with 4 person occupancy, 2400 sq. ft. irrigated area		Backup Water Required		
System Size & Water Use		Year	Amount (gallons)	% of total usage
Roofprint:	4,500 sq. ft.	2008	10,000	13
Cistern size:	40,000 gallons	2009	18,000	24
Occupancy:	4 persons	2011	8,000	11
Usage rate:	50 gpcd	Total:	36,000	
Daily use:	200 gpd			

System Size & Water Use		Backup Water Required		
System Size & Water Use		Year	Amount (gallons)	% of total usage
Roofprint:	4,500 sq. ft.	2008	2,000	3
Cistern size:	40,000 gallons	2009	14,000	20
Occupancy:	4 persons	2011	2,000	3
Usage rate:	45 gpcd	Total:	18,000	
Daily use:	180 gpd			

System Size & Water Use		Backup Water Required		
System Size & Water Use		Year	Amount (gallons)	% of total usage
Roofprint:	4,500 sq. ft.	NONE required		
Cistern size:	40,000 gallons			
Occupancy:	4 persons			
Usage rate:	40 gpcd			
Daily use:	160 gpd			

System Size & Water Use		Backup Water Required		
System Size & Water Use		Year	Amount (gallons)	% of total usage
Roofprint:	4,500 sq. ft.	2009	4,000	6
Cistern size:	40,000 gallons			
Occupancy:	4 persons	Total:	4,000	
Usage rate:	40 gpcd			
Daily use:	160 gpd			

San Marcos Rainwater Harvesting Model Summary
Interior Use Only

System Size & Water Use		Backup Water Required		
		Year	Amount (gallons)	% of total usage
Roofprint:	5,500 sq. ft.			
Cistern size:	45,000 gallons	2008	12,000	14
		2009	18,000	21
		2011	6,000	7
Occupancy:	4 persons	Total:	36,000	
Usage rate:	60 gpcd			
Daily use:	240 gpd			

System Size & Water Use		Backup Water Required		
		Year	Amount (gallons)	% of total usage
Roofprint:	5,500 sq. ft.			
Cistern size:	45,000 gallons	2009	4,000	5
Curtailment vol:	7,200 gallons	2009	6,000	8
Curtailment rate:	0.7 + irr.	2011	2,000	3
Occupancy:	4 persons	Total:	12,000	
Usage rate:	60 gpcd			
Daily use:	240 gpd			

System Size & Water Use		Backup Water Required		
		Year	Amount (gallons)	% of total usage
Roofprint:	6,000 sq. ft.			
Cistern size:	50,000 gallons	2008	2,000	2
		2009	12,000	14
Occupancy:	4 persons	Total:	14,000	
Usage rate:	60 gpcd			
Daily use:	240 gpd			

System Size & Water Use		Backup Water Required		
		Year	Amount (gallons)	% of total usage
Roofprint:	6,000 sq. ft.			
Cistern size:	50,000 gallons	2009	4,000	5
Curtailment vol:	7,200 gallons	Total:	4,000	
Curtailment rate:	0.7 + irr.			
Occupancy:	4 persons			
Usage rate:	60 gpcd			
Daily use:	240 gpd			

San Marcos Rainwater Harvesting Model Summary
Interior Use & Irrigation

System Size & Water Use		Backup Water Required		
		Year	Amount (gallons)	% of total usage
Roofprint:	5,500 sq. ft.			
Cistern size:	45,000 gallons			
Occupancy:	4 persons			
Usage rate:	45 gpcd			
Daily use:	180 gpd			

System Size & Water Use		Backup Water Required		
		Year	Amount (gallons)	% of total usage
Roofprint:	5,500 sq. ft.			
Cistern size:	45,000 gallons			
Curtailment vol:	7,200 gallons			
Curtailment rate:	0.7 + irr.			
Occupancy:	4 persons			
Usage rate:	60 gpcd			
Daily use:	240 gpd			

System Size & Water Use		Backup Water Required		
		Year	Amount (gallons)	% of total usage
Roofprint:	6,000 sq. ft.			
Cistern size:	50,000 gallons			
Occupancy:	4 persons			
Usage rate:	60 gpcd			
Daily use:	240 gpd			

System Size & Water Use		Backup Water Required		
		Year	Amount (gallons)	% of total usage
Roofprint:	6,000 sq. ft.			
Cistern size:	50,000 gallons			
Curtailment vol:	7,200 gallons			
Curtailment rate:	0.7 + irr.			
Occupancy:	4 persons			
Usage rate:	60 gpcd			
Daily use:	240 gpd			

San Marcos Rainwater Harvesting Model Summary
Interior Use & Irrigation with Wastewater Reuse

System Size & Water Use		Backup Water Required		
		Year	Amount (gallons)	% of total usage
Roofprint:	5,500 sq. ft.			
Cistern size:	45,000 gallons	2008	12,000	14
		2009	18,000	20
		2011	8,000	9
Occupancy:	4 persons	Total:	38,000	
Usage rate:	45 gpcd			
Daily use:	180 gpd			

System Size & Water Use		Backup Water Required		
		Year	Amount (gallons)	% of total usage
Roofprint:	5,500 sq. ft.			
Cistern size:	45,000 gallons	2008	4,000	5
Curtailment vol:	7,200 gallons	2009	6,000	8
Curtailment rate:	0.7 + irr.	2011	2,000	3
Occupancy:	4 persons	Total:	12,000	
Usage rate:	60 gpcd			
Daily use:	240 gpd			

System Size & Water Use		Backup Water Required		
		Year	Amount (gallons)	% of total usage
Roofprint:	6,000 sq. ft.			
Cistern size:	50,000 gallons	2008	2,000	2
		2009	12,000	14
Occupancy:	4 persons	Total:	14,000	
Usage rate:	60 gpcd			
Daily use:	240 gpd			

System Size & Water Use		Backup Water Required		
		Year	Amount (gallons)	% of total usage
Roofprint:	6,000 sq. ft.			
Cistern size:	50,000 gallons	2009	4,000	5
Curtailment vol:	7,200 gallons	Total:	4,000	
Curtailment rate:	0.7 + irr.			
Occupancy:	4 persons			
Usage rate:	60 gpcd			
Daily use:	240 gpd			

Requirements for house with 4 person occupancy, 2,400 sq. ft. irrigated area with no wastewater irrigation

System Size & Water Use		Backup Water Required			System Size & Water Use		Backup Water Required			System Size & Water Use		Backup Water Required		
		Year	Amount (gallons)	% of total usage			Year	Amount (gallons)	% of total usage			Year	Amount (gallons)	% of total usage
Roofprint:	7,000 sq. ft.				Roofprint:	7,000 sq. ft.				Roofprint:	7,000 sq. ft.			
Cistern size:	55,000 gallons	2008	4,000	4	Cistern size:	55,000 gallons	2009	8,000	9	Cistern size:	55,000 gallons	NONE	required	
		2009	20,000	21										
		2011	6,000	6	Occupancy:	4 persons	Total:	8,000		Occupancy:	4 persons			
Occupancy:	4 persons	Total:	30,000		Usage rate:	45 gpcd				Usage rate:	40 gpcd			
Usage rate:	50 gpcd				Daily use:	180 gpd				Daily use:	160 gpd			
Daily use:	200 gpd													

System Size & Water Use		Backup Water Required			System Size & Water Use		Backup Water Required			System Size & Water Use		Backup Water Required		
		Year	Amount (gallons)	% of total usage			Year	Amount (gallons)	% of total usage			Year	Amount (gallons)	% of total usage
Roofprint:	7,000 sq. ft.				Roofprint:	7,000 sq. ft.				Roofprint:	7,000 sq. ft.			
Cistern size:	55,000 gallons	2008	4,000	4	Cistern size:	55,000 gallons	2009	4,000	5	Cistern size:	55,000 gallons	NONE	required	
		2009	10,000	12										
		2011	2,000	2	Curtailment vol:	6,000 gallons	Total:	4,000		Curtailment vol:	6,000 gallons			
Occupancy:	4 persons	Total:	16,000		Curtailment rate:	1.0 irr. only				Curtailment rate:	1.0 irr. only			
Usage rate:	4 gpcd				Occupancy:	4 persons				Occupancy:	4 persons			
Daily use:	200 gpd				Usage rate:	45 gpcd				Usage rate:	40 gpcd			
					Daily use:	180 gpd				Daily use:	160 gpd			

Wimberley Rainwater Harvesting Model Summary
Interior Use Only

System Size & Water Use			Backup Water Required		
	Year	Amount (gallons)	% of total usage		
House with 2.5 person occupancy					
Roofprint: 3,500 sq. ft.					
Cistern size: 20,000 gallons	2009	2,000	4		
Occupancy: 2.5 persons	2011	8,000	18		
Usage rate: 50 gpcd	Total:	10,000			
Daily use: 125 gpd					
System Size & Water Use			Backup Water Required		
	Year	Amount (gallons)	% of total usage		
Roofprint: 3,500 sq. ft.					
Cistern size: 20,000 gallons	2011	4,000	10		
Occupancy: 2.5 persons	Total:	4,000			
Usage rate: 45 gpcd					
Daily use: 112.5 gpd					
System Size & Water Use			Backup Water Required		
	Year	Amount (gallons)	% of total usage		
Roofprint: 3,500 sq. ft.					
Cistern size: 20,000 gallons		NONE required			
Occupancy: 2.5 persons					
Usage rate: 40 gpcd					
Daily use: 100 gpd					
System Size & Water Use			Backup Water Required		
	Year	Amount (gallons)	% of total usage		
Roofprint: 3,500 sq. ft.					
Cistern size: 20,000 gallons	2011	6,000	15		
Curtailment vol: 3,750 gallons	Total:	6,000			
Curtailment rate: 0.7 + irr.					
Occupancy: 2.5 persons					
Usage rate: 50 gpcd					
Daily use: 125 gpd					

Wimberley Rainwater Harvesting Model Summary
Interior Use & Irrigation

System Size & Water Use			Backup Water Required		
	Year	Amount (gallons)	% of total usage		
House with 2.5 person occupancy, 1500 sq. ft. irrigated area					
Roofprint: 3,500 sq. ft.					
Cistern size: 20,000 gallons					
Occupancy: 2.5 persons					
Usage rate: 50 gpcd					
Daily use: 125 gpd					
System Size & Water Use			Backup Water Required		
	Year	Amount (gallons)	% of total usage		
Roofprint: 3,500 sq. ft.					
Cistern size: 20,000 gallons					
Occupancy: 2.5 persons					
Usage rate: 45 gpcd					
Daily use: 112.5 gpd					
System Size & Water Use			Backup Water Required		
	Year	Amount (gallons)	% of total usage		
Roofprint: 3,500 sq. ft.					
Cistern size: 20,000 gallons					
Occupancy: 2.5 persons					
Usage rate: 40 gpcd					
Daily use: 100 gpd					
System Size & Water Use			Backup Water Required		
	Year	Amount (gallons)	% of total usage		
Roofprint: 3,500 sq. ft.					
Cistern size: 20,000 gallons					
Occupancy: 2.5 persons					
Usage rate: 50 gpcd					
Daily use: 125 gpd					

Wimberley Rainwater Harvesting Model Summary
Interior Use & Irrigation with Wastewater Reuse

System Size & Water Use			Backup Water Required		
	Year	Amount (gallons)	% of total usage		
House with 2.5 person occupancy, 1500 sq. ft. irrigated area					
Roofprint: 3,500 sq. ft.					
Cistern size: 20,000 gallons	2009	4,000	8		
Occupancy: 2.5 persons	2011	10,000	21		
Usage rate: 50 gpcd	Total:	14,000			
Daily use: 125 gpd					
System Size & Water Use			Backup Water Required		
	Year	Amount (gallons)	% of total usage		
Roofprint: 3,500 sq. ft.					
Cistern size: 20,000 gallons	2011	6,000	14		
Occupancy: 2.5 persons	Total:	6,000			
Usage rate: 45 gpcd					
Daily use: 112.5 gpd					
System Size & Water Use			Backup Water Required		
	Year	Amount (gallons)	% of total usage		
Roofprint: 3,500 sq. ft.					
Cistern size: 20,000 gallons	2011	4,000	10		
Occupancy: 2.5 persons	Total:	4,000			
Usage rate: 40 gpcd					
Daily use: 100 gpd					
System Size & Water Use			Backup Water Required		
	Year	Amount (gallons)	% of total usage		
Roofprint: 3,500 sq. ft.					
Cistern size: 20,000 gallons	2009	4,000	9		
Curtailment vol: 3,750 gallons	2011	6,000	15		
Curtailment rate: 0.7 + irr.	Total:	10,000			
Occupancy: 2.5 persons					
Usage rate: 50 gpcd					
Daily use: 125 gpd					

Wimberley Rainwater Harvesting Model Summary
Interior Use Only

System Size & Water Use			Backup Water Required		
	Year	Amount (gallons)	% of total usage		
House with 3 person occupancy					
Roofprint: 4,000 sq. ft.					
Cistern size: 20,000 gallons	2008	2,000	4		
Occupancy: 3 persons	2009	6,000	11		
Usage rate: 50 gpcd	2011	14,000	28		
Daily use: 150 gpd	Total:	22,000			
System Size & Water Use			Backup Water Required		
	Year	Amount (gallons)	% of total usage		
Roofprint: 4,000 sq. ft.					
Cistern size: 20,000 gallons	2011	8,000	16		
Occupancy: 3 persons	Total:	8,000			
Usage rate: 45 gpcd					
Daily use: 135 gpd					
System Size & Water Use			Backup Water Required		
	Year	Amount (gallons)	% of total usage		
Roofprint: 4,000 sq. ft.					
Cistern size: 20,000 gallons	2011	4,000	9		
Occupancy: 3 persons	Total:	4,000			
Usage rate: 40 gpcd					
Daily use: 120 gpd					
System Size & Water Use			Backup Water Required		
	Year	Amount (gallons)	% of total usage		
Roofprint: 4,000 sq. ft.					
Cistern size: 20,000 gallons	2008	2,000	4		
Curtailment vol: 4,500 gallons	2009	2,000	4		
Curtailment rate: 0.7 + irr.	2011	8,000	17		
Occupancy: 3 persons	Total:	12,000			
Usage rate: 50 gpcd					
Daily use: 150 gpd					

Wimberley Rainwater Harvesting Model Summary
Interior Use & Irrigation

System Size & Water Use			Backup Water Required		
	Year	Amount (gallons)	% of total usage		
House with 3 person occupancy, 1800 sq. ft. irrigated area					
Roofprint: 4,000 sq. ft.					
Cistern size: 20,000 gallons					
Occupancy: 3 persons					
Usage rate: 50 gpcd					
Daily use: 150 gpd					
System Size & Water Use			Backup Water Required		
	Year	Amount (gallons)	% of total usage		
Roofprint: 4,000 sq. ft.					
Cistern size: 20,000 gallons					
Occupancy: 3 persons					
Usage rate: 45 gpcd					
Daily use: 135 gpd					
System Size & Water Use			Backup Water Required		
	Year	Amount (gallons)	% of total usage		
Roofprint: 4,000 sq. ft.					
Cistern size: 20,000 gallons					
Occupancy: 3 persons					
Usage rate: 40 gpcd					
Daily use: 120 gpd					
System Size & Water Use			Backup Water Required		
	Year	Amount (gallons)	% of total usage		
Roofprint: 4,000 sq. ft.					
Cistern size: 20,000 gallons					
Occupancy: 3 persons					
Usage rate: 50 gpcd					
Daily use: 150 gpd					

Wimberley Rainwater Harvesting Model Summary
Interior Use & Irrigation with Wastewater Reuse

System Size & Water Use			Backup Water Required		
	Year	Amount (gallons)	% of total usage		
House with 3 person occupancy, 1800 sq. ft. irrigated area					
Roofprint: 4,000 sq. ft.					
Cistern size: 20,000 gallons	2008	2,000	4		
Occupancy: 3 persons	2009	10,000	18		
Usage rate: 50 gpcd	2011	16,000	28		
Daily use: 150 gpd	Total:	28,000			
System Size & Water Use			Backup Water Required		
	Year	Amount (gallons)	% of total usage		
Roofprint: 4,000 sq. ft.					
Cistern size: 20,000 gallons	2009	4,000	8		
Occupancy: 3 persons	2011	12,000	23		
Usage rate: 45 gpcd	Total:	16,000			
Daily use: 135 gpd					
System Size & Water Use			Backup Water Required		
	Year	Amount (gallons)	% of total usage		
Roofprint: 4,000 sq. ft.					
Cistern size: 20,000 gallons	2011	8,000	16		
Occupancy: 3 persons	Total:	8,000			
Usage rate: 40 gpcd					
Daily use: 120 gpd					
System Size & Water Use			Backup Water Required		
	Year	Amount (gallons)	% of total usage		
Roofprint: 4,000 sq. ft.					
Cistern size: 20,000 gallons	2008	2,000	4		
Curtailment vol: 4,500 gallons	2009	4,000	8		
Curtailment rate: 0.7 + irr.	2011	8,000	17		
Occupancy: 3 persons	Total:	14,000			
Usage rate: 50 gpcd					
Daily use: 150 gpd					

Wimberley Rainwater Harvesting Model Summary
Interior Use Only

House with 3 person occupancy			
Backup Water Required			
System Size & Water Use			
Year	Amount (gallons)	% of total usage	
Roofprint:	4,000 sq. ft.		
Cistern size:	25,000 gallons	2009	6,000 11
		2011	8,000 15
Occupancy:	3 persons	Total: 14,000	
Usage rate:	50 gpcd		
Daily use:	150 gpd		
Backup Water Required			
System Size & Water Use			
Year	Amount (gallons)	% of total usage	
Roofprint:	4,000 sq. ft.		
Cistern size:	25,000 gallons	2011	4,000 8
Occupancy:	3 persons	Total: 4,000	
Usage rate:	45 gpcd		
Daily use:	135 gpd		
Backup Water Required			
System Size & Water Use			
Year	Amount (gallons)	% of total usage	
Roofprint:	4,000 sq. ft.		
Cistern size:	25,000 gallons	NONE required	
Occupancy:	3 persons		
Usage rate:	40 gpcd		
Daily use:	120 gpd		
Backup Water Required			
System Size & Water Use			
Year	Amount (gallons)	% of total usage	
Roofprint:	4,000 sq. ft.		
Cistern size:	25,000 gallons	2009	2,000 4
Curtailment vol:	4,500 gallons	2011	6,000 12
Curtailment rate:	0.7 + irr.	Total: 8,000	
Occupancy:	3 persons		
Usage rate:	50 gpcd		
Daily use:	150 gpd		

Wimberley Rainwater Harvesting Model Summary
Interior Use & Irrigation

House with 3 person occupancy, 1800 sq. ft. irrigated area			
Backup Water Required			
System Size & Water Use			
Year	Amount (gallons)	% of total usage	
Roofprint:	4,000 sq. ft.		
Cistern size:	25,000 gallons	Backup water required in 9 years	
		Max yr. =	36,000 in 2011
Occupancy:	3 persons	2nd most =	26,000 in 2009
Usage rate:	50 gpcd	Total req. = 126,000 gallons	
Daily use:	150 gpd		
Backup Water Required			
System Size & Water Use			
Year	Amount (gallons)	% of total usage	
Roofprint:	4,000 sq. ft.		
Cistern size:	25,000 gallons	Backup water required in 7 years	
		Max yr. =	32,000 in 2011
Occupancy:	3 persons	2nd most =	22,000 in 2009
Usage rate:	45 gpcd	Total req. = 88,000 gallons	
Daily use:	135 gpd		
Backup Water Required			
System Size & Water Use			
Year	Amount (gallons)	% of total usage	
Roofprint:	4,000 sq. ft.		
Cistern size:	25,000 gallons	Backup water required in 6 years	
		Max yr. =	26,000 in 2011
Occupancy:	3 persons	2nd most =	16,000 in 2009
Usage rate:	40 gpcd	Total req. = 56,000 gallons	
Daily use:	120 gpd		
Backup Water Required			
System Size & Water Use			
Year	Amount (gallons)	% of total usage	
Roofprint:	4,000 sq. ft.		
Cistern size:	25,000 gallons	Backup water required in 7 years	
		Max yr. =	10,000 in 2 years
Occupancy:	3 persons	2nd most =	8,000 in 3 years
Usage rate:	50 gpcd	Total req. = 48,000 gallons	
Daily use:	150 gpd		

Wimberley Rainwater Harvesting Model Summary
Interior Use & Irrigation with Wastewater Reuse

House with 3 person occupancy, 1800 sq. ft. irrigated area			
Backup Water Required			
System Size & Water Use			
Year	Amount (gallons)	% of total usage	
Roofprint:	4,000 sq. ft.		
Cistern size:	25,000 gallons	2009	6,000 11
		2011	10,000 17
Occupancy:	3 persons	Total: 16,000	
Usage rate:	50 gpcd		
Daily use:	150 gpd		
Backup Water Required			
System Size & Water Use			
Year	Amount (gallons)	% of total usage	
Roofprint:	4,000 sq. ft.		
Cistern size:	25,000 gallons	2011	6,000 11
Occupancy:	3 persons	Total: 6,000	
Usage rate:	45 gpcd		
Daily use:	135 gpd		
Backup Water Required			
System Size & Water Use			
Year	Amount (gallons)	% of total usage	
Roofprint:	4,000 sq. ft.		
Cistern size:	25,000 gallons	2011	4,000 8
Occupancy:	3 persons	Total: 4,000	
Usage rate:	40 gpcd		
Daily use:	120 gpd		
Backup Water Required			
System Size & Water Use			
Year	Amount (gallons)	% of total usage	
Roofprint:	4,000 sq. ft.		
Cistern size:	25,000 gallons	2009	4,000 8
Curtailment vol:	4,500 gallons	2011	6,000 12
Curtailment rate:	0.7 + irr.	Total: 10,000	
Occupancy:	3 persons		
Usage rate:	50 gpcd		
Daily use:	150 gpd		

Wimberley Rainwater Harvesting Model Summary
Interior Use Only

House with 4 person occupancy			
Backup Water Required			
System Size & Water Use			
Year	Amount (gallons)	% of total usage	
Roofprint:	4,500 sq. ft.		
Cistern size:	30,000 gallons	1999	2,000 3
		2000	4,000 5
Occupancy:	4 persons	2008	8,000 11
Usage rate:	50 gpcd	2009	16,000 22
Daily use:	200 gpd	2011	18,000 25
		Total: 48,000	
Backup Water Required			
System Size & Water Use			
Year	Amount (gallons)	% of total usage	
Roofprint:	4,500 sq. ft.		
Cistern size:	30,000 gallons	2009	10,000 15
		2011	12,000 18
Occupancy:	4 persons	Total: 22,000	
Usage rate:	50 gpcd		
Daily use:	200 gpd		
Backup Water Required			
System Size & Water Use			
Year	Amount (gallons)	% of total usage	
Roofprint:	4,500 sq. ft.		
Cistern size:	30,000 gallons	2011	4,000 7
Occupancy:	4 persons	Total: 4,000	
Usage rate:	45 gpcd		
Daily use:	180 gpd		
Backup Water Required			
System Size & Water Use			
Year	Amount (gallons)	% of total usage	
Roofprint:	4,500 sq. ft.		
Cistern size:	30,000 gallons	1999	2,000 3
Curtailment vol:	6,000 gallons	2008	2,000 3
Curtailment rate:	0.7 + irr.	2009	6,000 10
Occupancy:	4 persons	2011	10,000 17
Usage rate:	50 gpcd	Total: 20,000	
Daily use:	200 gpd		

Wimberley Rainwater Harvesting Model Summary
Interior Use & Irrigation

House with 4 person occupancy, 2400 sq. ft. irrigated area			
Backup Water Required			
System Size & Water Use			
Year	Amount (gallons)	% of total usage	
Roofprint:	4,500 sq. ft.		
Cistern size:	30,000 gallons	Backup water required in 15 years	
		Max yr. =	88,000 in 2011
Occupancy:	4 persons	2nd most =	40,000 in 2 years
Usage rate:	50 gpcd	Total req. = 298,000 gallons	
Daily use:	200 gpd		
Backup Water Required			
System Size & Water Use			
Year	Amount (gallons)	% of total usage	
Roofprint:	4,500 sq. ft.		
Cistern size:	30,000 gallons	Backup water required in 14 years	
		Max yr. =	50,000 in 2011
Occupancy:	4 persons	2nd most =	34,000 in 2009
Usage rate:	50 gpcd	Total req. = 210,000 gallons	
Daily use:	200 gpd		
Backup Water Required			
System Size & Water Use			
Year	Amount (gallons)	% of total usage	
Roofprint:	4,500 sq. ft.		
Cistern size:	30,000 gallons	Backup water required in 9 years	
		Max yr. =	42,000 in 2011
Occupancy:	4 persons	2nd most =	30,000 in 2009
Usage rate:	45 gpcd	Total req. = 142,000 gallons	
Daily use:	180 gpd		
Backup Water Required			
System Size & Water Use			
Year	Amount (gallons)	% of total usage	
Roofprint:	4,500 sq. ft.		
Cistern size:	30,000 gallons	Backup water required in 14 years	
		Max yr. =	14,000 in 2 years
Occupancy:	4 persons	2nd most =	12,000 in 2006
Usage rate:	50 gpcd	Total req. = 86,000 gallons	
Daily use:	200 gpd		

Wimberley Rainwater Harvesting Model Summary
Interior Use & Irrigation with Wastewater Reuse

House with 4 person occupancy, 2400 sq. ft. irrigated area			
Backup Water Required			
System Size & Water Use			
Year	Amount (gallons)	% of total usage	
Roofprint:	4,500 sq. ft.		
Cistern size:	30,000 gallons	1999	4,000 5
		2000	4,000 5
Occupancy:	4 persons	2006	2,000 3
Usage rate:	50 gpcd	2008	8,000 11
Daily use:	200 gpd	2009	20,000 26
		2011	22,000 29
		Total: 60,000	
Backup Water Required			
System Size & Water Use			
Year	Amount (gallons)	% of total usage	
Roofprint:	4,500 sq. ft.		
Cistern size:	30,000 gallons	2008	2,000 3
		2009	14,000 20
Occupancy:	4 persons	2011	16,000 23
Usage rate:	50 gpcd	Total: 32,000	
Daily use:	200 gpd		
Backup Water Required			
System Size & Water Use			
Year	Amount (gallons)	% of total usage	
Roofprint:	4,500 sq. ft.		
Cistern size:	30,000 gallons	2009	6,000 9
		2011	12,000 18
Occupancy:	4 persons	Total: 18,000	
Usage rate:	45 gpcd		
Daily use:	180 gpd		
Backup Water Required			
System Size & Water Use			
Year	Amount (gallons)	% of total usage	
Roofprint:	4,500 sq. ft.		
Cistern size:	30,000 gallons	1999	2,000 3
Curtailment vol:	6,000 gallons	2006	2,000 3
Curtailment rate:	0.7 + irr.	2008	6,000 8
Occupancy:	4 persons	2009	6,000 10
Usage rate:	50 gpcd	2011	10,000 17
Daily use:	200 gpd	Total: 26,000	

Wimberley Rainwater Harvesting Model Summary
Interior Use Only

System Size & Water Use			Backup Water Required		
			Year	Amount (gallons)	% of total usage
Roofprint:	5,500 sq. ft.				
Cistern size:	40,000 gallons		2008	4,000	5
			2009	18,000	21
Occupancy:	4 persons		2011	18,000	21
Usage rate:	60 gpcd		Total:	40,000	
Daily use:	240 gpd				

System Size & Water Use			Backup Water Required		
			Year	Amount (gallons)	% of total usage
Roofprint:	5,500 sq. ft.				
Cistern size:	40,000 gallons		2008	2,000	2
Curtailment vol:	7,200 gallons		2009	6,000	8
Curtailment rate:	0.7 + irr.		2011	6,000	8
Occupancy:	4 persons		Total:	14,000	
Usage rate:	60 gpcd				
Daily use:	240 gpd				

System Size & Water Use			Backup Water Required		
			Year	Amount (gallons)	% of total usage
Roofprint:	6,000 sq. ft.				
Cistern size:	50,000 gallons		2009	2,000	2
			2011	4,000	5
Occupancy:	4 persons		Total:	6,000	
Usage rate:	60 gpcd				
Daily use:	240 gpd				

System Size & Water Use			Backup Water Required		
			Year	Amount (gallons)	% of total usage
Roofprint:	6,000 sq. ft.				
Cistern size:	50,000 gallons		2009	2,000	2
Curtailment vol:	7,200 gallons		2011	4,000	5
Curtailment rate:	0.7 + irr.		Total:	6,000	
Occupancy:	4 persons				
Usage rate:	60 gpcd				
Daily use:	240 gpd				

Wimberley Rainwater Harvesting Model Summary
Interior Use & Irrigation

System Size & Water Use			Backup Water Required		
			Year	Amount (gallons)	% of total usage
Roofprint:	5,500 sq. ft.				
Cistern size:	40,000 gallons				
Occupancy:	4 persons				
Usage rate:	45 gpcd				
Daily use:	180 gpd				

System Size & Water Use			Backup Water Required		
			Year	Amount (gallons)	% of total usage
Roofprint:	5,500 sq. ft.				
Cistern size:	40,000 gallons				
Curtailment vol:	7,200 gallons				
Curtailment rate:	0.7 + irr.				
Occupancy:	4 persons				
Usage rate:	60 gpcd				
Daily use:	240 gpd				

System Size & Water Use			Backup Water Required		
			Year	Amount (gallons)	% of total usage
Roofprint:	6,000 sq. ft.				
Cistern size:	50,000 gallons				
Occupancy:	4 persons				
Usage rate:	60 gpcd				
Daily use:	240 gpd				

System Size & Water Use			Backup Water Required		
			Year	Amount (gallons)	% of total usage
Roofprint:	6,000 sq. ft.				
Cistern size:	50,000 gallons				
Curtailment vol:	7,200 gallons				
Curtailment rate:	0.7 + irr.				
Occupancy:	4 persons				
Usage rate:	60 gpcd				
Daily use:	240 gpd				

Wimberley Rainwater Harvesting Model Summary
Interior Use & Irrigation with Wastewater Reuse

System Size & Water Use			Backup Water Required		
			Year	Amount (gallons)	% of total usage
Roofprint:	5,500 sq. ft.				
Cistern size:	40,000 gallons		2000	2,000	2
			2008	4,000	5
Occupancy:	4 persons		2009	18,000	20
Usage rate:	45 gpcd		2011	18,000	20
Daily use:	180 gpd		Total:	42,000	

System Size & Water Use			Backup Water Required		
			Year	Amount (gallons)	% of total usage
Roofprint:	5,500 sq. ft.				
Cistern size:	40,000 gallons		2009	2,000	2
Curtailment vol:	7,200 gallons		2009	6,000	8
Curtailment rate:	0.7 + irr.		2011	6,000	8
Occupancy:	4 persons		Total:	14,000	
Usage rate:	60 gpcd				
Daily use:	240 gpd				

System Size & Water Use			Backup Water Required		
			Year	Amount (gallons)	% of total usage
Roofprint:	6,000 sq. ft.				
Cistern size:	50,000 gallons		2009	4,000	5
			2011	6,000	7
Occupancy:	4 persons		Total:	10,000	
Usage rate:	60 gpcd				
Daily use:	240 gpd				

System Size & Water Use			Backup Water Required		
			Year	Amount (gallons)	% of total usage
Roofprint:	6,000 sq. ft.				
Cistern size:	50,000 gallons		2011	4,000	5
Curtailment vol:	7,200 gallons				
Curtailment rate:	0.7 + irr.		Total:	4,000	
Occupancy:	4 persons				
Usage rate:	60 gpcd				
Daily use:	240 gpd				

Requirements for house with 4 person occupancy, 2,400 sq. ft. irrigated area with no wastewater irrigation											
System Size & Water Use			Backup Water Required			System Size & Water Use			Backup Water Required		
			Year	Amount (gallons)	% of total usage				Year	Amount (gallons)	% of total usage
Roofprint:	7,000 sq. ft.					Roofprint:	7,000 sq. ft.				
Cistern size:	50,000 gallons		2009	8,000	8	Cistern size:	50,000 gallons		2011	16,000	16
			2011	22,000	21				Total:	16,000	
Occupancy:	4 persons		Total:	30,000		Occupancy:	4 persons		Total:	8,000	
Usage rate:	50 gpcd					Usage rate:	40 gpcd				
Daily use:	200 gpd					Daily use:	160 gpd				

System Size & Water Use			Backup Water Required			System Size & Water Use			Backup Water Required		
			Year	Amount (gallons)	% of total usage				Year	Amount (gallons)	% of total usage
Roofprint:	7,000 sq. ft.					Roofprint:	7,000 sq. ft.				
Cistern size:	50,000 gallons		2009	8,000	8	Cistern size:	50,000 gallons		2011	4,000	5
Curtailment vol:	6,000 gallons		2011	10,000	11	Curtailment vol:	6,000 gallons		Total:	4,000	
Curtailment rate:	1.0 irr. only		Total:	18,000		Curtailment rate:	1.0 irr. only				
Occupancy:	4 persons					Occupancy:	4 persons				
Usage rate:	50 gpcd					Usage rate:	40 gpcd				
Daily use:	200 gpd					Daily use:	160 gpd				

Appendix K – Forum Flier



Investigatory Forum * Feb 10 * Don't miss it!

When:

Friday, Feb 10, 2012
8:30 am to 12 noon
(coffee at 8 am)

Where:

Lady Bird Johnson
Wildflower Center
4801 La Crosse Avenue
Austin, TX 78739-1702

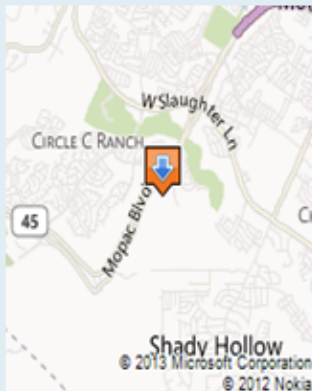

[Driving Directions](#)

Dear Stacy Bray,

The concept of rainwater harvesting used as a primary water supply for subdivision development is currently under investigation by the **Texas Water Development Board's** division of **Innovative Water Technologies**.

You and members of your organization are invited to attend a free, half-day forum that will explain the concept, present the modeling processes, explore system sizing, review cost issues, discuss backup supply strategies, review the regulatory environment, look at marketing implications, and touch on sustainability issues.

This is an opportunity to not only listen and learn, but to provide valuable input from your professional perspective during this phase of the investigation.

Also invited are leaders from a variety of stakeholder categories including **developers, homebuilders, architects, land planners, engineers, regulatory agents, and the rainwater harvesting industry**.

Mark your calendar and register today as seating is limited.

[Register Now!](#)

I can't make it

This forum is sponsored by:

[Hill Country Alliance](#)

in coordination with the
TWDB grant-funded study
team

Rainwater harvesting as a development-wide water supply strategy could have far-reaching implications in how our State will address water supply shortages in the face of limited and expensive surface supply, diminishing ground-water resources, drought, climate change, and a growing population.

More information on this study can be found on the Texas Water Development Board's website by [clicking here](#).

We look forward to seeing you soon.

Sincerely,

TWDB grant-funded study team

River Systems Institute at TSU/Meredith Blount Miller

David Venhuizen, P.E.

Karen Ford/White Hat Creative

[Forward email](#)

 SafeUnsubscribe™



Appendix L – Forum Agenda



*A grant-funded investigation through the
Innovative Water Strategies Division, Texas Water Development Board*

AGENDA

February 10, 2012

Lady Bird Johnson Wildflower Center

8:30 a.m.	Welcome & Opening Comments	Jorge Arroyo, TWDB Andy Sansom, RSI
8:40	Short film from Hill Country Alliance	Christy Muse, HCA
8:50	Background on Concept & Overview of Project	David Venhuizen, P.E.
	Review of Yield-Demand Modeling	
	Q&A and Discussion	
10:00	Break (15 min)	
10:15	Backup supply concepts	David Venhuizen, P.E.
	Regulatory environment	
	Building Design Concepts	
	Cost Considerations and Analysis	
	Marketability and Sustainability	
11:30	Final Q&A and Discussion	Study Team
12 noon	Wrap-up	Meredith Blount Miller

Project Links: <http://www.rsihillcountrywater.org/rainwater-harvesting/>
<http://www.twdb.state.tx.us/innovativewater/rainwater/projects/txstate/index.asp>

Forum Sponsor: <http://www.hillcountryalliance.org>



Appendix M – Summary Table of RHW Sizing by Location

House occupancy = 2 people (seniors oriented development)

Standard water usage rate = 45 GPCD

Cistern alarm volume = 3,000 gal. (37.5 days at reduced usage rate)

Enhanced conservation factor = 0.888 (reduces usage rate to 40 GPCD)

	Roofprint	Cistern Size	Backup Supply Required in Year						No. of years	Total	Max. year
Location	(ft ²)	(gal.)	2007	2008	2009	2010	2011	2012*	With Backup	Backup (gal.)	Backup (gal.)
Abilene	2,000	15,000	0	0	0	0	8,000	4,000	2	12,000	8,000
Athens	1,750	10,000	0	0	0	0	6,000	0	1	6,000	6,000
Austin	2,500	15,000	0	0	2,000	0	8,000	0	2	10,000	8,000
Beeville	2,500	20,000	0	0	6,000	0	2,000	2,000	3	10,000	6,000
Blanco	2,500	15,000	0	2,000	4,000	0	6,000	0	3	12,000	6,000
Boerne	2,500	15,000	0	4,000	4,000	0	6,000	0	3	14,000	6,000
Bowie	2,000	10,000	0	0	4,000	0	8,000	0	2	12,000	8,000
Brownwood	2,000	15,000	0	0	4,000	0	4,000	0	2	8,000	4,000
Burnet	2,000	15,000	0	4,000	4,000	0	6,000	0	3	14,000	6,000
Cleburne	1,750	10,000	0	0	0	0	10,000	0	1	10,000	10,000
Conroe	1,500	10,000	0	0	0	0	6,000	0	1	6,000	6,000
Corpus Christi	2,500	20,000	0	0	4,000	0	4,000	2,000	3	10,000	4,000
Dripping Springs	2,500	15,000	0	0	2,000	0	6,000	0	2	8,000	6,000
Edinburg	3,000	20,000	0	0	0	0	6,000	6,000	2	12,000	6,000
El Campo	2,000	10,000	0	0	0	0	8,000	0	1	8,000	8,000
Fredericksburg	2,500	20,000	0	0	0	0	6,000	0	1	6,000	6,000
Hondo	2,500	20,000	0	0	10,000	0	4,000	0	2	14,000	10,000

Laredo	2,500	25,000	0	0	0	0	12,000	8,000	2	20,000	12,000
Llano	2,500	15,000	0	0	4,000	0	8,000	0	2	12,000	8,000
Lufkin	1,500	10,000	0	0	0	0	4,000	0	1	4,000	4,000
Marshall	1,500	10,000	0	0	0	0	6,000	0	1	6,000	6,000
Menard	2,500	20,000	0	0	0	0	8,000	0	1	8,000	8,000
San Angelo	2,500	20,000	0	0	0	0	8,000	0	1	8,000	8,000
San Antonio	2,500	20,000	0	2,000	6,000	0	2,000	0	3	10,000	6,000
San Marcos	2,500	15,000	0	4,000	2,000	0	2,000	0	3	8,000	10,000
Sherman	1,500	10,000	0	2,000	4,000	0	4,000	0	3	10,000	4,000
Somerville Dam	2,000	10,000	0	0	2,000	0	10,000	0	2	12,000	10,000
Texarkana	1,500	7,500	0	0	0	0	4,000	0	1	4,000	4,000
Tyler	1,500	10,000	0	0	0	0	8,000	0	1	8,000	8,000
Waco	1,750	10,000	0	2,000	2,000	0	4,000	0	3	8,000	4,000
Wimberley	2,500	15,000	0	0	2,000	0	6,000	0	2	8,000	6,000

*Thru October 2012

Appendix N – Project Scale Hydrologic Analyses Output Tables

Table N1.

Project-Scale Hydrologic Analysis With and Without Rainwater Harvesting ~10% Impervious Development Native Site CN = 89 Pasture or range, Group D soils, Poor condition

Project Characteristics				Project CN and S-value							
No. of lots (houses) =		82		Project site CN w/o RWH =				90			
Total project area =		164	acres	S-value w/o RWH =				1.168			
Roadway length =		10,700	l.f.	Net CN w/ RWH (roof omitted) =				89			
Avg. roadway width =		30	ft.	S-value w/ RWH =				1.226			
Roofprint per lot =		4,500	sq. ft.	Native site CN =				89			
Other I.C. per lot =		1,000	sq. ft.	Native site S-value =				1.236			
Improved landscape per lot =		2,500	sq. ft.								
Improved landscape CN =		74									
Lawn, Group C soil, Good condition											
Developed Project Total Areas											
Impervious area, roofs included =		17.723	acres								
Impervious area, roofs not included =		9.252	acres								
Improved landscape area =		4.706	acres								
Area left in native site condition =		141.571	acres								
% Impervious Cover (incl. roofs) =		10.8%									
		Native Site	Developed Project	Change in Runoff relative to		Developed Project	Change in Runoff relative to		Change in Runoff		
	Rainfall in	Runoff	w/ RWH	Native Site Runoff		w/o RWH	Native Site Runoff		w/ RWH vs. w/o RWH		
Year	Year (in.)	(ac-ft)	(ac-ft)	(ac-ft)	%	(ac-ft)	(ac-ft)	%	ac-ft	%	
1978	30.97	128.68	122.84	-5.84	-4.5%	134.49	5.81	4.5%	11.65	9.5%	
1979	37.50	199.00	198.52	-0.48	-0.2%	205.47	6.47	3.2%	6.94	3.5%	
1980	27.38	91.44	87.40	-4.04	-4.4%	96.37	4.93	5.4%	8.97	10.3%	
1981	45.73	262.28	261.58	-0.71	-0.3%	270.09	7.81	3.0%	8.51	3.3%	
1982	26.63	81.44	77.83	-3.61	-4.4%	85.74	4.30	5.3%	7.91	10.2%	
1983	33.98	107.24	106.19	-1.04	-1.0%	113.97	6.73	6.3%	7.77	7.3%	
1984	26.30	76.11	72.81	-3.30	-4.3%	80.69	4.58	6.0%	7.88	10.8%	
1985	32.49	113.48	111.12	-2.36	-2.1%	119.11	5.63	5.0%	7.99	7.2%	
1986	35.01	144.73	142.99	-1.73	-1.2%	151.09	6.37	4.4%	8.10	5.7%	
1987	36.66	153.45	154.16	0.71	0.5%	160.28	6.83	4.5%	6.12	4.0%	
1988	19.21	52.30	50.07	-2.23	-4.3%	55.71	3.40	6.5%	5.63	11.3%	
1989	25.87	87.97	84.15	-3.83	-4.4%	93.12	5.15	5.9%	8.98	10.7%	
1990	28.44	115.63	110.38	-5.25	-4.5%	120.81	5.18	4.5%	10.43	9.5%	
1991	52.21	261.80	260.69	-1.10	-0.4%	271.68	9.88	3.8%	10.98	4.2%	
1992	46.05	181.34	186.12	4.77	2.6%	190.85	9.50	5.2%	4.73	2.5%	
1993	26.50	88.61	89.51	0.90	1.0%	93.51	4.90	5.5%	4.00	4.5%	
1994	41.16	201.90	197.09	-4.81	-2.4%	209.22	7.32	3.6%	12.13	6.2%	
1995	34.04	147.24	147.07	-0.17	-0.1%	153.94	6.71	4.6%	6.87	4.7%	
1996	29.56	102.72	98.83	-3.89	-3.8%	108.76	6.04	5.9%	9.94	10.1%	
1997	47.06	196.49	200.77	4.28	2.2%	205.80	9.31	4.7%	5.04	2.5%	
Averages	34.14	139.69	138.01	-1.69	-1.8%	146.04	6.34	4.9%	8.03	6.9%	

Table N2.

Project-Scale Hydrologic Analysis
 With and Without Rainwater Harvesting
 ~10% Impervious Development
 Native Site CN = 84
 Pasture or range, Group D soils, Fair condition

Project Characteristics				Project CN and S-value						
No. of lots (houses) =		82		Project site CN w/o RWH =		85				
Total project area =		164	acres	S-value w/o RWH =		1.734				
Roadway length =		10,700	l.f.							
Avg. roadway width =		30	ft.	Net CN w/ RWH (roof omitted) =		85				
Roofprint per lot =		4,500	sq. ft.	S-value w/ RWH =		1.830				
Other I.C. per lot =		1,000	sq. ft.							
Improved landscape per lot =		2,500	sq. ft.	Native site CN =		84				
Improved landscape CN =		74		Native site S-value =		1.905				
Lawn, Group C soil, Good condition										
Developed Project Total Areas										
Impervious area, roofs included =		17.723	acres							
Impervious area, roofs not included =		9.252	acres							
Improved landscape area =		4.706	acres							
Area left in native site condition =		141.571	acres							
% Impervious Cover (incl. roofs) =		10.8%								
Year	Rainfall in Year (in.)	Native Site Runoff (ac-ft)	Developed Project w/ RWH (ac-ft)	Change in Runoff relative to Native Site Runoff		Developed w/o RWH (ac-ft)	Change in Runoff relative to Native Site Runoff		Change in Runoff relative to Developed Site	
				(ac-ft)	%		(ac-ft)	%	ac-ft	%
1978	30.97	86.95	85.87	-1.08	-1.2%	95.52	8.57	9.9%	9.65	11.2%
1979	37.50	150.87	156.06	5.19	3.4%	161.07	10.20	6.8%	5.01	3.2%
1980	27.38	57.21	57.00	-0.21	-0.4%	64.12	6.90	12.1%	7.12	12.5%
1981	45.73	203.00	209.39	6.39	3.1%	215.77	12.77	6.3%	6.38	3.0%
1982	26.63	52.24	51.82	-0.42	-0.8%	57.99	5.75	11.0%	6.18	11.9%
1983	33.98	60.84	64.91	4.07	6.7%	70.06	9.22	15.2%	5.15	7.9%
1984	26.30	44.63	44.78	0.15	0.3%	50.85	6.22	13.9%	6.07	13.5%
1985	32.49	73.74	75.86	2.13	2.9%	81.83	8.09	11.0%	5.96	7.9%
1986	35.01	98.69	102.25	3.56	3.6%	108.23	9.54	9.7%	5.97	5.8%
1987	36.66	104.49	110.79	6.30	6.0%	114.57	10.08	9.6%	3.78	3.4%
1988	19.21	29.18	29.46	0.28	0.9%	33.70	4.52	15.5%	4.24	14.4%
1989	25.87	51.72	51.96	0.24	0.5%	59.07	7.35	14.2%	7.11	13.7%
1990	28.44	78.07	77.14	-0.93	-1.2%	85.85	7.78	10.0%	8.71	11.3%
1991	52.21	188.25	195.81	7.55	4.0%	203.84	15.59	8.3%	8.03	4.1%
1992	46.05	113.53	125.97	12.44	11.0%	127.36	13.82	12.2%	1.38	1.1%
1993	26.50	54.38	59.09	4.72	8.7%	61.25	6.87	12.6%	2.16	3.7%
1994	41.16	148.42	149.83	1.41	0.9%	159.62	11.19	7.5%	9.79	6.5%
1995	34.04	98.38	103.85	5.47	5.6%	108.53	10.15	10.3%	4.68	4.5%
1996	29.56	60.42	61.22	0.80	1.3%	68.89	8.47	14.0%	7.66	12.5%
1997	47.06	129.41	141.34	11.93	9.2%	143.20	13.79	10.7%	1.86	1.3%
Averages	34.14	94.22	97.72	3.50	3.2%	103.57	9.34	11.0%	5.85	7.7%

Table N3.

Project-Scale Hydrologic Analysis
 With and Without Rainwater Harvesting
 ~10% Impervious Development
 Native Site CN = 79
 Pasture or range, Group C soils, Fair condition

Project Characteristics				Project CN and S-value						
No. of lots (houses) =		82		Project site CN w/o RWH =			81			
Total project area =		164	acres	S-value w/o RWH =			2,359			
Roadway length =		10,700	l.f.	Net CN w/ RWH (roof omitted) =			80			
Avg. roadway width =		30	ft.	S-value w/ RWH =			2,503			
Roofprint per lot =		4,500	sq. ft.	Native site CN =			79			
Other I.C. per lot =		1,000	sq. ft.	Native site S-value =			2,658			
Improved landscape per lot =		2,500	sq. ft.							
Improved landscape CN =		74								
Lawn, Group C soil, Good condition										
Developed Project Total Areas										
Impervious area, roofs included =		17.723	acres							
Impervious area, roofs not included =		9.252	acres							
Improved landscape area =		4.706	acres							
Area left in native site condition =		141.571	acres							
% Impervious Cover (incl. roofs) =		10.8%								
Year	Rainfall in Year (in.)	Native Site Runoff (ac-ft)	Developed Project w/ RWH (ac-ft)	Change in Runoff relative to Native Site Runoff (ac-ft) %		Developed Project w/o RWH (ac-ft)	Change in Runoff relative to Native Site Runoff (ac-ft) %		Change in Runoff w/ RWH vs. w/o RWH (ac-ft) %	
1978	30.97	59.38	60.69	1.31	2.2%	68.71	9.32	15.7%	8.01	13.2%
1979	37.50	116.95	125.34	8.39	7.2%	128.66	11.70	10.0%	3.32	2.6%
1980	27.38	35.65	37.16	1.51	4.2%	42.81	7.16	20.1%	5.65	15.2%
1981	45.73	159.13	169.96	10.84	6.8%	174.52	15.39	9.7%	4.56	2.7%
1982	26.63	34.62	35.54	0.93	2.7%	40.44	5.82	16.8%	4.89	13.8%
1983	33.98	33.09	39.09	6.01	18.2%	42.07	8.98	27.1%	2.97	7.6%
1984	26.30	25.74	27.29	1.55	6.0%	31.93	6.19	24.1%	4.64	17.0%
1985	32.49	48.40	52.57	4.17	8.6%	56.84	8.44	17.4%	4.27	8.1%
1986	35.01	68.09	74.27	6.18	9.1%	78.40	10.31	15.1%	4.13	5.6%
1987	36.66	72.27	81.30	9.03	12.5%	83.11	10.84	15.0%	1.81	2.2%
1988	19.21	15.87	17.02	1.15	7.3%	20.14	4.27	26.9%	3.12	18.3%
1989	25.87	29.12	31.08	1.96	6.7%	36.56	7.44	25.6%	5.48	17.6%
1990	28.44	52.99	54.23	1.24	2.3%	61.47	8.48	16.0%	7.24	13.3%
1991	52.21	136.42	148.83	12.41	9.1%	154.26	17.84	13.1%	5.43	3.6%
1992	46.05	70.43	86.28	15.85	22.5%	84.73	14.30	20.3%	-1.55	-1.8%
1993	26.50	33.05	39.42	6.37	19.3%	40.09	7.04	21.3%	0.67	1.7%
1994	41.16	111.41	116.28	4.87	4.4%	124.17	12.76	11.4%	7.88	6.8%
1995	34.04	65.60	73.96	8.36	12.7%	76.75	11.15	17.0%	2.79	3.8%
1996	29.56	34.96	37.56	2.60	7.4%	43.23	8.26	23.6%	5.66	15.1%
1997	47.06	85.75	101.33	15.58	18.2%	100.42	14.67	17.1%	-0.91	-0.9%
Averages	34.14	64.45	70.46	6.02	9.4%	74.46	10.02	18.2%	4.00	8.3%

Table N4.

Project-Scale Hydrologic Analysis
 With and Without Rainwater Harvesting
 ~10% Impervious Development
 Native Site CN = 74
 Pasture or range, Group C soils, Good condition

Project Characteristics				Project CN and S-value						
No. of lots (houses) =		82		Project site CN w/o RWH =		77				
Total project area =		164	acres	S-value w/o RWH =		3.056				
Roadway length =		10,700	l.f.	Net CN w/ RWH (roof omitted) =		75				
Avg. roadway width =		30	ft.	S-value w/ RWH =		3.258				
Roofprint per lot =		4,500	sq. ft.							
Other I.C. per lot =		1,000	sq. ft.							
Improved landscape per lot =		2,500	sq. ft.	Native site CN =		74				
Improved landscape CN =		74		Native site S-value =		3.514				
Lawn, Group C soil, Good condition										
Developed Project Total Areas										
Impervious area, roofs included =		17.723	acres							
Impervious area, roofs not included =		9.252	acres							
Improved landscape area =		4.706	acres							
Area left in native site condition =		141.571	acres							
% Impervious Cover (incl. roofs) =		10.8%								
Year	Rainfall in Year (in.)	Native Site Runoff (ac-ft)	Developed Project w/ RWH (ac-ft)	Change in Runoff relative to Native Site Runoff		Developed Project w/o RWH (ac-ft)	Change in Runoff relative to Native Site Runoff		Change in Runoff w/ RWH vs. w/o RWH	
				(ac-ft)	%		(ac-ft)	%	ac-ft	%
1978	30.97	40.19	42.69	2.50	6.2%	49.32	9.13	22.7%	6.63	15.5%
1979	37.50	91.66	102.04	10.38	11.3%	103.94	12.28	13.4%	1.90	1.9%
1980	27.38	21.60	23.70	2.10	9.7%	28.11	6.51	30.1%	4.41	18.6%
1981	45.73	124.82	138.72	13.89	11.1%	141.68	16.86	13.5%	2.96	2.1%
1982	26.63	23.12	24.60	1.48	6.4%	28.50	5.38	23.3%	3.90	15.9%
1983	33.98	16.88	23.09	6.20	36.7%	24.12	7.23	42.8%	1.03	4.5%
1984	26.30	13.87	15.86	1.99	14.3%	19.34	5.47	39.4%	3.48	22.0%
1985	32.49	31.38	36.48	5.10	16.2%	39.40	8.02	25.5%	2.92	8.0%
1986	35.01	46.91	54.39	7.48	15.9%	56.98	10.07	21.5%	2.59	4.8%
1987	36.66	50.45	60.68	10.23	20.3%	60.74	10.29	20.4%	0.06	0.1%
1988	19.21	8.09	9.37	1.28	15.8%	11.58	3.49	43.2%	2.21	23.6%
1989	25.87	14.84	17.29	2.45	16.5%	21.39	6.54	44.1%	4.10	23.7%
1990	28.44	35.42	37.81	2.39	6.7%	43.82	8.40	23.7%	6.01	15.9%
1991	52.21	98.45	113.62	15.17	15.4%	116.74	18.29	18.6%	3.12	2.7%
1992	46.05	42.35	59.46	17.11	40.4%	55.42	13.07	30.9%	-4.04	-6.8%
1993	26.50	19.42	26.35	6.93	35.7%	25.75	6.33	32.6%	-0.60	-2.3%
1994	41.16	84.07	91.01	6.94	8.2%	97.29	13.22	15.7%	6.28	6.9%
1995	34.04	42.48	52.30	9.82	23.1%	53.48	10.99	25.9%	1.17	2.2%
1996	29.56	19.39	22.46	3.07	15.9%	26.52	7.13	36.8%	4.06	18.1%
1997	47.06	55.86	73.20	17.35	31.1%	70.03	14.17	25.4%	-3.17	-4.3%
Averages	34.14	44.06	51.26	7.19	17.9%	53.71	9.64	27.5%	2.45	8.7%

Table N5.

Project-Scale Hydrologic Analysis
 With and Without Rainwater Harvesting
 ~15% Impervious Development
 Native Site CN = 89
 Pasture or range, Group D soils, Poor condition

Project Characteristics				Project CN and S-value						
No. of lots (houses) =		82		Project site CN w/o RWH =		90				
Total project area =		105	acres	S-value w/o RWH =		1.150				
Roadway length =		8,000	l.f.							
Avg. roadway width =		30	ft.	Net CN w/ RWH (roof omitted) =		89				
Roofprint per lot =		4,500	sq. ft.	S-value w/ RWH =		1.241				
Other I.C. per lot =		1,000	sq. ft.							
Improved landscape per lot =		2,500	sq. ft.	Native site CN =		89				
Improved landscape CN =		74		Native site S-value =		1.236				
Lawn, Group C soil, Good condition										
Developed Project Total Areas										
Impervious area, roofs included =		15.863	acres							
Impervious area, roofs not included =		7.392	acres							
Improved landscape area =		4.706	acres							
Area left in native site condition =		84.431	acres							
% Impervious Cover (incl. roofs) =		15.1%								
Year	Rainfall in Year (in.)	Native Site Runoff (ac-ft)	Developed Project w/ RWH (ac-ft)	Change in Runoff relative to Native Site Runoff		Developed Project w/o RWH (ac-ft)	Change in Runoff relative to Native Site Runoff		Change in Runoff w/ RWH vs. w/o RWH	
				(ac-ft)	%		(ac-ft)	%	ac-ft	%
1978	30.97	82.39	75.48	-6.90	-8.4%	87.14	4.75	5.8%	11.66	15.4%
1979	37.50	127.41	125.74	-1.67	-1.3%	132.69	5.28	4.1%	6.95	5.5%
1980	27.38	58.54	53.60	-4.94	-8.4%	62.58	4.04	6.9%	8.98	16.7%
1981	45.73	167.93	165.78	-2.15	-1.3%	174.30	6.37	3.8%	8.52	5.1%
1982	26.63	52.14	47.75	-4.40	-8.4%	55.66	3.52	6.7%	7.92	16.6%
1983	33.98	68.66	66.38	-2.27	-3.3%	74.17	5.51	8.0%	7.78	11.7%
1984	26.30	48.73	44.60	-4.13	-8.5%	52.48	3.75	7.7%	7.89	17.7%
1985	32.49	72.65	69.26	-3.39	-4.7%	77.27	4.61	6.3%	8.00	11.6%
1986	35.01	92.66	89.76	-2.90	-3.1%	97.87	5.21	5.6%	8.11	9.0%
1987	36.66	98.25	97.70	-0.54	-0.6%	103.83	5.59	5.7%	6.13	6.3%
1988	19.21	33.49	30.64	-2.85	-8.5%	36.28	2.79	8.3%	5.64	18.4%
1989	25.87	56.32	51.55	-4.77	-8.5%	60.54	4.21	7.5%	8.99	17.4%
1990	28.44	74.03	67.83	-6.20	-8.4%	78.27	4.24	5.7%	10.44	15.4%
1991	52.21	167.61	164.69	-2.92	-1.7%	175.69	8.07	4.8%	11.00	6.7%
1992	46.05	116.10	119.13	3.03	2.6%	123.88	7.77	6.7%	4.75	4.0%
1993	26.50	56.73	56.74	0.00	0.0%	60.74	4.01	7.1%	4.01	7.1%
1994	41.16	129.27	123.11	-6.15	-4.8%	135.25	5.98	4.6%	12.14	9.9%
1995	34.04	94.27	92.87	-1.40	-1.5%	99.75	5.48	5.8%	6.88	7.4%
1996	29.56	65.76	60.77	-5.00	-7.6%	70.71	4.95	7.5%	9.95	16.4%
1997	47.06	125.80	128.37	2.57	2.0%	133.42	7.61	6.1%	5.05	3.9%
Averages	34.14	89.44	86.59	-2.85	-4.2%	94.63	5.19	6.2%	8.04	11.1%

Table N6.

Project-Scale Hydrologic Analysis
 With and Without Rainwater Harvesting
 ~15% Impervious Development
 Native Site CN = 84
 Pasture or range, Group D soils, Fair condition

Project Characteristics				Project CN and S-value						
No. of lots (houses) =		82		Project site CN w/o RWH =		86				
Total project area =		105	acres	S-value w/o RWH =		1.673				
Roadway length =		8,000	Lf.							
Avg. roadway width =		30	ft.	Net CN w/ RWH (roof omitted) =		85				
Roofprint per lot =		4,500	sq. ft.	S-value w/ RWH =		1.822				
Other I.C. per lot =		1,000	sq. ft.							
Improved landscape per lot =		2,500	sq. ft.	Native site CN =		84				
Improved landscape CN =		74		Native site S-value =		1.905				
Lawn, Group C soil, Good condition										
Developed Project Total Areas										
Impervious area, roofs included =		15.863	acres							
Impervious area, roofs not included =		7.392	acres							
Improved landscape area =		4.706	acres							
Area left in native site condition =		84.431	acres							
% Impervious Cover (incl. roofs) =		15.1%								
Year	Rainfall in Year (in.)	Native Site	Developed Project	Change in Runoff relative to Native Site Runoff		Developed Project	Change in Runoff relative to Native Site Runoff		Change in Runoff Developed Site w/ RWH vs. w/o RWH	
		Runoff (ac-ft)	w/ RWH (ac-ft)	(ac-ft)	%	w/o RWH (ac-ft)	(ac-ft)	%	ac-ft	%
1978	30.97	55.67	53.52	-2.15	-3.9%	63.28	7.61	13.7%	9.76	18.2%
1979	37.50	96.59	100.50	3.90	4.0%	105.62	9.02	9.3%	5.12	5.1%
1980	27.38	36.63	35.56	-1.08	-2.9%	42.77	6.14	16.8%	7.21	20.3%
1981	45.73	129.97	134.75	4.78	3.7%	141.24	11.28	8.7%	6.50	4.8%
1982	26.63	33.45	32.31	-1.14	-3.4%	38.58	5.13	15.3%	6.27	19.4%
1983	33.98	38.95	41.87	2.92	7.5%	47.17	8.21	21.1%	5.29	12.6%
1984	26.30	28.57	27.96	-0.62	-2.2%	34.12	5.55	19.4%	6.16	22.1%
1985	32.49	47.21	48.33	1.12	2.4%	54.40	7.19	15.2%	6.07	12.6%
1986	35.01	63.19	65.55	2.37	3.7%	71.64	8.45	13.4%	6.09	9.3%
1987	36.66	66.90	71.94	5.04	7.5%	75.84	8.95	13.4%	3.90	5.4%
1988	19.21	18.68	18.40	-0.28	-1.5%	22.72	4.04	21.6%	4.32	23.5%
1989	25.87	33.11	32.44	-0.67	-2.0%	39.65	6.54	19.7%	7.21	22.2%
1990	28.44	49.98	48.08	-1.91	-3.8%	56.88	6.90	13.8%	8.80	18.3%
1991	52.21	120.53	126.12	5.59	4.6%	134.32	13.79	11.4%	8.20	6.5%
1992	46.05	72.69	83.40	10.72	14.7%	84.97	12.28	16.9%	1.57	1.9%
1993	26.50	34.82	38.68	3.86	11.1%	40.93	6.12	17.6%	2.26	5.8%
1994	41.16	95.03	95.03	0.00	0.0%	104.94	9.91	10.4%	9.91	10.4%
1995	34.04	62.99	67.18	4.20	6.7%	71.99	9.00	14.3%	4.81	7.2%
1996	29.56	38.68	38.44	-0.25	-0.6%	46.23	7.54	19.5%	7.79	20.3%
1997	47.06	82.86	93.06	10.21	12.3%	95.10	12.24	14.8%	2.03	2.2%
Averages	34.14	60.32	62.66	2.33	2.9%	68.62	8.29	15.3%	5.96	12.4%

Table N7.

Project-Scale Hydrologic Analysis
 With and Without Rainwater Harvesting
 ~15% Impervious Development
 Native Site CN = 79
 Pasture or range, Group C soils, Fair condition

Project Characteristics				Project CN and S-value						
No. of lots (houses) =		82		Project site CN w/o RWH =		82				
Total project area =		105	acres	S-value w/o RWH =		2.248				
Roadway length =		8,000	l.f.							
Avg. roadway width =		30	ft.	Net CN w/ RWH (roof omitted) =		80				
Roofprint per lot =		4,500	sq. ft.	S-value w/ RWH =		2.467				
Other I.C. per lot =		1,000	sq. ft.							
Improved landscape per lot =		2,500	sq. ft.	Native site CN =		79				
Improved landscape CN =		74		Native site S-value =		2.658				
Lawn, Group C soil, Good condition										
Developed Project Total Areas										
Impervious area, roofs included =		15.863	acres							
Impervious area, roofs not included =		7.392	acres							
Improved landscape area =		4.706	acres							
Area left in native site condition =		84.431	acres							
% Impervious Cover (incl. roofs) =		15.1%								
Year	Rainfall in Year (in.)	Native Site Runoff (ac-ft)	Developed Project w/ RWH (ac-ft)	Change in Runoff relative to Native Site Runoff		Developed Project w/o RWH (ac-ft)	Change in Runoff relative to Native Site Runoff		Change in Runoff Developed Site w/ RWH vs. w/o RWH	
				(ac-ft)	%		(ac-ft)	%	ac-ft	%
1978	30.97	38.02	38.34	0.32	0.9%	46.53	8.51	22.4%	8.18	21.3%
1979	37.50	74.88	82.01	7.13	9.5%	85.50	10.63	14.2%	3.49	4.3%
1980	27.38	22.82	23.58	0.75	3.3%	29.38	6.56	28.7%	5.80	24.6%
1981	45.73	101.88	111.05	9.17	9.0%	115.81	13.93	13.7%	4.75	4.3%
1982	26.63	22.16	22.48	0.32	1.4%	27.50	5.34	24.1%	5.02	22.3%
1983	33.98	21.18	26.27	5.08	24.0%	29.47	8.29	39.1%	3.20	12.2%
1984	26.30	16.48	17.38	0.91	5.5%	22.17	5.69	34.6%	4.79	27.5%
1985	32.49	30.99	34.27	3.29	10.6%	38.71	7.72	24.9%	4.44	13.0%
1986	35.01	43.59	48.68	5.09	11.7%	53.01	9.42	21.6%	4.33	8.9%
1987	36.66	46.27	54.16	7.89	17.1%	56.18	9.91	21.4%	2.02	3.7%
1988	19.21	10.16	10.88	0.72	7.0%	14.11	3.95	38.8%	3.23	29.7%
1989	25.87	18.64	19.83	1.19	6.4%	25.47	6.83	36.7%	5.65	28.5%
1990	28.44	33.93	34.27	0.34	1.0%	41.67	7.74	22.8%	7.40	21.6%
1991	52.21	87.34	97.85	10.50	12.0%	103.56	16.21	18.6%	5.71	5.8%
1992	46.05	45.09	59.45	14.35	31.8%	58.21	13.11	29.1%	-1.24	-2.1%
1993	26.50	21.16	26.80	5.64	26.6%	27.63	6.47	30.6%	0.83	3.1%
1994	41.16	71.33	74.84	3.51	4.9%	82.91	11.58	16.2%	8.08	10.8%
1995	34.04	42.00	49.18	7.18	17.1%	52.16	10.16	24.2%	2.98	6.1%
1996	29.56	22.39	24.13	1.75	7.8%	30.00	7.61	34.0%	5.87	24.3%
1997	47.06	54.90	68.93	14.03	25.6%	68.30	13.40	24.4%	-0.63	-0.9%
Averages	34.14	41.26	46.22	4.96	11.7%	50.41	9.15	26.0%	4.20	13.5%

Table N8.

Project-Scale Hydrologic Analysis
 With and Without Rainwater Harvesting
 ~15% Impervious Development
 Native Site CN = 74
 Pasture or range, Group C soils, Good condition

Project Characteristics				Project CN and S-value						
No. of lots (houses) =		82		Project site CN w/o RWH =		78				
Total project area =		105	acres	S-value w/o RWH =		2.882				
Roadway length =		8,000	l.f.							
Avg. roadway width =		30	ft.	Net CN w/ RWH (roof omitted) =		76				
Roofprint per lot =		4,500	sq. ft.	S-value w/ RWH =		3.186				
Other I.C. per lot =		1,000	sq. ft.							
Improved landscape per lot =		2,500	sq. ft.	Native site CN =		74				
Improved landscape CN =		74		Native site S-value =		3.514				
Lawn, Group C soil, Good condition										
Developed Project Total Areas										
Impervious area, roofs included =		15.863	acres							
Impervious area, roofs not included =		7.392	acres							
Improved landscape area =		4.706	acres							
Area left in native site condition =		84.431	acres							
% Impervious Cover (incl. roofs) =		15.1%								
Year	Rainfall in Year (in.)	Native Site Runoff (ac-ft)	Developed Project w/ RWH (ac-ft)	Change in Runoff relative to Native Site Runoff		Developed Project w/o RWH (ac-ft)	Change in Runoff relative to Native Site Runoff		Change in Runoff w/ RWH vs. w/o RWH	
				(ac-ft)	%		(ac-ft)	%	ac-ft	%
1978	30.97	25.73	27.37	1.63	6.3%	34.21	8.48	32.9%	6.84	25.0%
1979	37.50	58.68	67.87	9.18	15.7%	69.99	11.30	19.3%	2.12	3.1%
1980	27.38	13.83	15.33	1.50	10.9%	19.95	6.12	44.2%	4.61	30.1%
1981	45.73	79.92	92.14	12.22	15.3%	95.35	15.43	19.3%	3.21	3.5%
1982	26.63	14.80	15.78	0.98	6.6%	19.83	5.03	34.0%	4.05	25.7%
1983	33.98	10.81	16.38	5.57	51.5%	17.71	6.90	63.9%	1.34	8.2%
1984	26.30	8.88	10.37	1.49	16.7%	14.03	5.14	57.9%	3.66	35.3%
1985	32.49	20.09	24.44	4.35	21.6%	27.57	7.48	37.2%	3.13	12.8%
1986	35.01	30.04	36.56	6.53	21.7%	39.38	9.35	31.1%	2.82	7.7%
1987	36.66	32.30	41.56	9.26	28.7%	41.88	9.58	29.7%	0.33	0.8%
1988	19.21	5.18	6.15	0.97	18.8%	8.51	3.33	64.3%	2.35	38.3%
1989	25.87	9.50	11.36	1.86	19.5%	15.68	6.18	65.0%	4.32	38.0%
1990	28.44	22.68	24.26	1.59	7.0%	30.46	7.78	34.3%	6.20	25.5%
1991	52.21	63.03	76.44	13.41	21.3%	79.93	16.89	26.8%	3.48	4.6%
1992	46.05	27.12	43.02	15.90	58.6%	39.37	12.25	45.2%	-3.65	-8.5%
1993	26.50	12.43	18.78	6.35	51.1%	18.37	5.94	47.8%	-0.41	-2.2%
1994	41.16	53.83	59.48	5.65	10.5%	66.01	12.18	22.6%	6.53	11.0%
1995	34.04	27.20	35.97	8.78	32.3%	37.41	10.21	37.5%	1.44	4.0%
1996	29.56	12.41	14.84	2.43	19.6%	19.15	6.74	54.3%	4.30	29.0%
1997	47.06	35.76	51.76	16.00	44.7%	48.94	13.18	36.8%	-2.82	-5.5%
Averages	34.14	28.21	34.49	6.28	23.9%	37.19	8.97	40.2%	2.69	14.3%

Table N9.

Project-Scale Hydrologic Analysis
 With and Without Rainwater Harvesting
 ~20% Impervious Development
 Native Site CN = 89
 Pasture or range, Group D soils, Poor condition

Project Characteristics				Project CN and S-value						
No. of lots (houses) =		82		Project site CN w/o RWH =		90				
Total project area =		75	acres	S-value w/o RWH =		1.134				
Roadway length =		6,250	l.f.							
Avg. roadway width =		30	ft.	Net CN w/ RWH (roof omitted) =		89				
Roofprint per lot =		4,500	sq. ft.	S-value w/ RWH =		1.264				
Other I.C. per lot =		1,000	sq. ft.							
Improved landscape per lot =		2,500	sq. ft.	Native site CN =		89				
Improved landscape CN =		74		Native site S-value =		1.236				
Lawn, Group C soil, Good condition										
Developed Project Total Areas										
Impervious area, roofs included =		14.658	acres							
Impervious area, roofs not included =		6.187	acres							
Improved landscape area =		4.706	acres							
Area left in native site condition =		55.636	acres							
% Impervious Cover (incl. roofs) =		19.5%								
Year	Rainfall in Year (in.)	Native Site Runoff (ac-ft)	Developed Project w/ RWH (ac-ft)	Change in Runoff relative to Native Site Runoff		Developed Project w/o RWH (ac-ft)	Change in Runoff relative to Native Site Runoff		Change in Runoff Developed Site w/ RWH vs. w/o RWH	
				(ac-ft)	%		(ac-ft)	%	ac-ft	%
1978	30.97	58.85	51.26	-7.58	-12.9%	62.91	4.06	6.9%	11.65	22.7%
1979	37.50	91.01	88.58	-2.43	-2.7%	95.52	4.52	5.0%	6.95	7.8%
1980	27.38	41.82	36.30	-5.51	-13.2%	45.27	3.46	8.3%	8.97	24.7%
1981	45.73	119.95	116.88	-3.07	-2.6%	125.39	5.44	4.5%	8.51	7.3%
1982	26.63	37.24	32.35	-4.89	-13.1%	40.26	3.02	8.1%	7.91	24.4%
1983	33.98	49.04	45.98	-3.06	-6.2%	53.76	4.72	9.6%	7.77	16.9%
1984	26.30	34.81	30.14	-4.67	-13.4%	38.02	3.22	9.2%	7.88	26.2%
1985	32.49	51.90	47.85	-4.05	-7.8%	55.84	3.95	7.6%	8.00	16.7%
1986	35.01	66.19	62.54	-3.65	-5.5%	70.64	4.45	6.7%	8.10	13.0%
1987	36.66	70.18	68.84	-1.34	-1.9%	74.96	4.78	6.8%	6.12	8.9%
1988	19.21	23.92	20.67	-3.25	-13.6%	26.31	2.39	10.0%	5.64	27.3%
1989	25.87	40.23	34.86	-5.37	-13.4%	43.84	3.61	9.0%	8.98	25.8%
1990	28.44	52.88	46.07	-6.81	-12.9%	56.50	3.62	6.9%	10.43	22.6%
1991	52.21	119.72	115.64	-4.09	-3.4%	126.62	6.90	5.8%	10.99	9.5%
1992	46.05	82.93	84.85	1.91	2.3%	89.58	6.65	8.0%	4.74	5.6%
1993	26.50	40.52	39.95	-0.57	-1.4%	43.96	3.43	8.5%	4.00	10.0%
1994	41.16	92.33	85.32	-7.01	-7.6%	97.45	5.12	5.5%	12.13	14.2%
1995	34.04	67.33	65.15	-2.19	-3.2%	72.02	4.69	7.0%	6.87	10.6%
1996	29.56	46.97	41.27	-5.70	-12.1%	51.21	4.23	9.0%	9.94	24.1%
1997	47.06	89.86	91.33	1.48	1.6%	96.37	6.51	7.2%	5.04	5.5%
Averages	34.14	63.88	60.29	-3.59	-7.1%	68.32	4.44	7.5%	8.03	16.2%

Table N10.

Project-Scale Hydrologic Analysis
 With and Without Rainwater Harvesting
 ~20% Impervious Development
 Native Site CN = 84
 Pasture or range, Group D soils, Fair condition

Project Characteristics				Project CN and S-value						
No. of lots (houses) =		82		Project site CN w/o RWH =		86				
Total project area =		75	acres	S-value w/o RWH =		1.613				
Roadway length =		6,250	l.f.							
Avg. roadway width =		30	ft.	Net CN w/ RWH (roof omitted) =		85				
Roofprint per lot =		4,500	sq. ft.	S-value w/ RWH =		1.821				
Other I.C. per lot =		1,000	sq. ft.							
Improved landscape per lot =		2,500	sq. ft.	Native site CN =		84				
Improved landscape CN =		74		Native site S-value =		1.905				
Lawn, Group C soil, Good condition										
Developed Project Total Areas										
Impervious area, roofs included =		14.658	acres							
Impervious area, roofs not included =		6.187	acres							
Improved landscape area =		4.706	acres							
Area left in native site condition =		55.636	acres							
% Impervious Cover (incl. roofs) =		19.5%								
Year	Rainfall in Year (in.)	Native Site Runoff (ac-ft)	Developed Project w/ RWH (ac-ft)	Change in Runoff relative to Native Site Runoff		Developed Project w/o RWH (ac-ft)	Change in Runoff relative to Native Site Runoff		Change in Runoff w/ RWH vs. w/o RWH	
				(ac-ft)	%		(ac-ft)	%	ac-ft	%
1978	30.97	39.76	36.91	-2.85	-7.2%	46.78	7.02	17.6%	9.87	26.7%
1979	37.50	69.00	72.06	3.07	4.4%	77.28	8.29	12.0%	5.22	7.2%
1980	27.38	26.17	24.53	-1.64	-6.3%	31.83	5.67	21.7%	7.30	29.8%
1981	45.73	92.83	96.56	3.73	4.0%	103.17	10.33	11.1%	6.60	6.8%
1982	26.63	23.89	22.29	-1.60	-6.7%	28.64	4.75	19.9%	6.36	28.5%
1983	33.98	27.82	30.00	2.18	7.8%	35.42	7.60	27.3%	5.42	18.1%
1984	26.30	20.41	19.29	-1.12	-5.5%	25.55	5.14	25.2%	6.26	32.4%
1985	32.49	33.72	34.18	0.46	1.4%	40.35	6.63	19.7%	6.17	18.1%
1986	35.01	45.13	46.72	1.59	3.5%	52.92	7.78	17.2%	6.20	13.3%
1987	36.66	47.78	52.01	4.22	8.8%	56.03	8.24	17.2%	4.02	7.7%
1988	19.21	13.35	12.70	-0.65	-4.9%	17.09	3.74	28.0%	4.39	34.6%
1989	25.87	23.65	22.38	-1.27	-5.4%	29.69	6.03	25.5%	7.30	32.6%
1990	28.44	35.70	33.16	-2.54	-7.1%	42.06	6.35	17.8%	8.89	26.8%
1991	52.21	86.09	90.41	4.31	5.0%	98.75	12.66	14.7%	8.35	9.2%
1992	46.05	51.92	61.51	9.59	18.5%	63.26	11.34	21.8%	1.75	2.8%
1993	26.50	24.87	28.17	3.30	13.3%	30.52	5.65	22.7%	2.35	8.3%
1994	41.16	67.88	66.96	-0.92	-1.3%	76.99	9.11	13.4%	10.03	15.0%
1995	34.04	44.99	48.36	3.37	7.5%	53.28	8.29	18.4%	4.92	10.2%
1996	29.56	27.63	26.70	-0.93	-3.4%	34.61	6.98	25.2%	7.91	29.6%
1997	47.06	59.18	68.27	9.08	15.3%	70.47	11.28	19.1%	2.20	3.2%
Averages	34.14	43.09	44.66	1.57	2.1%	50.73	7.64	19.8%	6.08	18.1%

Table N11.

Project-Scale Hydrologic Analysis
 With and Without Rainwater Harvesting
 ~20% Impervious Development
 Native Site CN = 79
 Pasture or range, Group C soils, Fair condition

Project Characteristics				Project CN and S-value						
No. of lots (houses) =		82		Project site CN w/o RWH =		82				
Total project area =		75	acres	S-value w/o RWH =		2.136				
Roadway length =		6,250	l.f.							
Avg. roadway width =		30	ft.	Net CN w/ RWH (roof omitted) =		80				
Roofprint per lot =		4,500	sq. ft.	S-value w/ RWH =		2.436				
Other I.C. per lot =		1,000	sq. ft.							
Improved landscape per lot =		2,500	sq. ft.	Native site CN =		79				
Improved landscape CN =		74		Native site S-value =		2.658				
Lawn, Group C soil, Good condition										
Developed Project Total Areas										
Impervious area, roofs included =		14.658	acres							
Impervious area, roofs not included =		6.187	acres							
Improved landscape area =		4.706	acres							
Area left in native site condition =		55.636	acres							
% Impervious Cover (incl. roofs) =		19.5%								
Year	Rainfall in Year (in.)	Native Site	Developed Project	Change in Runoff relative to Native Site Runoff		Developed Project	Change in Runoff relative to Native Site Runoff		Change in Runoff w/ RWH vs. w/o RWH	
		Runoff (ac-ft)	w/ RWH (ac-ft)	(ac-ft)	%	w/o RWH (ac-ft)	(ac-ft)	%	ac-ft	%
1978	30.97	27.16	26.84	-0.32	-1.2%	35.20	8.04	29.6%	8.36	31.1%
1979	37.50	53.48	59.80	6.32	11.8%	63.47	9.99	18.7%	3.67	6.1%
1980	27.38	16.30	16.57	0.26	1.6%	22.53	6.23	38.2%	5.96	36.0%
1981	45.73	72.77	80.86	8.09	11.1%	85.81	13.04	17.9%	4.95	6.1%
1982	26.63	15.83	15.75	-0.08	-0.5%	20.90	5.07	32.0%	5.15	32.7%
1983	33.98	15.13	19.61	4.48	29.6%	23.05	7.92	52.3%	3.44	17.5%
1984	26.30	11.77	12.26	0.49	4.1%	17.19	5.42	46.1%	4.93	40.3%
1985	32.49	22.13	24.84	2.71	12.2%	29.46	7.32	33.1%	4.62	18.6%
1986	35.01	31.14	35.52	4.38	14.1%	40.05	8.91	28.6%	4.53	12.8%
1987	36.66	33.05	40.19	7.14	21.6%	42.43	9.38	28.4%	2.23	5.6%
1988	19.21	7.26	7.69	0.43	5.9%	11.03	3.78	52.0%	3.35	43.6%
1989	25.87	13.32	14.00	0.68	5.1%	19.81	6.50	48.8%	5.82	41.6%
1990	28.44	24.23	23.99	-0.24	-1.0%	31.55	7.31	30.2%	7.55	31.5%
1991	52.21	62.39	71.65	9.26	14.8%	77.64	15.25	24.5%	5.99	8.4%
1992	46.05	32.21	45.59	13.38	41.5%	44.66	12.45	38.6%	-0.93	-2.0%
1993	26.50	15.11	20.27	5.16	34.1%	21.26	6.15	40.7%	0.99	4.9%
1994	41.16	50.95	53.57	2.62	5.1%	61.84	10.89	21.4%	8.27	15.4%
1995	34.04	30.00	36.40	6.40	21.3%	39.58	9.58	31.9%	3.18	8.7%
1996	29.56	15.99	17.18	1.19	7.4%	23.25	7.26	45.4%	6.08	35.4%
1997	47.06	39.22	52.23	13.02	33.2%	51.90	12.68	32.3%	-0.34	-0.6%
Averages	34.14	29.47	33.74	4.27	13.6%	38.13	8.66	34.5%	4.39	19.7%

Table N12.

Project-Scale Hydrologic Analysis
 With and Without Rainwater Harvesting
 ~20% Impervious Development
 Native Site CN = 74
 Pasture or range, Group C soils, Good condition

Project Characteristics				Project CN and S-value						
No. of lots (houses) =		82		Project site CN w/o RWH =		79				
Total project area =		75	acres	S-value w/o RWH =		2.708				
Roadway length =		6,250	l.f.							
Avg. roadway width =		30	ft.	Net CN w/ RWH (roof omitted) =		76				
Roofprint per lot =		4,500	sq. ft.	S-value w/ RWH =		3.118				
Other I.C. per lot =		1,000	sq. ft.							
Improved landscape per lot =		2,500	sq. ft.	Native site CN =		74				
Improved landscape CN =		74		Native site S-value =		3.514				
Lawn, Group C soil, Good condition										
Developed Project Total Areas										
Impervious area, roofs included =		14.658	acres							
Impervious area, roofs not included =		6.187	acres							
Improved landscape area =		4.706	acres							
Area left in native site condition =		55.636	acres							
% Impervious Cover (incl. roofs) =		19.5%								
Year	Rainfall in Year (in.)	Native Site Runoff (ac-ft)	Developed Project w/ RWH (ac-ft)	Change in Runoff relative to Native Site Runoff (ac-ft) %		Developed Project w/o RWH (ac-ft)	Change in Runoff relative to Native Site Runoff (ac-ft) %		Change in Runoff w/ RWH vs. w/o RWH (ac-ft) %	
1978	30.97	18.38	19.45	1.07	5.8%	26.52	8.14	44.3%	7.07	36.3%
1979	37.50	41.92	50.33	8.41	20.1%	52.67	10.76	25.7%	2.35	4.7%
1980	27.38	9.88	11.00	1.12	11.3%	15.82	5.94	60.2%	4.82	43.9%
1981	45.73	57.08	68.23	11.14	19.5%	71.69	14.61	25.6%	3.47	5.1%
1982	26.63	10.57	11.23	0.66	6.2%	15.44	4.87	46.0%	4.21	37.5%
1983	33.98	7.72	12.88	5.16	66.8%	14.54	6.82	88.3%	1.66	12.9%
1984	26.30	6.34	7.51	1.16	18.3%	11.36	5.01	79.0%	3.85	51.3%
1985	32.49	14.35	18.21	3.86	26.9%	21.56	7.21	50.2%	3.35	18.4%
1986	35.01	21.45	27.36	5.91	27.5%	30.43	8.98	41.9%	3.07	11.2%
1987	36.66	23.07	31.70	8.63	37.4%	32.31	9.24	40.1%	0.61	1.9%
1988	19.21	3.70	4.48	0.78	21.0%	6.98	3.28	88.6%	2.50	55.9%
1989	25.87	6.79	8.26	1.47	21.7%	12.82	6.03	88.8%	4.55	55.1%
1990	28.44	16.20	17.27	1.07	6.6%	23.66	7.46	46.0%	6.39	37.0%
1991	52.21	45.02	57.29	12.27	27.2%	61.16	16.13	35.8%	3.87	6.7%
1992	46.05	19.37	34.49	15.12	78.1%	31.25	11.88	61.3%	-3.24	-9.4%
1993	26.50	8.88	14.85	5.97	67.2%	14.64	5.76	64.9%	-0.21	-1.4%
1994	41.16	38.45	43.27	4.82	12.5%	50.07	11.62	30.2%	6.80	15.7%
1995	34.04	19.43	27.53	8.10	41.7%	29.23	9.81	50.5%	1.71	6.2%
1996	29.56	8.87	10.88	2.02	22.7%	15.44	6.58	74.2%	4.56	41.9%
1997	47.06	25.54	40.67	15.13	59.2%	38.22	12.67	49.6%	-2.46	-6.0%
Averages	34.14	20.15	25.84	5.69	29.9%	28.79	8.64	54.6%	2.95	21.2%

Table N13.

Project-Scale Hydrologic Analysis
 With and Without Rainwater Harvesting
 ~25% Impervious Development
 Native Site CN = 89
 Pasture or range, Group D soils, Poor condition

Project Characteristics				Project CN and S-value						
No. of lots (houses) =		82		Project site CN w/o RWH =		90				
Total project area =		53	acres	S-value w/o RWH =		1.117				
Roadway length =		4,500	l.f.							
Avg. roadway width =		30	ft.	Net CN w/ RWH (roof omitted) =		88				
Roofprint per lot =		4,500	sq. ft.	S-value w/ RWH =		1.309				
Other I.C. per lot =		1,000	sq. ft.							
Improved landscape per lot =		2,500	sq. ft.	Native site CN =		89				
Improved landscape CN =		74		Native site S-value =		1.236				
Lawn, Group C soil, Good condition										
Developed Project Total Areas										
Impervious area, roofs included =		13.453	acres							
Impervious area, roofs not included =		4.982	acres							
Improved landscape area =		4.706	acres							
Area left in native site condition =		34.841	acres							
% Impervious Cover (incl. roofs) =		25.4%								
Year	Rainfall in Year (in.)	Native Site Runoff (ac-ft)	Developed Project w/ RWH (ac-ft)	Change in Runoff relative to Native Site Runoff		Developed Project w/o RWH (ac-ft)	Change in Runoff relative to Native Site Runoff		Change in Runoff w/ RWH vs. w/o RWH	
				(ac-ft)	%		(ac-ft)	%	ac-ft	%
1978	30.97	41.59	33.35	-8.24	-19.8%	44.95	3.37	8.1%	11.61	34.8%
1979	37.50	64.31	61.15	-3.17	-4.9%	68.05	3.74	5.8%	6.91	11.3%
1980	27.38	29.55	23.49	-6.06	-20.5%	32.42	2.87	9.7%	8.93	38.0%
1981	45.73	84.76	80.80	-3.96	-4.7%	89.27	4.51	5.3%	8.47	10.5%
1982	26.63	26.32	20.95	-5.37	-20.4%	28.82	2.50	9.5%	7.87	37.6%
1983	33.98	34.66	30.85	-3.81	-11.0%	38.57	3.91	11.3%	7.72	25.0%
1984	26.30	24.60	19.42	-5.18	-21.0%	27.27	2.67	10.8%	7.84	40.4%
1985	32.49	36.67	32.00	-4.68	-12.8%	39.95	3.28	8.9%	7.95	24.9%
1986	35.01	46.77	42.41	-4.37	-9.3%	50.46	3.69	7.9%	8.06	19.0%
1987	36.66	49.59	47.48	-2.11	-4.3%	53.55	3.96	8.0%	6.07	12.8%
1988	19.21	16.90	13.28	-3.62	-21.4%	18.89	1.98	11.7%	5.61	42.2%
1989	25.87	28.43	22.48	-5.95	-20.9%	31.42	2.99	10.5%	8.94	39.8%
1990	28.44	37.37	29.97	-7.40	-19.8%	40.37	3.00	8.0%	10.40	34.7%
1991	52.21	84.61	79.39	-5.21	-6.2%	90.32	5.71	6.8%	10.93	13.8%
1992	46.05	58.61	59.45	0.84	1.4%	64.12	5.51	9.4%	4.67	7.9%
1993	26.50	28.64	27.52	-1.12	-3.9%	31.48	2.85	9.9%	3.96	14.4%
1994	41.16	65.25	57.41	-7.84	-12.0%	69.49	4.24	6.5%	12.08	21.0%
1995	34.04	47.58	44.64	-2.95	-6.2%	51.47	3.88	8.2%	6.83	15.3%
1996	29.56	33.20	26.81	-6.38	-19.2%	36.71	3.51	10.6%	9.89	36.9%
1997	47.06	63.50	63.92	0.42	0.7%	68.90	5.40	8.5%	4.97	7.8%
Averages	34.14	45.14	40.84	-4.31	-11.8%	48.82	3.68	8.8%	7.99	24.4%

Table N14.

Project-Scale Hydrologic Analysis
 With and Without Rainwater Harvesting
 ~25% Impervious Development
 Native Site CN = 84
 Pasture or range, Group D soils, Fair condition

Project Characteristics				Project CN and S-value						
No. of lots (houses) =		82		Project site CN w/o RWH =		87				
Total project area =		53	acres	S-value w/o RWH =		1.539				
Roadway length =		4,500	l.f.							
Avg. roadway width =		30	ft.	Net CN w/ RWH (roof omitted) =		85				
Roofprint per lot =		4,500	sq. ft.	S-value w/ RWH =		1.833				
Other I.C. per lot =		1,000	sq. ft.							
Improved landscape per lot =		2,500	sq. ft.	Native site CN =		84				
Improved landscape CN =		74		Native site S-value =		1.905				
Lawn, Group C soil, Good condition										
Developed Project Total Areas										
Impervious area, roofs included =		13.453	acres							
Impervious area, roofs not included =		4.982	acres							
Improved landscape area =		4.706	acres							
Area left in native site condition =		34.841	acres							
% Impervious Cover (incl. roofs) =		25.4%								
Year	Rainfall in Year (in.)	Native Site Runoff (ac-ft)	Developed Project w/ RWH (ac-ft)	Change in Runoff relative to Native Site Runoff		Developed Project w/o RWH (ac-ft)	Change in Runoff relative to Native Site Runoff		Change in Runoff Developed Site w/ RWH vs. w/o RWH	
				(ac-ft)	%		(ac-ft)	%	ac-ft	%
1978	30.97	28.10	24.54	-3.55	-12.6%	34.53	6.43	22.9%	9.98	40.7%
1979	37.50	48.76	50.98	2.23	4.6%	56.31	7.56	15.5%	5.33	10.5%
1980	27.38	18.49	16.29	-2.20	-11.9%	23.69	5.20	28.1%	7.41	45.5%
1981	45.73	65.60	68.28	2.67	4.1%	75.00	9.40	14.3%	6.73	9.9%
1982	26.63	16.88	14.81	-2.07	-12.3%	21.26	4.38	26.0%	6.45	43.6%
1983	33.98	19.66	21.08	1.42	7.2%	26.66	7.00	35.6%	5.57	26.4%
1984	26.30	14.42	12.79	-1.63	-11.3%	19.16	4.73	32.8%	6.36	49.7%
1985	32.49	23.83	23.62	-0.20	-0.9%	29.91	6.08	25.5%	6.28	26.6%
1986	35.01	31.89	32.70	0.80	2.5%	39.02	7.12	22.3%	6.32	19.3%
1987	36.66	33.77	37.16	3.39	10.0%	41.32	7.55	22.3%	4.15	11.2%
1988	19.21	9.43	8.41	-1.02	-10.8%	12.89	3.45	36.6%	4.47	53.1%
1989	25.87	16.71	14.84	-1.87	-11.2%	22.25	5.54	33.1%	7.41	49.9%
1990	28.44	25.23	22.05	-3.18	-12.6%	31.05	5.82	23.0%	9.00	40.8%
1991	52.21	60.84	63.87	3.03	5.0%	72.39	11.55	19.0%	8.52	13.3%
1992	46.05	36.69	45.15	8.46	23.1%	47.09	10.40	28.3%	1.94	4.3%
1993	26.50	17.57	20.31	2.74	15.6%	22.77	5.19	29.6%	2.46	12.1%
1994	41.16	47.97	46.13	-1.84	-3.8%	56.29	8.32	17.4%	10.16	22.0%
1995	34.04	31.79	34.33	2.53	8.0%	39.38	7.58	23.8%	5.05	14.7%
1996	29.56	19.53	17.90	-1.63	-8.3%	25.94	6.42	32.9%	8.04	44.9%
1997	47.06	41.82	49.77	7.95	19.0%	52.16	10.34	24.7%	2.39	4.8%
Averages	34.14	30.45	31.25	0.80	0.2%	37.45	7.00	25.7%	6.20	27.2%

Table N15.

Project-Scale Hydrologic Analysis
 With and Without Rainwater Harvesting
 ~25% Impervious Development
 Native Site CN = 79
 Pasture or range, Group C soils, Fair condition

Project Characteristics				Project CN and S-value						
No. of lots (houses) =		82		Project site CN w/o RWH =		83				
Total project area =		53	acres	S-value w/o RWH =		1.993				
Roadway length =		4,500	l.f.							
Avg. roadway width =		30	ft.	Net CN w/ RWH (roof omitted) =		81				
Roofprint per lot =		4,500	sq. ft.	S-value w/ RWH =		2.407				
Other I.C. per lot =		1,000	sq. ft.							
Improved landscape per lot =		2,500	sq. ft.	Native site CN =		79				
Improved landscape CN =		74		Native site S-value =		2.658				
Lawn, Group C soil, Good condition										
Developed Project Total Areas										
Impervious area, roofs included =		13.453	acres							
Impervious area, roofs not included =		4.982	acres							
Improved landscape area =		4.706	acres							
Area left in native site condition =		34.841	acres							
% Impervious Cover (incl. roofs) =		25.4%								
Year	Rainfall in Year (in.)	Native Site Runoff (ac-ft)	Developed Project w/ RWH (ac-ft)	Change in Runoff relative to Native Site Runoff		Developed Project w/o RWH (ac-ft)	Change in Runoff relative to Native Site Runoff		Change in Runoff w/ RWH vs. w/o RWH	
				(ac-ft)	%		(ac-ft)	%	ac-ft	%
1978	30.97	19.19	18.22	-0.97	-5.1%	26.80	7.61	39.6%	8.58	47.1%
1979	37.50	37.80	43.28	5.49	14.5%	47.19	9.40	24.9%	3.91	9.0%
1980	27.38	11.52	11.28	-0.24	-2.1%	17.45	5.93	51.5%	6.17	54.6%
1981	45.73	51.43	58.42	7.00	13.6%	63.62	12.20	23.7%	5.20	8.9%
1982	26.63	11.19	10.70	-0.48	-4.3%	16.02	4.84	43.2%	5.32	49.7%
1983	33.98	10.69	14.55	3.86	36.1%	18.29	7.59	71.0%	3.74	25.7%
1984	26.30	8.32	8.37	0.06	0.7%	13.50	5.18	62.3%	5.12	61.2%
1985	32.49	15.64	17.75	2.11	13.5%	22.61	6.97	44.5%	4.85	27.3%
1986	35.01	22.00	25.66	3.65	16.6%	30.44	8.44	38.4%	4.79	18.7%
1987	36.66	23.35	29.74	6.39	27.3%	32.24	8.89	38.0%	2.50	8.4%
1988	19.21	5.13	5.26	0.13	2.6%	8.76	3.63	70.9%	3.50	66.5%
1989	25.87	9.41	9.57	0.16	1.7%	15.61	6.20	65.9%	6.04	63.1%
1990	28.44	17.13	16.29	-0.83	-4.9%	24.05	6.92	40.4%	7.76	47.6%
1991	52.21	44.09	52.09	8.00	18.1%	58.44	14.35	32.6%	6.35	12.2%
1992	46.05	22.76	35.14	12.38	54.4%	34.61	11.85	52.1%	-0.53	-1.5%
1993	26.50	10.68	15.35	4.67	43.7%	16.54	5.86	54.9%	1.19	7.8%
1994	41.16	36.01	37.72	1.71	4.8%	46.25	10.25	28.5%	8.53	22.6%
1995	34.04	21.20	26.82	5.62	26.5%	30.25	9.05	42.7%	3.43	12.8%
1996	29.56	11.30	11.91	0.61	5.4%	18.26	6.97	61.6%	6.35	53.3%
1997	47.06	27.71	39.70	11.99	43.3%	39.74	12.03	43.4%	0.04	0.1%
Averages	34.14	20.83	24.39	3.57	15.3%	29.03	8.21	46.5%	4.64	29.8%

Table N16.

Project-Scale Hydrologic Analysis
 With and Without Rainwater Harvesting
 ~25% Impervious Development
 Native Site CN = 74
 Pasture or range, Group C soils, Good condition

Project Characteristics					Project CN and S-value						
No. of lots (houses) =			82		Project site CN w/o RWH =			80			
Total project area =			53	acres	S-value w/o RWH =			2.486			
Roadway length =			4,500	l.f.	Net CN w/ RWH (roof omitted) =			77			
Avg. roadway width =			30	ft.	S-value w/ RWH =			3.040			
Roofprint per lot =			4,500	sq. ft.	Native site CN =			74			
Other I.C. per lot =			1,000	sq. ft.	Native site S-value =			3.514			
Improved landscape per lot =			2,500	sq. ft.							
Improved landscape CN =			74								
Lawn, Group C soil, Good condition											
Developed Project Total Areas											
Impervious area, roofs included =			13.453	acres							
Impervious area, roofs not included =			4.982	acres							
Improved landscape area =			4.706	acres							
Area left in native site condition =			34.841	acres							
% Impervious Cover (incl. roofs) =			25.4%								
			Native Site	Developed Project	Change in Runoff relative to Native Site Runoff		Change in Runoff relative to Native Site Runoff		Change in Runoff relative to Developed Site		
	Rainfall in Year (in.)	Runoff (ac-ft)	w/ RWH (ac-ft)		(ac-ft)	%	w/o RWH (ac-ft)	(ac-ft)	%	w/ RWH vs. w/o RWH (ac-ft)	%
Year											
1978	30.97	12.99	13.49		0.50	3.8%	20.86	7.87	60.6%	7.37	54.7%
1979	37.50	29.62	37.24		7.62	25.7%	39.90	10.28	34.7%	2.66	7.1%
1980	27.38	6.98	7.70		0.72	10.3%	12.80	5.82	83.4%	5.10	66.2%
1981	45.73	40.34	50.39		10.05	24.9%	54.21	13.87	34.4%	3.82	7.6%
1982	26.63	7.47	7.79		0.32	4.3%	12.22	4.75	63.6%	4.43	56.8%
1983	33.98	5.46	10.19		4.74	86.8%	12.28	6.82	125.1%	2.09	20.5%
1984	26.30	4.48	5.31		0.83	18.5%	9.42	4.93	110.0%	4.11	77.3%
1985	32.49	10.14	13.50		3.36	33.1%	17.15	7.01	69.1%	3.65	27.0%
1986	35.01	15.16	20.43		5.27	34.8%	23.85	8.69	57.3%	3.42	16.7%
1987	36.66	16.30	24.29		7.98	49.0%	25.29	8.99	55.1%	1.00	4.1%
1988	19.21	2.61	3.18		0.57	21.8%	5.88	3.27	125.0%	2.70	84.8%
1989	25.87	4.80	5.88		1.08	22.5%	10.73	5.94	123.8%	4.86	82.6%
1990	28.44	11.45	11.99		0.54	4.7%	18.64	7.20	62.9%	6.66	55.6%
1991	52.21	31.82	42.93		11.11	34.9%	47.30	15.48	48.7%	4.37	10.2%
1992	46.05	13.69	28.00		14.32	104.6%	25.31	11.62	84.9%	-2.69	-9.6%
1993	26.50	6.27	11.86		5.58	89.0%	11.93	5.66	90.2%	0.08	0.6%
1994	41.16	27.17	31.15		3.98	14.7%	38.30	11.13	41.0%	7.15	23.0%
1995	34.04	13.73	21.14		7.41	54.0%	23.20	9.47	69.0%	2.06	9.8%
1996	29.56	6.27	7.85		1.59	25.3%	12.76	6.50	103.7%	4.91	62.5%
1997	47.06	18.05	32.29		14.24	78.9%	30.34	12.29	68.1%	-1.95	-6.1%
Averages	34.14	14.24	19.33		5.09	37.1%	22.62	8.38	75.5%	3.29	32.6%

Appendix O - Detailed Scope of Work (Submitted to TWDB)

Task 1: Data collection, overview, and background of residential-scale rainwater harvesting relative to other available water supply strategies.

This task will produce a review and discussion document providing a technical overview of using residential-scale rainwater harvesting systems under a collective management regime in conjunction with an organized backup water supply system as the water supply strategy for entire developments. Included in this report will be a description of the proposed strategy, a discussion of how this strategy compares/contrasts with conventional supply strategies, a review of factors that may recommend this strategy, and an overview of the investigations to be conducted to evaluate the merit of pursuing this strategy. Data will be collected from sources such as other states' agencies with rainwater catchment system programs, conservation data available from universities and other sources, and Alliance for Water Efficiency resources, which will be compiled with the significant resources that have already been compiled by the project team. An attachment (Preliminary Review of Project Team's Vision) to this proposal offers a preliminary review of the project team's understandings of these factors.

Task 2: Yield-demand modeling to evaluate requirements for rooftop and cistern volume and water use profiles relative to the frequency of backup supply deliveries.

This task will provide the delineation of rainwater system requirements that will serve as the baseline for all further evaluations, analysis and discussions of this strategy. A model, developed by one of this project team's co-principal investigators, will be used to evaluate the performance of a given system configuration over a number of years, through varying cycles of high and low rainfall, utilizing historic rainfall data from local weather stations. The model covers 24 years (1987-2010).

This model uses monthly calculation steps. It was evaluated against a similar model employing daily calculations steps, and it was found that the monthly model produces very similar profiles of backup water supply requirements, which is the critical piece of information provided by this model. Since far less data input labor is required for the monthly model, it is deemed adequate for this purpose.

Model inputs are rooftop, cistern volume, and daily water use, interior and/or exterior. The model calculates the volume of water that ran off the roof and deducts the water use to calculate the end-of-month volume in the cistern, the amount of water that overflowed the cistern or the amount of backup water supply that had to be added to the cistern to provide the water used in that month.

Presuming that future rainfall patterns would not markedly depart from those experienced in that historical period, this can be used to predict the expected shortfall in supply that may occur, given the rooftop, cistern volume and water use that was input. This then offers an expectation

of how much, and how frequently, backup demand would be required in the future. That allows the system designer to choose the most cost efficient system design, considering the costs and operational issues of the backup system, and to set the water use standards that should be met to achieve desired overall system performance.

The model will be used to evaluate:

- roofprint and cistern volume required make the building water-independent for a presumed water use profile, and the most efficient combination of roofprint and cistern to do so;
- amount and frequency of backup water supply incurred, given a roofprint, cistern volume and water use profile, and the most efficient combination of roofprint and cistern for this case;
- the water use profile that can be supported by a given roofprint and cistern volume to attain water independence, or to limit backup supply requirements to a desired standard;
- the impact of an enhanced conservation factor when cistern volume drops below a preset level, showing effect of behavior urged by water conservation programs of many water providers;
- the impact of adding irrigation use to the water use profile, showing the increase in required roofprint and cistern volume and/or frequency of backup supply;
- how reusing wastewater derived from rainwater used in the building can blunt that increase in required roofprint and cistern volume and/or frequency of backup supply.

Regarding water use rates, it is noted that a conventional water supply system design presumes standard demand rates which are typically very liberal estimates of what the water use may be. However, when considering a rainwater harvesting strategy, an opposite viewpoint is urged, as it is critical for cost efficiency to determine how low of a usage rate may be adequate. Setting the water use rates to be modeled is therefore a critical factor in the analysis, so the range to be examined will be agreed upon with TWDB prior to conducting the modeling process.

Any number of scenarios can be examined quite expeditiously, once rainfall data for the location to be examined is entered. The model will be used to evaluate several locations in and around the Texas Hill Country, the primary target area for this investigation. This information will frame the choices for developers, builders and system users to arrive at the most expeditious combination of roofprint area, cistern volume, demand control, and backup supply. These in turn would inform them of the various costs – direct and indirect, immediate and on-going – that would be incurred to implement and run a development-wide water supply predicated on the choices made. A report compiling the model results will be produced and shared with participants in the task 4 workshop.

Task 3: Regulatory review of state and local governments.

The strategy to be investigated envisions that individual buildings would be served by a self-contained rainwater harvesting system. For houses, the current regulatory environment addresses such systems on a similar basis as an individual lot well. Undefined, however, is the threshold for addressing multiple residential-scale systems collectively managed and/or uniformly served with an organized backup supply system. Also to be determined is how commercial and multi-family buildings would be addressed, including treatment requirements if these systems were to be classified as public. Local permitting and governance issues must also be examined.

A series of meetings and a workshop will be organized to provide information about the proposed water supply strategy and to invite input from and discussion with TCEQ staff. Agents of local regulatory systems also will be invited to participate in the workshop to discuss local governance of this strategy. Rulings and/or clarifications provided by TCEQ would serve as inputs to the presentations and discussions in the Task 4 workshop.

Task 4: Stakeholder workshop and stakeholder consultations to obtain information, input, and insights.

Completion of selected project tasks will require information, input and insights from the various parties that would plan, design, implement, operate and govern the rainwater harvesting strategy. Parties identified as sources include developers, builders, architects, planners/engineers, rainwater harvesting practitioners, water purveyors, public interest groups, regulatory agents, and public officials. A workshop will be held, to which all these parties will be offered free attendance, at which the outlines of and arguments for this strategy will be set forth and the results of the modeling process will be reviewed to set the stage for soliciting the attendees' input. The workshop will be organized and run to best stimulate the free exchange of information and insights. Participants will be able to share information, voice concerns, identify issues requiring further attention and to catalog potential barriers to implementing this strategy. Review of model simulations will allow for the development of a model instruction manual and project "tool box". The workshop will also be an opportunity to identify and engage sources of expertise with which follow-up discussions may be held to obtain more detailed information and insights on the opportunities and liabilities of the rainwater harvesting strategy.

Information gathered during this workshop and subsequent meetings will be incorporated into a report and "tool box" to be distributed to the workshop attendees for review and will eventually be incorporated into the project's outreach and education components.

In order to gauge potential interest in workshop participation, preliminary correspondence was sent to local developers, builders, engineers and rainwater collection system installers requesting statements of interest or commitment if interested. 27 respondents committed to participate, indicating strong stakeholder interest. A list of respondents who would like to participate in workshops, discussions, etc. is attached at the end of the proposal.

Task 5: Review and evaluation of backup water supply strategy to drought-proof the residential-scale rainwater harvesting systems.

Options for provision of assured backup supply to replenish cisterns of the residential-scale facilities are preliminarily identified to include:

- A minimal piped water system fed by a community well. The pipes could be sized to deliver water at low flow rates, since the timing of backup supply flows could be controlled to limit flow rates.
- Delivery of backup supply in tanker trucks, filled from a tank on the development fed from a community well.
- Delivery of backup supply in tanker trucks, filled from a tap to a public water supply.

Issues to be examined are logistics, regulatory requirements – including how this scheme would interact with a water CCN and cost. Backup strategies identified during project research activities, including any available case studies, will be evaluated for feasibility, sustainability, community perception and cost. This task will be at least partially informed by the feedback provided at the stakeholder workshop and any subsequent follow-up discussions. It is intended that a draft document providing review and analysis of backup supply systems will be produced in conjunction with the report detailing workshop activities.

Task 6: Examination of impacts of the rainwater harvesting strategy on the local hydrologic environment.

This project will address the potential for a large number of rainwater harvesting systems installed in a watershed to impact streamflow and recharge. Potential impacts will be evaluated on a site by site basis (case study sites) by executing hydrologic calculations for undeveloped conditions, developed conditions without rainwater harvesting, and developed conditions with rainwater harvesting. One of the co-principal investigators has been engaged in collaborative efforts with the City of Austin to evaluate the impact of rainwater harvesting systems on stormwater quality management, resulting in modeling that will be a useful input to such an analysis. Additionally, on-going analyses of regional watershed hydrology are being performed with the use of HSPF and similar GIS based decision support systems developed for The Cypress Creek, Blanco and Upper San Marcos watersheds and will be used project impact assessments.

A more broad approach to evaluating potential impacts on the hydrologic environment will include examinations of potential reductions in drawdown of local aquifers and reductions of effects on spring flows. This approach is addressed in Task 9.

Task 7: Cost analysis of the rainwater harvesting strategy and comparison with conventional water supply strategies.

In addition to the costs of backup water supply and of running the backup supply system previously discussed, the costs of the residential-scale facilities must be evaluated. Cost factors for a residential-scale rainwater harvesting system include provision of the required roofprint, the required cistern volume, and the treatment and pressurization facilities. The cost analysis will address all these factors and provide cost estimates for implementing this rainwater harvesting system. Individual cost components of similar collection systems will be researched and estimates will be reviewed and evaluated in consultation with architects, builders, rainwater harvesting practitioners, and construction tradesmen. It is expected that much of this information would be derived from the stakeholder workshop and follow-up discussions.

Modeling and experience indicate that to be water-independent, or to limit backup supply to minimal levels, considerably more roofprint than is provided by a typical building design would be required. Building concepts to obtain this additional roofprint, and to incorporate required cistern volume, include:

- rain barns to add roofprint, perhaps covering free-standing cisterns;
- various types of free-standing cisterns;
- foundation integrated cisterns;

- what has been termed the “veranda strategy” to create a Hill Country rainwater harvesting vernacular house design concept, adding veranda roofs around the building perimeter and building the cistern into the veranda floor, keeping all the facilities outside the house envelope but integrated with it. This strategy adds outdoor living space and shades the walls to reduce cooling loads, factors which would offset a portion of the costs of the added roofprint and the cistern.

The impacts on building cost of these strategies will be evaluated. Costs of all system components and backup supply system will be compared to expected costs of providing a conventional water system (plus the price of water). These analyses will provide an input to evaluating the merit of the rainwater harvesting strategy.

Task 8: Evaluation of impacts on marketability of rainwater harvesting water supply strategy.

Aspects of the rainwater harvesting strategy that may impact on marketability include:

- cost of installing and maintaining the residential-scale facilities and running the backup supply system, relative to installing and maintaining a conventional water system and paying for the water;
- practicality of attaining water use rates that would allow affordable building scale systems that would limit backup supply to minimal levels;
- evaluations/perceptions of water quality obtained from rainwater harvesting;
- impacts of drought contingency curtailments in conventional water supply systems vis-à-vis the discipline imparted by a dwindling cistern level.

These factors, along with any others identified in the course of the investigation, will be studied to evaluate the apparent marketability of the residential-scale rainwater harvesting water supply strategy, and to elucidate the characteristics of a development that would favor or diminish that strategy. These factors will be reviewed during the stakeholder workshop, and also will be presented to realtors, brokers, builders and lenders for review and comment. What is learned will offer guidance on how competitively developments utilizing the residential-scale rainwater harvesting water supply strategy might be marketed.

Task 9: Review and analysis of sustainability issues.

An incentive for consideration of the rainwater harvesting water supply strategy is to minimize demands on conventional supplies, to render these resources more sustainable in the face of continuing growth, and to blunt the impetus for large-scale water transfer schemes, with their attendant cost and environmental impacts. It is envisioned that developments in the primary target area that use residential-scale rainwater harvesting would *displace* a significant amount of development that would have drawn *all* of its water supply from groundwater sources. The potential effects of this rainwater collection supply strategy will be evaluated and reported.

The impact of rainwater harvesting on stormwater management is also a significant factor to consider. Direct rainwater catchment and sequestration can play a significant role. This would be explicitly evaluated in task 5, but it also has sustainability dimensions. Mitigating the impacts of development on the local hydrologic environment is a major thrust of various rules systems

which govern stormwater management. This catchment and storage prevents a significant portion of the additional quickflow imparted by development from occurring. Especially when coupled with a wastewater system which utilizes effluent for landscape irrigation, the captured rainwater – which becomes that effluent after serving interior water uses – can even more efficiently perform its plant maintenance function, and some of this irrigation water may percolate to contribute to aquifer recharge and maintenance of baseflow.

It is increasingly being recognized that integrated, watershed-based water resources management can enhance overall water use efficiency. All these sustainability factors will be evaluated in this investigation as an input to determining the merit of the rainwater harvesting strategy.

Task 10: Outreach activities to disseminate project findings/results.

The outcomes of this investigation on rainwater harvesting as a water supply strategy for Central Texas and Hill Country developments will be of interest to numerous groups as set forth in previous Task explanations. Representatives of these groups will be engaged through workshops, online surveys and some one-on-one interviews and small meetings. Thus, the input, questions, recommendations and perceived barriers from each group will be addressed in the workshop summary and final report.

Findings and conclusions of this investigation will be packaged as a communication toolbox for dissemination to these various interest groups. The yield/demand model (Task 2) will be included in this toolbox, along with instructions for its use. Additionally, a 60- to 90-minute videotaped program that delivers the findings of the investigation in a webinar-ready format will be developed and delivered on DVD. The Webinar program will be supported by a powerpoint presentation containing high resolution slide graphics and targeted handouts to support key findings and economic comparisons. An executive summary of the project's final report will be packaged in the toolbox as a brochure design and will be included in a media kit, along with a draft press release announcing the final report, graphic slides, an FAQ sheet, and a contact list for recommended interviews. Further, the toolkit will contain a complete listing of key individuals, interest groups, industry organizations, professional associations, policy makers and regulating agencies which have been a part of this investigation or will likely be interested in the study and its findings. The tool box and related information will be posted on a website developed for increasing access to information regarding Hill Country groundwater resources (currently being developed) and will be linked to several additional regional websites. Karen Ford of White Hat Creative will collaborate with project staff to develop and disseminate the education and outreach materials, as well as to produce the webinar.

Task 11: Project monitoring and quality control.

The project will be collaboratively managed by all key staff and overseen by Andrew Sansom, RSI's Executive Director and Dr. Thomas Hardy, RSI's Chief Science Officer. Monitoring and evaluation components will be developed for each task and will include measureable project objectives, structured progress indicators and provisions for collecting data and managing project records.

Key staff members will meet bi-weekly to evaluate work plans and assess progress. Quarterly progress reports will be submitted to TWDB for approval, and will include summaries of activities by task, budget expenditures and difficulties or unexpected results encountered.

Appendix P - Findings and Recommendation Notes by Topic

Modeling Activities

The model adapted for this project is used to evaluate the following:

The most efficient roof print and cistern volume required to make the building water-independent for a presumed water use profile:

It has been indicated that roof orientation and pitch relative to prevailing wind direction impacts on collection efficiency. This can have significant impact on the capture rate, but to date definitive research on this factor has not been located. High-pitched roofs are expected to be more prone to wind effects. It is important to bear this in mind when reviewing the modeling results, as a lower capture rate might create greater requirements for backup supply than are projected by the model. This is noted as an item in need of further research.

The amount and frequency of backup water supply incurred, given roof print, cistern volume and water use profile, and the most efficient combination of these:

Those who employ rainwater harvesting for their water supply typically understand the need to be reasonably conservative in their water use. It is reasonable to presume that a 50 GPCD demand rate is a default that would not significantly restrict lifestyle. It remains to be examined how far below that is compatible with a lifestyle that does not leave the RWH system users feeling deprived. It is known that those who plan RWH systems typically presume a demand rate of 35 GPCD. It may be called to question if that is a reasonable expectation. A case study will be instructive in that regard.

The conditions through the drought of 2010-2011 generally defined the most critical case for back up supply requirements, although at some locations the drought of 2008-2009 was more severe. In most cases where the backup requirement shown by the modeling results approached a manageable level during droughts, the amount of backup supply required in any other year was manageable (typically two truckloads or less for the year).

As an example, modeling results for Austin show 8,000 gallons of backup supply would have been required in 2011 under a demand curtailment scenario. Examining the model results, one 2,000-gallon tanker truckload per month would have been required from June thru September, a period over which only 0.41 inches of rain had fallen – a *very* severe condition.

As set forth above, this is considered marginally manageable for a tanker truck backup supply system. Unchecked usage (usage not monitored by the user) at 50 GPCD, or even at 45 GPCD, would incur unmanageable levels of backup supply. Although the largest annual total of backup supply would have been only six truckloads – 12,000 gallons – in each case, more than one tanker truckload would have been required within one month. This configuration could be considered right-sized around Austin given a sufficient degree of demand control through the critical drought periods.

Again, the severe conditions in 2011 are considered an outlier, a repeat of which is expected infrequently. It would be a public policy decision whether to demand an upsizing of the RWH facilities *just* to render the backup supply strategy manageable in 2011. The option would be to size the facilities to cover all needs across all other years. This is done having acknowledged that occasionally extraordinary measures – e.g., running the tanker trucks continuously – may be required to provide backup supply to these RWH systems through periods of such extraordinary drought as the 2010-2011 period appears to be, based on the overall conditions through the 25-year modeling period.

The water use profile that can be supported by a given roof print and cistern volume to attain water independence or to limit backup supply requirements to a desired standard, and the impact of an enhanced conservation curtailment rate when cistern volume drops below a preset level, showing the effect of behavior urged by drought contingency programs:

A usage rate of 40 GPCD is readily attainable by much of the population. Using the enhanced conservation curtailment rate, scenarios in which water use is reduced down to 35 GPCD when the water level in the cistern drops to the alarm level were also evaluated. These measures feasibly reduce the risk of inadequate supply.

Understanding that there exists a population with liberal water use habits, a demand rate of 60 GPCD was modeled to illustrate the impact on system sizing of failing to exercise demand control. However, with a slight increase in back up supply requirements to illustrate the impacts of practicing poor demand control, two scenarios involving 4-person occupancies with a water usage rate of 60 GPCD were performed, each with and without the curtailment scenario. In these cases, the 0.7 enhanced conservation curtailment rates resulted in the curtailed usage rate being 42 GPCD rather than 35 GPCD.

A number of scenarios were modeled for each of the modeling locations. For each location, two scenarios were performed for 2-person occupancy, one scenario was run for 2.5-person occupancy, two scenarios were run for 3-person occupancy, and three scenarios were run for 4-person occupancy. In all these scenarios, four presumptions of water usage rate were modeled: 50 GPCD, 45 GPCD, 40 GPCD, and a curtailment scenario. Under the curtailment scenario, the usage rate input to the model was 50 GPCD with a cistern alarm level (alarm level dependent on roof print, cistern capability, and number of occupants) equal to 30 days' supply if the modeled occupancy uses water at 50 GPCD. This and an enhanced conservation curtailment rate of 0.7, yielding a curtailed interior water usage rate of 35 GPCD.

The impact of adding irrigation usage to the water usage profile, showing required increase in roof print and cistern volume to support this and/or the amount and frequency of backup supply, and how using reclaimed wastewater to defray irrigation usage can blunt that increase in required roof print and cistern volume and/or the amount and frequency of backup supply:

Many, perhaps most, of the developments that may utilize this water supply strategy would manage wastewater in individual (or small-scale cluster) septic systems. Those systems can be designed to incorporate a pretreatment system and to route the effluent from that system to a subsurface drip irrigation field. This field can be arrayed to irrigate the highest value landscaping that would be irrigated in any case (presuming the building occupants wish to maintain such an improved landscape).

In all cases, adding on irrigation demands without practicing wastewater reuse would impart large increases in the 2011 backup supply requirements, and would greatly increase the number of years in which backup supply would be required.

Hydrologic Impact

It has been brought to question whether populating the landscape with rooftops from which rainwater is harvested rather than allowed to run off would reduce runoff into streams from rain events, thus degrading the hydrologic environment and perhaps impinging on downstream water rights.

Analyses were preliminarily reviewed at multiple levels:

- The roof print area was examined in isolation, comparing the amount of cistern overflow expected – this is derived from the rainwater-harvesting model – with the runoff that would flow off the native site area of this size.
- A full development was examined as a watershed, comparing the native site to the developed site with and without rainwater-harvesting being practiced.

These efforts highlight that the comparison of interest is the runoff that would have occurred in the native state of the land vs. the runoff that occurs from the developed site with rainwater harvesting (RWH) being employed. All initial findings show that employing residential-scale rainwater harvesting within a development would result in no reduction in the quantities of runoff, thus no curtailment of streamflow, from the rain events modeled, except in the case where the watershed is already very hydrologically degraded. As that is a condition that should be corrected by land management practices in any case, the conclusion is that this water supply strategy would not reduce streamflow and so affect downstream water supplies.

While the roof print-only analysis provided worst-case implications of the broad-scale practice of RWH within a watershed, the project-scale analysis offers a more realistic view. This analysis takes into account all the alterations made over the entire development, rather than just the replacement of native site areas with roof print. It includes roadways, driveways, and the alterations to the land treatment by installing improved landscaping on the lots. Again, only if the

native site was in a poor hydrologic condition and dominated by Group D soils would there have been a decrease in runoff from the post-development site with RWH being practiced relative to the native site.

As the impervious coverage of the development increases, the percentage changes in runoff post-development increase. However, the absolute magnitudes of the differences decrease because the project areas generating runoff decrease, except for the case of Group D soils in poor hydrologic condition. In that case, the negative magnitude of the difference increases with increasing impervious coverage. In any case, again, the overall patterns hold.

An alternate modeling exercise was performed to substantiate these results using more complex and widely accepted modeling software. Two sub-watersheds in the Cypress Creek Watershed were used to examine potential streamflow under various conditions: undeveloped, traditional development, and development with subdivision scale rainwater harvesting.

Flows increased by approximately 12% in all years when the impervious cover/development of the study subdivision are added to existing conditions. Modeled flows in all 3 years show very little change in potential flow when rainwater is harvested for the entire study subdivision and even with the addition of a rainwater harvesting system to the study subdivision flows do not return to predevelopment levels. These preliminary results show that flows will increase regardless of the subdivision relying on rainwater harvesting.

Furthermore, the increased flows from new developments in the watershed will carry increased amounts of non-point source pollution into streams and rivers. In some manner, rainwater-harvesting systems can help reduce the amount of non-point source pollution entering rivers. Future studies of a subdivision relying on rainwater harvesting will be able to utilize HSPF for all three scenarios and may account for water in the tanks after each precipitation event.

These analyses indicate that, unless the native site condition is quite hydrologically degraded, using residential-scale rainwater harvesting as a development-wide water supply strategy would not result in a net loss of runoff over the watershed, even if whole watersheds were to be rather intensively developed using that strategy. In developments with higher impervious cover, the data indicate that it may be necessary to install devices such as rain gardens to hold runoff on the land in order not to hydrologically degrade the watershed by significantly increasing the runoff induced by development. In that case, construction of residential-scale rainwater harvesting would decrease the magnitude of that problem.

In any case, it is clear that any water gathered in a rainwater cistern does not exit the watershed. Rather, this water is used in the building and then would be dispersed, through a wastewater system. That water would flow directly out of the watershed only if the wastewater system effluent were directly discharged to a stream. Even in that case, this would be a more steady flow than stormwater runoff, so it would enhance baseflow at the expense of quickflow. If the wastewater were dispersed into the soil, it would either evapotranspire or percolate through the soil, perhaps contributing to baseflow in streams or recharge to aquifers.

This being the case, it can be argued that broad-scale practice of rainwater harvesting, even at a high development density, would improve a watershed, which is in a hydrologically degraded

condition. The harvested rainwater would be withheld from the flash hydrology, which is exacerbated by the degraded condition of the watershed. Any water that becomes effluent or is discharged to augment baseflow instead of flashing off the land, would improve the overall hydrologic condition of the watershed.

Working under the presumption that wastewater management practices are sensitive to the receiving environment, any areas that may be irrigated with the treated wastewater would provide hydrologically improved surfaces, and these would help to restore the hydrologic integrity of that little part of the watershed.

The conclusion from these analyses is that the broad-scale practice of residential-scale rainwater harvesting would not hydrologically degrade a watershed. Indeed, in most cases, it appears that rainwater harvesting would actually stave off the degradation of watershed hydrology brought on by development. It would do this by reducing the amount of increased through the sequestration of runoff in the rainwater cistern.

Regulatory Status

During the course of this project efforts were made to engage and include the governmental/regulatory agents that may place limits or restrictions on the proposed use of individual residential-scale RWH systems as the water supply strategy for all buildings in new developments. Detailed responses were not has obtained and so little specific information has been compiled regarding governmental/regulatory issues and the conditions under which this rainwater harvesting water supply strategy may be implemented.

Communications with TCEQ have confirmed that a residential-scale RWH system will retain its current unregulated status unless there is a direct connection of that property to a public water supply system. In that case, subsequent to a legislative dictate, rules are being developed to govern that situation. Release of those rules for comment has been delayed and they have not been made available as of this writing.

What has not been clarified is the status of other means of providing backup water supply. A critical determination is the status of this water. It would be deposited into the rainwater cistern. It is clear that, if this were a regulated water supply system, the water in the cistern would not be classified as potable water. It would not become potable until after it passed through the treatment unit. Therefore, this brings into question whether the backup supply system has to conform in all regards to rules in Chapter 290 regarding either trucked water or piped water, presuming these supplies would be the only water supply source. These contain provisions relating to capacity, which would not seem applicable to a water source that used only as an occasional backup water supply.

A similar consideration is needed concerning water produced from a well and delivered to the cistern in a pipe. It has been called to question whether the pipe system would need to comply in all regards to Chapter 290 rules for water distribution systems. This would apply to various design details, the most impactful being the sizes of the pipes. In particular, the water could be delivered to the cistern at an instantaneous flow rate well below the peak water usage rates in the building, so all of the sizing presumptions in Chapter 290 would not be required to assure

adequate capacity for the capability of this distribution system. This matter also needs to be clarified.

It has been brought to question if a standardized or minimum treatment train should be defined, or if this matter should continue in its current caveat emptor status. This can be considered at the TCEQ regulatory level, or at the county governance level, as reviewed below. In summary, the status of and rules regarding backup supply systems need to be investigated and clarified, and rules applying to a residential-scale RWH for which the backup supply system is a public water supply connection on the property need to be reviewed. These matters must be explicated in order to resolve what rules would or would not apply to a water supply system for a whole development in which each building has its own residential-scale RWH system.

Provisions must be made when creating a subdivision supplied by rainwater to assure a safe and adequate water supply to each building. This concept is encapsulated in the shorthand term water availability. Surprisingly, requirements for demonstrating water availability when applying for a subdivision plat are very uneven among various county governments. Many counties essentially have no requirements to demonstrate water availability. Some require minimum lot sizes if private wells are the presumed water source, typically driven by the Chapter 285 regulations governing on-site wastewater systems, with no requirements to show that an adequate well could actually be drilled on each lot. In order to lend certainty to the platting requirements for subdivision proposing residential-scale RWH systems as the water supply strategy for all lots in the subdivision, it must be clarified what, if any, requirements to demonstrate water availability must be provided when applying for the subdivision plat.

Likewise, if an obligation to assure a safe and adequate water supply to each lot is perceived by a Commissioners Court, it may be brought to question if this extends to stipulation of a standardized or minimum treatment train and/or to on-going governance issues. In particular, whether O&M of the individual residential-scale RWH systems would be left to a caveat emptor status, or whether it should be subject to some oversight. Given that the residential-scale RWH strategy would be posed as the water supply system for an entire subdivision, the view might be taken that on-going operations need to be on some organized basis, and that such an organization might need to be set forth as part of the plat application process.

Each county or municipal government must be motivated to engage and discuss these matters, and come to a resolution as to the approach to be taken in its county. This is necessary to lend certainty to the platting of a subdivision that would propose to employ this water supply strategy. In general, the county governments have not given these matters thorough examination because developers have not yet proposed to plan subdivisions presuming that residential-scale RWH would be the water supply strategy. Developers are hesitant to bring such an application before the Commissioners Court without knowing the specific system requirements.

Another aspect of county or municipal governance that requires attention is the interplay of RWH with the design sizing requirements for an on-site sewage facility (OSSF). As reviewed in Project Report No. II and Section II of this report, interior water usage by rainwater harvesters has typically been somewhat lower than is presumed in Chapter 285, the rules permitting of an OSSF. This should have implications for the per-person criteria design flow of an OSSF serving a building for which the water supply is RWH, as flow cannot be greater than input.

Next Steps for Regulatory Issues

Governmental and regulatory issues remain to be resolved to clarify the status of the residential-scale RWH water supply strategy being investigated in this project. This includes the regulatory status and requirements for the RWH system and for whatever arrangements may be made to provide a backup water supply during drought and for on-going operations and maintenance of the RWH systems.

Further efforts are recommended to engage the following entities:

- **TCEQ.** Resolve issues related to the applicability – or not – of Chapter 290 to various aspects of the proposed water supply strategy.
- **County governments.** Determine, and explicitly set forth, the requirements that would be placed on an applicant for a subdivision plat for a development proposing to use the RWH water supply strategy.
- **Municipal Governments.** Review of existing regulations, and potential barriers and gaps. Determine the requirements that would be placed on an applicant for a subdivision plat for a development proposing to use the RWH water supply strategy.

Requirements for Back-Up Supplies

The various methods for providing backup supply include the following:

- Delivery by tanker trucks, which obtain water from a public water supply source. This trucking operation may be run by a private water hauler, either under contract or on a fee for service basis, or by an organization set up to serve one or more developments which employ the RWH strategy for water supply.
- Delivery in some form of portable storage, such as a tanker truck, from one or more wells installed in the development solely for the purpose of providing backup supply. This operation may be executed by a contractor or by an organization set up to serve this development.
- Delivery from one or more wells, installed in the development solely for providing backup supply, through a minimal distribution pipe system. This pipe system may be sized to deliver the water at the daily average rate of use rather than for whatever the peak usage rate may be, since this flow would be replenishing the cistern volume rather than feeding directly into the house fixtures.
- Obtaining service from a water supply entity through a water distribution system installed within the development. This distribution system may be minimal as set forth above, or it may be fully compliant with public water supply regulations as the only water supply.

Tanker Truck from Public Water Supply Source

Capacity is a major issue for this option. From the modeling results, at a nominal occupancy and usage rate, it is to be expected that every house in the development may require a load of backup supply in the same month during a critical drought period.

Should many subdivisions employing the RWH water supply strategy in the area, several trucks may be required to provide adequate backup supply during a critical drought period. If these subdivisions are located further from available water sources, the capacity may decrease due to longer trip times.

- A fleet would have to be capitalized to provide the capacity expected to be required during the critical drought period.
- These trucks may be stranded assets, with no profitable uses during non-drought periods.

From this review, it can be seen that the ability of the existing water haulers to keep up or reliably provide services, would depend upon how widespread the RWH strategy was practiced, how well the RWH systems were right sized for the expected usage, and how effectively the users could, and would, curtail their water demands during the critical drought periods. It is also questionable how many new trucks might be capitalized, given that they may be stranded assets during non-drought periods.

Because of this, it may fall to the developer, or the residents, of a subdivision employing the RWH strategy to organize their own backup supply system. Capitalizing the truck and arranging for operation of the backup supply system would be part of setting up the overall water supply strategy. Two or more developments might collaborate to run such a system. A public entity may establish a water district like a WCID to run such a system on an area-wide basis. This would occur if it were determined that the private sector would not be able to provide the level of service deemed to be necessary.

One potential solution to the stranded assets conundrum would be to use flexible bladders. These may be installed in any available truck. Tanks or bladders installed on a trailer provide a much less expensive alternative to increasing the number of much more expensive tanker trucks. The former option may provide labor service for backup supply during critical drought periods with trucks that are already capitalized being used for other purposes. An example of this is the dump trucks used by county road departments. Some equitable means of charging for this service would have to be derived. TCEQ rules pertaining to water hauling for potable water supply are a potential barrier to using anything but a tanker truck for these endeavors.

It is notable that the water in a rainwater cistern to which the hauled water would be added, is not considered potable water. It therefore may be called to question if those rules would necessarily apply to a hauling operation dedicated solely to adding backup supply to a RWH system cistern considering the water would be run through a treatment system before use.

Delivery from Local Wells by Water Hauling Operation

Another back up supply option would be to use means other than a tanker truck that meets all the requirements of Chapter 290 for potable water hauling. This would be subject to determining

what regulatory requirements would apply to hauling of water to be delivered into the RWH system cisterns, which is a supply that is not deemed potable.

Here also, requirements applied to well(s) from which the backup water supply would be drawn need to be clarified. Chapter 290 stipulates requirements that presume the well is the sole source of water supply for the users drawing from it. In this case, it would be a source for only occasional backup supply requirements. Further, again the water would not be delivered as a potable supply, rather dumped into the RWH system cistern and go through a treatment process before being used as a potable supply in the building. TCEQ has been queried regarding what rules would apply and how they would be interpreted in this case and detailed discussions are required.

Another issue with this strategy is limitation of withdrawals from the well(s). In some circumstances, using the RWH strategy rather than depending on local groundwater would allow higher intensity development – e.g., the Hays County provision for a 6-acre minimum lot size for developments drawing water supply from the Trinity Aquifer, vs. lots as small as 1 acre with some other water supply options. Under such rules, it must be determined if wells can be used solely for backup supply without conflicting with the lot size restrictions. If so, it must be determined how to assure that the wells are not pumped for more routine water supply – e.g., for increasing irrigation usage – rather than *just* for the level of backup supply indicated by the right sizing analysis that sets the expectations of backup supply needs. These matters were to be investigated by this project, part of the review of county-level governance as applied to the RWH strategy, but little cooperation by the county governments has been obtained, leaving such investigations to be pursued in the future. It seems that coordinating these efforts through existing and newly forming stakeholder groups (that include members of local and county governments) will be more successful than requesting assistance directly from project investigators. Since employing this tactic, we have been able to collect more information although not necessarily within the scope of this project.

Delivery from Local Wells through a Minimal Distribution System

Since water could be delivered to one cistern – or at most a very few cisterns – at a time at an average rather than a peak usage flow rate, the pipes could be rather minimally sized (no larger than 2 inches) while still providing adequate capacity.

In this case also, what Chapter 290 regulations would apply to the well must be determined, as well as for the distribution system. Chapter 290 addresses water distribution systems solely with the presumption that these pipes provide the *only* water supply to the system users, not on the basis that this is only an occasional draw of backup supply. Therefore, it must first be determined if a minimally sized system is at all allowable and if so, upon what basis the minimal size would be determined. It may again be questioned if any aspect of such a backup supply system should be governed by the rules in Chapter 290, which are intended to govern and regulate potable water supply systems only. TCEQ has been queried about these matters and detailed discussions are required.

An option which avoid Chapter 290 restrictions would be to connect each well and distribution system to less than 15 connections, serving a design population of less than 25 people, so that the

entire backup supply system does not rise to the level of a public water supply system. In this case, the drilling and completion of the well(s) would be subject to applicable regulations. However, standards and governance for all other aspects of the system would appear to be subject only to caveat emptor. Under this strategy, however, it would be even more critical to put in place some means or procedures for limiting draws on the wells providing the backup supply.

Obtaining Piped Water Service from a Public Water Supply System

This option would be highly situational, subject to there being a public water system supply line within reasonable proximity to the development. In any case, the distribution system within the development would be connected to a public water supply system, so it is questionable if a minimally sized distribution system would be allowed. All the rules applicable to that public water supply system would most definitely apply to this distribution system. TCEQ has been queried about this and detailed discussions are required.

Because this option would require an initial investment in the water main extension and the distribution system, as well as payment of impact fees, connection charges, etc., to the water supply entity, it would decrease a major incentive for employing the RWH strategy within the development to begin with. Thus, this strategy may be feasible only where further increases in the number or full service connections to the public water supply system are limited by water availability.

In any case, removing the fiscal incentives for using the RWH strategy, this backup supply concept is quite unlikely to be considered within a development where it is intended that RWH be the water supply strategy. Only occasional backup supplies would be drawn from the piped water system. However, at least one developer considering the RWH strategy has indicated that a public water supply line may be extended to the development and a distribution system would be installed. This case was included in the study.

The major issues with the existing private sector backup supply strategy include the ability of entities to keep pace with demand when whole subdivisions with RWH systems are developed, and what the cost of that service would be, particularly if keeping up with capacity required fleet expansion.

Existing Water Hauling Companies Capacity and Cost of Service

As noted, because this method is already in existence and operating, providing backup supply service to rainwater harvesters at present, it is quite likely that the predominant method of backup supply would be obtaining the services of existing water hauling companies.

It appears that the previously estimated capacity of 250 houses per month per truck matches what these companies claim they can provide. However, noting the time required to fill and drain the tanker truck, this capacity might only be approached if the trip time is fairly short, no longer than 30 minutes. If developments employing the RWH strategy located further from available water sources, it is expected that the capacity per truck would decrease.

The current capacity reported by the five companies who responded to our surveys represents more than 50% of the commercial water haulers in the region. Given that all but one of them expect to expand their fleets, and that there are four more companies that did not respond operating in the same general area, it appears there is currently considerable capacity available for RWH system backup supply.

It remains to determine whether the situation is similar in other parts of the Hill Country where RWH subdivisions might be located, if the sort of capacity apparently available in the Austin/Dripping Springs area is common or is an aberration. It is recommended to canvas those areas to identify water haulers, which may serve them, and to solicit the same input from all companies identified in that process.

For the present, it is assumed that a large number of new buildings employing RWH for water supply could be supported by the private sector water haulers, at least within the areas served by the water haulers identified by this project. It remains to be determined what the limit of that capability may be and if the situation is similar in other areas of the project's prime focus area, the Texas Hill Country counties.

Stakeholder & Marketability Activities

The volume and level of interest exhibited by the response to our February 10th workshop is testament to the focus on alternative water strategies for the Hill Country and Texas. Twenty-three stakeholders provided comments and information during the project workshop. Additional contacts have been made with engineers, developers, builders, rainwater system designers/installers, architects, well drilling companies, and water hauling businesses. Information was vetted for accuracy and used in project activities and calculations related to backup water supply strategies, cost effective analysis, marketability and sustainability.

In order to gain insight into the issues affecting marketing of developments that may employ RWH as the sole source of water supply and to gain an appreciation of the implications on marketability, a focus group was assembled in August 2012. This group consisted of the following categories of stakeholders: land developers, homebuilders, architects, land planners and engineers, real estate brokers, a banker (home finance specialist), and consumers (potential homebuyers). Several interesting findings resulted from the focus group dialogue.

A theme running through many of the comments and suggestions is that **education** of participants in bringing the RWH water supply concept to fruition is vital for future project success. A number of matters were noted as being in need of further investigation or development. Listed below, in no order of priority, are those matters, and the project team's recommendation for how they may be addressed:

- Address the appraisal issue. Other than education of the appraisal community, no specific action was suggested. Further investigation of how appraisals can be rendered to reflect the value of the RWH facilities is recommended.

- Investigate/address barriers at funding institutions such as Fannie Mae and Federal secondary lending institutions. The exact nature and severity of any such barriers is unclear at present. It is notable that the local banker who participated in the focus group asserted that his bank would make loans for houses employing RWH for water supply. These barriers should be investigated and clarified.
- Investigate insurance issues, in particular the impact of employing the RWH water supply strategy on fire insurance rates.
- Develop educational resources for various audiences: developers, homebuilders, architects, consumers. That is a prime focus of this project, and all the project results will contribute to that education of the various stakeholders.

Cost Effectiveness

The option with the least first cost and essentially tied for the lowest net present value (NPV) is a community well and water distribution system within the development. It is noted that the cost estimates for this option are somewhat speculative, as no examples of a recent development, employing this water supply strategy could be located. With those caveats, the capital cost of the community well option is calculated at approximately \$11,600 per house in the development, and the NPV of 20 years of well permit fees and water costs calculates out to be about \$13,900 per house. Together these total to an NPV for this water supply option of about \$25,500 per house. Note that all system O&M costs are presumed to be funded by the water rates.

It is not known how much water rates may escalate in the future. Increased prices may drive the on-going costs of this water supply option higher. However, a community well system is a self-contained system, and as long as there is water of adequate quality in the aquifer that the well can produce, the costs of running the water system should not be prone to significant inflation.

In any case, with development depending on local groundwater for water supply, a limitation on development density may be imposed. A groundwater district or through water availability requirements dictate these limits imposed by counties in the platting process. An example of this is the portion of Hays County in which wells would draw water from the Trinity Aquifer, which has a restriction of one house per 6 acres established.

The system with the next lowest first cost, and essentially the same NPV as the community well system, involves extending a waterline from an existing public water supply system and installing a water distribution system within the development. The capital cost of this system calculates out to be about \$17,500 per house, and the NPV of the on-going water costs incurred by the users averages \$8,100 per house, totaling to an NPV of about \$25,600 per house. In this case, the presumed water usage is 6,000 gallons/month to put the on-going water costs on an “apples to apples” basis with the expected usage by clients of an RWH system.

The water supply option with the next lowest first cost and NPV is a private well serving each house in a development. This is the typical default strategy in many Hill Country developments.

The cost is estimated at \$35,000, which may be significantly impacted by required well depth and the quality of the water produced from the well. The on-going O&M costs of a private well system yield an NPV of just over \$7,800. Together these costs yield a total NPV for a private well of approximately \$42,800.

The RWH water supply option exhibited the highest first cost and an NPV similar to that of a private well. The estimated first cost is \$40,500, a figure subject to a number of caveats, in particular determination of the “right-size” of RWH system roof print and cistern volume. The NPV of 20 years’ worth of O&M is estimated to be \$7,600, yielding a total NPV for the RWH option of \$48,100.

It is concluded that the NPV of a RWH system and a private well are fairly close. However, the RWH option offers advantages in terms of water quality and long-term water security. In some jurisdictions, this is delivered in terms of potential development yield. These options may be viewed as essentially equivalent from the short-term micro-economic perspective of the developer.

Given all the caveats entailed in creating these estimates, the NPV of a RWH system and a private well are close. However, the RWH option offers advantages in terms of water quality and long-term water security and in some jurisdictions at least, in terms of potential development yield. These options may be viewed as essentially equivalent from the short-term micro-economic perspective of the developer.

Also, the RWH option would have an NPV ~\$23,000 greater than collective water supply system options. However, the RWH option would avoid any significant up-front costs to install the water system. Those cost savings may show up as lower lot costs so that the actual increase in NPV may be somewhat lower. In this case also, the RWH option may deliver water quality benefits. Additionally, the RWH option would be immune to future water cost increases or supply disruptions. Of course, this takes into account the vulnerability of the RWH option to severe, prolonged drought.

In conclusion, the RWH strategy may be essentially cost-neutral relative to a private well strategy, but is not considered cost efficient in conventional terms relative to collective water supply system options. Choosing the RWH option over those strategies would be based on factors other than the apparent raw costs of the options, such as avoiding up-front costs and the location and circumstances of the development in question.

Sustainability

A water supply strategy based on residential-scale RWH enhances sustainability by four means:

- **Directly sustaining water availability by reducing demands on conventional water supplies.** For aquifers already under stress, RWH enhances the sustainability of those water supplies and the spring fed ecosystems that those aquifers support by reducing withdrawals required to support additional development. RWH will also enhance the fiscal sustainability of conventional surface water and groundwater supplies by minimizing the need for very

high cost long-distance water transfer schemes associated with new development in areas without existing water conveyance infrastructure.

- **Urging a conservation ethic.** Increasing public awareness with respect to water consumption can be accomplished through the use of RWH demonstrations and information. RWH users develop a conservation ethic that may eventually lead to lowering of standard interior water usage rate presumptions, enhancing the sustainability of all water systems, both in terms of water use and in fiscal costs required to secure additional supplies.
- **Supporting a focus on the integrated management of all water flows to maximize beneficial use of water.** A whole water approach is expected to increase sustainability compared with continuing to employ the presently prevailing once-through model. This model refers to wastewater and stormwater runoff as nuisances to be made to go away rather than being retained to contribute to plant health and maintenance of baseflow in creeks, streams, and rivers, as well as aquifer recharge.
- **Lessening demand and pressure on aquifers that are targeted as water sources for exportation.** Where groundwater transfers are imminent, RWH may extend the supply for local uses by reducing the total amount withdrawn.

It is important to consider effects on streamflow if RWH were to be practiced on a broad scale over a watershed. Any substantial reduction in streamflow could potentially impair the sustainability of water supply systems that depend on those surface water resources (and any contribution they may provide to recharging ground water). This matter is explored in Section VI, which concludes through two modeling exercises that there is no discernible impact of RWH on overland flow and streamflow.

Many local jurisdictions in the Hill Country have adopted rules to govern stormwater management, taking into account both stormwater quality and the impacts of stormwater runoff on downstream flooding. In certain watersheds, the Texas Commission on Environmental Quality (TCEQ) has also instituted such regulations. Both the local and state efforts in this arena attest to the importance of these stormwater management functions.

If RWH were practiced on all the buildings in a development, a positive contribution would be made to management of both stormwater quality and the impacts of stormwater runoff on downstream flooding. With regard to water quantity, sequestering roof runoff in cisterns for subsequent use in buildings before discharging as wastewater provides detention storage and delays release of the water. This prevents runoff from contributing to downstream flooding problems. Overall, cistern overflows would not contribute significantly to impacts caused by the increased runoff that development induces. During all storms, which do not induce a cistern overflow – a large majority of all rainfall events – RWH removes the rooftops as impervious surfaces contributing to that increase in runoff. Thus, the interaction of RWH and stormwater management is an area that is in need of further investigation to produce rules that do recognize those benefits.

Building Scale Requirements around the State

While this project focus is upon an area generally defined as the Texas Hill Country, it is of interest how the residential-scale rainwater harvesting (RWH) water supply strategy might fare across the state. Section X reviews the results of a more limited model (spanning 2007-2012) for a number of locations in addition to the original nine Hill Country communities. The model indicates what the rightsizing of the RWH facilities might be in each location, and the impact of that sizing on the amount of backup water supply that would have been required through the modeling period. Modeling sites include the following:

- Northeast Texas – Athens, Marshall, Tyler and Texarkana
- East Central Texas – Conroe, Lufkin-Nacogdoches and Somerville Dam
- North Central Texas – Bowie, Cleburne, Sherman and Waco
- South-Southeast Texas – Beeville, Corpus Christi and El Campo
- Rio Grande Valley – Edinburg and Laredo
- West Central Texas – Abilene, Brownwood, Hondo and San Angelo
- The High Plains – Lubbock

Two types of developments were considered. One is termed a standard subdivision, and the other is a development targeted at a senior population, in which the standard occupancy is 2 people. Findings indicate that the RWH water supply strategy investigated in this project would be as viable over approximately the eastern two thirds of the state, as it is in the Hill Country communities that were the focus of this project. This strategy offers an option for water supply to standard subdivisions over much of Texas, not just in the Hill Country.

The results and the pattern of results around the state for seniors-only subdivisions are similar to those observed in the modeling of standard subdivisions. However, having to support a smaller occupancy, the RWH facilities could be smaller. In particular, the required roof print in many locations would be at or below that expected as a matter of course by a living unit and garage (or carport). The lower cistern volume would also significantly reduce the cost of the RWH facilities, as cistern volume is the major driver of RWH facilities costs.

In east, northeast and north central Texas, the rainfall patterns over the two drought periods that occurred in the 2007-2012 modeling period better supported RWH. Surprisingly, the concept appears at least as – if not more – viable over parts of west central Texas than it is in the Hill Country and the nearby IH-35 corridor communities.

RWH systems to serve houses in standard subdivisions would entail provision of extra roof print in all areas of the state except northeast and east-central Texas, where the roof print provided as a matter of course by the house and garage may suffice. These systems would also entail rather large cisterns, which pose the greatest cost challenge to implementing this water supply strategy.

For a seniors-only project, many of the locations modeled would entail roof print requirements that would have little or no extra roof print, and in many other locations only a modest area. In

summary, the RWH water supply strategy appears worthy of consideration over a large portion of Texas. It remains to determine if that strategy would be more globally cost efficient than would other strategies for water supply in each area, an evaluation that would hinge on circumstances in each locality.

Appendix Q - Modeling Process, Validation and Roof Runoff Capture

Overview of the Modeling Process

As noted, the major purpose of the modeling process is to identify the combination of roofprint and cistern size relative to water usage rate that would result in an acceptably minimal level of backup supply in any year. As noted previously, the evaluation of acceptably minimal is, of course, relative to capacity to provide backup supply. As reviewed in Section V, it is expected that, in most cases, backup supply would be provided by a tanker truck, because groundwater availability is limited and, particularly, the elimination of a piped water system would be a major incentive for choosing the RWH strategy. An example will illustrate how critical it is to minimize backup supply requirements for a tanker truck strategy.

Consider a development with 100 houses. If every house were to need a truckload of backup supply in a given month, 100 truck trips would be required during that month. Presuming 22 working days per month, that implies $100/22 = 4.5$ trips per day. Depending on travel distance from the water source to this development, one truck may be expected to provide that level of service, implying that this truck might need to be essentially dedicated to serving this one development. If this RWH strategy were implemented broadly throughout a region, than many tanker trucks would have to be available full time as backup supply service during prolonged droughts. These are assets which may or may not have other profitable uses at times when not used for backup supply, but if so, they would have to be activities which could be suspended whenever the demand for backup supply picks up. This indicates that for a trucked-in backup supply system to be manageable, the need for backup supply by any one house would have to be limited to a very few truckloads in even the worst year. As noted previously, in general the standard imposed is that a house would not need multiple loads in any one calendar month.

This then sets the goal for right-sizing the RWH facilities, and the modeling process allows examination of the requirements for right-sizing in any given scenario. That in turn is a major determinant of the costs of those RWH facilities, and thus of how cost efficient this strategy would be relative to the other water supply strategies available for any given development.

Modeling was conducted for nine weather stations in and around the Hill Country: Austin, Blanco, Boerne, Burnet, Dripping Springs, Fredericksburg, Menard, San Marcos and Wimberley. The station locations are shown below in Figure N1. Menard was included to observe how viable this RWH strategy may be as one goes further out on the Edwards Plateau. The other locations cover the area where development in the Hill Country is more active.

A range of house occupancies were modeled for each of the nine weather stations. These include:

- 2-person occupancy. It is expected that a significant part of the market for housing in this region would be for retirees, the so-called “empty nesters”. The truth of this is well illustrated by Sun City, a very sizeable development near Georgetown. There is at least one development targeted explicitly at that population being planned near Dripping Springs, the principals of which intend to utilize this residential-scale rainwater harvesting strategy.
- 2.5-person occupancy. This envisions the same sort of development but allows provision for frequent guests, such as visits by grandchildren.
- 3-person occupancy. This could accommodate the same sort of market with allowance for living with an adult parent or other loved one. It would also accommodate a single-child family or a single parent with two children, not uncommon demographics in these times.
- 4-person occupancy. This is the rather standard 3-bedroom home occupancy, and is likely to be the normal general planning number for spec homes (homes built to a typical set of common specifications, without a particular buyer in mind). It is noted that the demographics of most Hill Country developments yield average occupancy rates lower than 4 people, but the RWH system for each house must be planned for full occupancy.

It is noted that the irrigation demand profile used in this modeling process is typical for keeping a Bermuda grass lawn in Central Texas regularly watered and maintained. This is expected to represent a fairly high-usage condition. Many current rainwater harvesters, cognizant of the limitations of their rainwater systems, do not install large areas of carpet or turf grass, and if installed, do not heavily irrigate them with rainwater. A somewhat lower irrigation demand profile through the peak irrigation period would suffice to maintain a native plant landscape – including native adapted grasses which can provide a carpet grass aesthetic. The profile shown in Figure 1 is used, however, as again this RWH strategy is being evaluated for broadscale application, to serve a more general population.

The periods of lowest rainfall would control the right-sizing of RWH system facilities to hold backup supply requirements in check through the worst case conditions. The severity of that case in this region is illustrated in Table Q1 in Appendix X. The most recent periods of drought in 2008-2009 and, especially, in 2010-2011 dominate the worst case conditions over the 25-year modeling period. In particular, the 2010-2011 period almost totally populates the lowest through 4th lowest 12-month rainfall totals. The impact of this on facility sizing is reviewed in the modeling summaries, showing that in most cases facilities need to be upsized just to hold 2011 backup supply in check. This generally being an outlier condition, requiring significantly more backup supply than in any other year, it is to be expected that sizing rooftop and cistern capacity to cover 2011 would provide an RWH system that could be presumed able to cover all future conditions, even though, according to many projections, this region may experience continuing drought conditions for many years.

A number of scenarios were modeled for each of the modeling locations. For each location, two scenarios were run for 2-person occupancy, one scenario was run for 2.5-person occupancy, two scenarios were run for 3-person occupancy, and three scenarios were run for 4-person occupancy. In all these scenarios, four presumptions of interior water usage rate were modeled: 50 GPCD, 45 GPCD, 40 GPCD, and a curtailment scenario. Under the curtailment scenario, the usage rate input to the model was 50 GPCD, along with a cistern alarm level – equal to 30 days of supply if the modeled occupancy uses water at 50 GPCD – and an enhanced conservation curtailment rate of 70 percent, yielding a curtailed interior water usage rate of $0.7 \times 50 = 35$ GPCD.

To illustrate the impacts of practicing poor demand control, two scenarios were also run for 4-person occupancy with a water usage rate of 60 GPCD, each with and without the curtailment scenario. In these cases, the 70 percent enhanced conservation curtailment rate would result in the curtailed usage rate being 42 GPCD rather than 35 GPCD.

Table N1: Summary of Lowest Rainfall Periods at Modeling Stations.

Summary of Lowest Rainfall Periods at Modeling Stations, Modeling Period 1987-2011									
Location	Lowest 3-month Rainfall Total (in.)	Period of Lowest 3-month Total	2nd Lowest 3-month Rainfall Total (in.)	Period of 2nd Lowest 3-month Total	3rd Lowest 3-month Rainfall Total (in.)	Period of 3rd Lowest 3-month Total	4th Lowest 3-month Rainfall Total (in.)	Period of 4th Lowest 3-month Total	
Austin	0.02	July-Sept. 2011	0.39	June-August 2011	1.06	Feb.-April 2011	1.09	July-Sept. 1993	
Blanco	0.98	June-Aug. 2011	1.00	July-Sept. 2011	1.17	Dec. 1995-Feb. 1996	1.18	Nov. 2008-Jan. 2009	
Boerne	0.77	Feb.-April 2011	1.04	Dec. 1995-Feb. 1996	1.09	Nov. 2008-Jan. 2009	1.14	Dec. 1998-Feb. 1999	
Burnet	0.52	July-Sept. 2011	1.03	Dec. 2005-Feb. 2006	1.24	Dec. 2007-Feb. 2008	1.27	July-Sept. 1989	
Dripping Springs	0.40	July-Sept. 2011	0.57	Dec. 1995-Feb. 1996	1.21	Feb.-April 2011	1.36	June-Aug. 2011	
Fredericksburg	0.42	June-Aug. 2011	0.88	Oct.-Dec. 2010	0.98	Dec. 2007-Feb. 2008	1.00	Dec. 2008-Feb. 2009	
Menard	0.34	Nov. 2008-Jan. 2009	0.40	June-August 2011	0.40	Dec. 1995-Feb. 1996	0.61	Nov. 1999-Jan. 2000	
San Marcos	0.68	Jan.-March 1996	0.96	Dec. 1995-Feb. 1996	0.96	July-Sept. 1993	0.97	Nov. 2008-Jan. 2009	
Wimberley	0.62	Dec. 1995-Feb. 1996	0.80	July-Sept. 1993	0.87	Feb.-Apr. 2011	0.97	Nov. 2009-Jan. 2009	
Location	Lowest 6-month Rainfall Total (in.)	Period of Lowest 6-month Total	2nd Lowest 6-month Rainfall Total (in.)	Period of 2nd Lowest 6-month Total	3rd Lowest 6-month Rainfall Total (in.)	Period of 3rd Lowest 6-month Total	4th Lowest 6-month Rainfall Total (in.)	Period of 4th Lowest 6-month Total	
Austin	2.42	April-Sept. 2011	2.56	March-Aug. 2011	3.31	Feb.-July 2011	4.21	May-Oct. 2011	
Blanco	2.58	March-Aug. 2011	2.98	April-Sept. 2011	3.08	Sept. 2008-Feb. 2009	3.60	Feb.-July 2011	
Boerne	2.95	March-Aug. 2011	3.02	Sept. 2008-Feb. 2009	3.47	Feb.-July 2011	3.98	Oct. 2007-Mar. 2008	
Burnet	3.96	July-Dec. 1989	4.54	Sept. 2008-Feb. 2009	4.55	Aug. 1989-Jan. 1990	4.66	Oct. 2010-Mar. 2011	
Dripping Springs	2.77	March-Aug. 2011	2.96	April-Sept. 2011	3.57	Feb.-July 2011	4.71	Sept. 2005-Feb. 2006	
Fredericksburg	2.87	April-Sept. 2011	2.99	Feb.-July 2011	3.05	March-Aug. 2011	3.37	Aug. 1999-Jan. 2000	
Menard	2.23	Oct. 2010-Mar. 2011	2.51	Oct. 1987-Mar. 1988	2.70	Aug. 1999-Jan. 2000	2.86	March-Aug. 2011	
San Marcos	4.08	Sept. 2008-Feb. 2009	4.41	Dec. 1995-May 1996	4.91	March-Aug. 2011	4.92	Oct. 1995-Mar. 1996	
Wimberley	3.19	Sept. 2008-Feb. 2009	3.57	March-August 2011	4.23	April-Sept. 2011	4.26	Feb.-July 2011	
Location	25-Year Avg Rainfall (in.)	Lowest 12-month Rainfall Total (in.)	Period of Lowest 12-month Total	2nd Lowest 12-month Rainfall Total (in.)	Period of 2nd Lowest 12-month Total	3rd Lowest 12-month Rainfall Total (in.)	Period of 3rd Lowest 12-month Total	4th Lowest 12-month Rainfall Total (in.)	Period of 4th Lowest 12-month Total
Austin	33.76	7.91	Oct. 2010-Sept. 2011	9.83	Nov. 2010-Oct. 2011	11.08	Dec. 2010-Nov. 2011	14.79	Sept. 2010-Aug. 2011
Blanco	33.86	9.22	Oct. 2010-Sept. 2011	11.02	Nov. 2010-Oct. 2011	11.63	Dec. 2010-Nov. 2011	13.76	Mar. 2008-Feb. 2009
Boerne	37.72	9.29	Oct. 2010-Sept. 2011	13.16	Nov. 2010-Oct. 2011	14.08	Sept. 2008-Aug. 2009	14.14	Oct. 2007-Sept. 2008
Burnet	31.93	10.39	Oct. 2010-Sept. 2011	13.40	Nov. 2010-Oct. 2011	14.34	Dec. 2010-Nov. 2011	16.26	Jan.-Dec. 2011
Dripping Springs	35.33	8.57	Oct. 2010-Sept. 2011	10.83	Nov. 2010-Oct. 2011	13.03	Dec. 2010-Nov. 2011	16.46	Aug. 1995-July 1996
Fredericksburg	30.65	6.35	Oct. 2010-Sept. 2011	7.38	Nov. 2010-Oct. 2011	9.32	Dec. 2010-Nov. 2011	10.82	Aug. 2010-July 2011
Menard	23.67	5.51	Oct. 2010-Sept. 2011	6.61	Sept. 2010-Aug. 2011	8.59	Nov. 2010-Oct. 2011	8.69	Aug. 2010-July 2011
San Marcos	34.22	11.91	Oct. 2010-Sept. 2011	13.90	Nov. 2010-Oct. 2011	15.13	April 2008-Mar. 2009	15.31	Sept. 2008-Aug. 2009
Wimberley	37.03	9.54	Oct. 2010-Sept. 2011	12.51	Nov. 2010-Oct. 2011	14.91	Dec. 2010-Nov. 2011	16.94	Feb. 2008-Jan. 2009

A scenario for each location was also run to show the size of facilities required to cover irrigation usage without wastewater reuse. An interior water usage of 50 GPCD and an occupancy of 4 people were presumed for this scenario. The impact of curtailing irrigation usage *only*, with interior usage remaining at 50 GPCD, was also modeled for this configuration of RWH facilities.

The modeling results for each of the modeling locations are displayed in the Appendices B-J. A summary review of the results for each location is offered in Appendix A. General observations common to all locations and all scenarios are offered here.

As noted, it is anticipated that backup supply would be delivered by a tanker truck, presumed to have a capacity of 2,000 gallons, so all annual backup supply totals are multiples of 2,000 gallons. The system capacity issues inherent in this strategy were previously reviewed, and this is presumed to set a limit on the level of backup supply that could be incurred by any one house in any one year and still have a backup supply system that is manageable. More critically, in recognition of those system capacity issues, without regard to the total number of truckloads required in any one year, holding the backup supply requirement to only one truckload in a given month is presumed to be necessary.

In the modeling reviews, therefore, a scenario is considered manageable if the model shows it would require no more than one 2,000-gallon tanker truckload of backup supply in any one month. It would be deemed marginally manageable if it requires only one tanker truckload per month, but for several months in a row. Otherwise, that scenario is considered unmanageable.

As just reviewed, the conditions of 2011 generally defined the most critical cases. In most cases where the backup requirement shown by the modeling results approached a manageable level in 2011, the amount of backup supply required in any other year was manageable, usually two truckloads or less for the year. Therefore, the reviews in Appendix A focus on the backup supply requirements in 2011. In the cases where backup supply requirements in other years were also unmanageable under a given scenario, that is explicitly noted.

Again, the severe conditions in 2011 are considered an outlier, a repeat of which is expected infrequently. It would be a public policy decision whether to demand an upsizing of the RWH facilities only to render the backup supply strategy manageable for 2011 conditions. The option would be to size the facilities to cover all other years and accept that very occasionally extraordinary measures (e.g., running the tanker on a much more frequent basis) may be required to provide backup supply to these RWH systems through periods of such extraordinary drought as the 2010-2011 period appears to be, based on the overall conditions through the 25-year modeling period.

For the curtailment scenarios, a lesser amount of backup supply would have been incurred by inputting a higher cistern volume at which curtailment would begin, so that curtailment would have begun with more days of supply remaining. This would be so in all scenarios for all locations. The conundrum is that it is not readily apparent that one is in drought until drought conditions are experienced, so one may not know when is too early or too late to begin curtailing demand. The cistern level where a 30-day supply remains at an interior water usage rate of 50 GPCD was chosen for uniformity among the scenarios, but is by no means implied to be the most appropriate number.

In all cases, adding irrigation demands without practicing wastewater reuse would impart large increases in the 2011 backup supply requirements, and would also greatly increase the number of other years in which backup supply would be required. For brevity in reporting the modeling results at each location, only the 2011 backup supply requirements are reported, except in the few cases where the largest amount of backup supply was required in another year, which are noted.

The modeling results when adding on irrigation demands *with* wastewater reuse to defray irrigation demand show an increase in backup supply requirements in 2011 of zero to a few truckloads. In other years, there was typically either no increase or a 2,000-gallon increase. In almost all cases when wastewater reuse is practiced, the modeling results for the curtailment scenario show either no increase of backup supply requirements or an increase of 2,000 gallons. In these scenarios, irrigation – except with reclaimed water – ceases when the cistern water volume drops below the alarm level, and there is also curtailment of interior use, as reviewed above.

Under the wastewater reuse option, the increase due explicitly to irrigation demand could readily be avoided by simply curtailing as needed supplemental irrigation with rainwater, irrigating *only* with reclaimed wastewater. Here again, the conundrum is knowing when one is approaching a prolonged drought, but clearly this sort of curtailment could be started at any time. As noted previously, one could avoid a need for any water directly out of the cistern for irrigation by installing a native plant landscape, rather than high water use plants, which would typically do well irrigated with only wastewater flow. This highlights that a landscape ethic which fits with the RWH water supply strategy perhaps should be part and parcel of the overall strategy. This matter is addressed in Section IX, dealing with sustainability.

Validation of the Monthly Model

A month is quite a long time step relative to the dynamics of flow into and out of the cistern due to rainfall inputs and water usage in the house. It therefore may be brought to question if a model employing a month-long time step would accurately reflect when and how much the cistern would overflow or when backup supply would be needed. In order to validate the monthly model, the results it produces were compared to a model using daily time steps.

Due to the time required to enter daily rainfalls into a daily model, a readily available set of daily rainfall data from the Austin weather station for only the years 1987-1997 was used for this evaluation. To assure that the two rainfall data sets were essentially the same, the monthly totals of the data in the daily model were compared to the monthly rainfall totals input to the monthly model, and they were observed to be equivalent.

Six RWH system configurations were evaluated, generally covering the range of configurations for the Austin station that are evaluated in this section. The results are shown in Table N1. As noted previously, the critical piece of information is the amount of backup water supply required, as this will determine the practical viability of the overall water supply strategy. Also shown is the percent of demand derived from roof runoff (total water usage minus backup supply divided by total usage) and, as an additional check on the accuracy of the projections, the percent of the roof runoff (listed as rainfall in the table) that was lost to overflow.

Table N1: Comparison of Monthly and Daily Rainfall Modeling Results: Austin Rainfall Data, 1987-1997.

System Configuration and Demand Profile:						
Roofprint = 2,500 ft ² ; Cistern size = 15,000 gallons ; Daily demand = 100 gallons per day						
	Monthly Model Results			Daily Model Results		
<u>Year</u>	Backup Water Supply Req. (gallons)	% Demand From Rainwater	% Total rainfall lost to overflow	Backup Water Supply Req. (gallons)	% Demand From Rainwater	% Total rainfall lost to overflow
1987	0	100	23	0	100	24
1988	0	100	0	0	100	0
1989	0	100	0	0	100	3
1990	0	100	0	0	100	0
1991	0	100	49	0	100	49
1992	0	100	47	0	100	48
1993	0	100	33	0	100	32
1994	2,000	95	27	2,000	95	28
1995	0	100	33	0	100	35
1996	0	100	12	0	100	13
1997	0	100	48	0	100	47
TOTALS	2,000			2,000		
System Configuration and Demand Profile:						
Roofprint = 2,500 ft ² ; Cistern size = 20,000 gallons; Daily demand = 125 gallons per day						
	Monthly Model Results			Daily Model Results		
<u>Year</u>	Backup Water Supply Req. (gallons)	% Demand From Rainwater	% Total rainfall lost to overflow	Backup Water Supply Req. (gallons)	% Demand From Rainwater	% Total rainfall lost to overflow
1987	0	100	6	0	100	8
1988	4,000	91	0	6,000	87	0
1989	8,000	82	0	6,000	87	0
1990	4,000	91	0	4,000	91	0
1991	0	100	20	0	100	21
1992	0	100	38	0	100	38
1993	0	100	14	0	100	15
1994	6,000	87	12	6,000	87	12
1995	0	100	18	0	100	19
1996	0	100	0	0	100	0
1997	0	100	27	0	100	28
TOTALS	22,000			22,000		
System Configuration and Demand Profile:						
Roofprint = 3,500 ft ² ; Cistern size = 20,000 gallons; Daily demand = 125 gallons per day						
	Monthly Model Results			Daily Model Results		
<u>Year</u>	Backup Water Supply Req. (gallons)	% Demand From Rainwater	% Total rainfall lost to overflow	Backup Water Supply Req. (gallons)	% Demand From Rainwater	% Total rainfall lost to overflow
1987	0	100	19	0	100	20
1988	0	100	0	0	100	0
1989	0	100	0	0	100	0
1990	0	100	0	0	100	0
1991	0	100	41	0	100	43
1992	0	100	45	0	100	45
1993	0	100	31	0	100	30
1994	2,000	96	23	2,000	96	24
1995	0	100	30	0	100	33

1996	0	100	9	0	100	9
1997	0	100	46	0	100	45
TOTALS	2,000			2,000		

System Configuration and Demand Profile:

Roofprint = 4,000 ft²; Cistern size = 30,000 gallons; Daily demand = 200 gallons per day

Year	Monthly Model Results			Daily Model Results		
	Backup Water Supply Req. (gallons)	% Demand From Rainwater	% Total rainfall lost to overflow	Backup Water Supply Req. (gallons)	% Demand From Rainwater	% Total rainfall lost to overflow
1987	0	100	7	0	100	9
1988	8,000	89	0	10,000	86	0
1989	10,000	86	0	10,000	86	0
1990	8,000	89	0	8,000	89	0
1991	0	100	20	0	100	23
1992	0	100	38	0	100	38
1993	0	100	14	0	100	15
1994	10,000	86	12	12,000	84	14
1995	0	100	18	0	100	19
1996	0	100	0	2,000	97	0
1997	0	100	27	0	100	29
TOTALS	36,000			42,000		

System Configuration and Demand Profile:

Roofprint = 4,500 ft²; Cistern size = 35,000 gallons; Daily demand = 200 gallons per day

Year	Monthly Model Results			Daily Model Results		
	Backup Water Supply Req. (gallons)	% Demand From Rainwater	% Total rainfall lost to overflow	Backup Water Supply Req. (gallons)	% Demand From Rainwater	% Total rainfall lost to overflow
1987	0	100	13	0	100	14
1988	0	100	0	0	100	0
1989	0	100	0	0	100	0
1990	2,000	97	0	2,000	97	0
1991	0	100	29	0	100	30
1992	0	100	42	0	100	42
1993	0	100	26	0	100	27
1994	2,000	97	16	2,000	97	16
1995	0	100	25	0	100	28
1996	0	100	3	0	100	3
1997	0	100	42	0	100	41
TOTALS	4,000			4,000		

System Configuration and Demand Profile:

Roofprint = 5,000 ft²; Cistern size = 40,000 gallons; Daily demand = 250 gallons per day

Year	Monthly Model Results			Daily Model Results		
	Backup Water Supply Req. (gallons)	% Demand From Rainwater	% Total rainfall lost to overflow	Backup Water Supply Req. (gallons)	% Demand From Rainwater	% Total rainfall lost to overflow
1987	0	100	6	0	100	8
1988	6,000	93	0	8,000	91	0
1989	14,000	85	0	14,000	85	0
1990	10,000	89	0	8,000	91	0
1991	0	100	18	0	100	20
1992	0	100	38	0	100	38
1993	0	100	14	0	100	15

1994	8,000	91	8	12,000	87	12
1995	0	100	18	0	100	19
1996	0	100	0	0	100	0
1997	0	100	27	0	100	28
TOTALS	38,000			42,000		

As Table N1 shows, there is very good agreement between the projections provided by the monthly and daily models. The total number of comparisons among all the models is 66, 11 years in each of the six model runs. In 58 instances, the projection of backup demand required is identical. In seven instances, it differs by one 2,000-gallon tanker truck load per year, and in one instance it differs by 4,000 gallons, or 2 truckloads. In two instances where the difference is 2,000 gallons, the monthly model produces the higher projection, and the daily model produces the higher projection in the other five instances. In one case, the difference is due to a truckload being required in December of one year in the daily model and in January of the following year in the monthly model, with the two-year total being the same. In the instance where the difference is 4,000 gallons, the daily model produces the higher projection. The maximum total difference in projected backup supply requirement over the 11 years in any one model is 6,000 gallons, 3 truckloads.

In 53 instances, the percentage of overflow is identical or differs by one percent, which may simply be rounding error. In eight instances, the difference is 2 percent, in four instances it is 3 percent, and in one instance it is 4 percent. In all of the 13 instances where the difference is greater than 1 percent, the daily model projection is the higher of the two. It is therefore concluded that, particularly given the various uncertainties in this modeling process, the monthly model provides projections of backup demand requirements that are acceptably accurate for the purposes of this analysis.

Roof Runoff Capture Rate

As previously stated, the RWH model presumes that roof runoff rate is 0.6 gallons per inch of rainfall per square foot of roofprint. With the theoretical maximum capture rate being 0.623 gal/in/ft² (1/12 ft³ per ft² x 7.48 gal/ft³), this is an average effective capture efficiency of 96.3%. Losses are due to application of a runoff coefficient and to wind effects and evaporation losses off a hot roof, particularly for small rainfall events.

Regarding runoff coefficient, studies indicate that metal roofs – the most recommended roof material for RWH systems – exhibit a very low abstraction (retention of water, lowering the portion of water falling onto the roof that runs off). An example of a runoff coefficient is the Soil Conservation Service (SCS) method curve number (CN). A value of 98 is presumed for pavement, dictating that only a very small amount of the rainfall onto the surface would be abstracted and the rest would run off. The runoff coefficient for a sloping metal roof would be higher, as metal is a much smoother surface.

The RWH user whose water use information was reviewed above – whose house does have a metal roof – reported that in some rainfall events, his capture rate appeared to be ~0.45 gal/in/ft². However, in a gentle day-long 0.9 inch rain event in low wind conditions, the capture rate was

indeed 0.6 gal/in/ft², appearing to confirm the basic validity of the assumed capture rate. The conditions of that system were not evaluated to ascertain the factors that led to lower capture rates over other observation periods. Reductions in capture rate may have been due to inaccurate measurement of rainfall, gutter overflow during high intensity events, losses off roof edges, inaccurate accounting of cistern overflows, etc.

It may be, however, that the major factor is roof orientation and pitch relative to prevailing wind direction. It has been asserted that this can have significant impact on the capture rate, but to date definitive research on this factor has not been located. The house of that RWH user noted above does have high-pitched roofs, which are expected to be more prone to wind effects. This is a factor to bear in mind when reviewing the modeling results, since a lower capture rate might create greater requirements for backup supply than are projected by the model. This is noted as an item apparently in need of further research.